

HomeCleaningSystem
Oxygen
by **EUREKA**

Home Cleaning System Vacuum Cleaner

Household Type

Owner's Guide Model 6992 & 6996



www.eureka.com

Index	
Important Safeguards	2
Service Information	4
Thermal Cut Off	4
Assembly	5
Use	6-7
Dust Bag	8
Filter	8
Belt	9
Light Bulb	9
Warranty	10
Customer Order Form	11

IMPORTANT SAFEGUARDS

When using an electrical appliance, basic precautions should always be followed, including the following:

READ ALL INSTRUCTIONS BEFORE USING THIS VACUUM CLEANER.

WARNING

To reduce the risk of fire, electric shock, or injury:

- Do not use outdoors or on wet surfaces.
- **Do not leave vacuum cleaner when plugged in.** Turn off the switch and unplug the electrical cord when not in use and before servicing.
- Do not allow to be used as a toy. Close attention is necessary when used by or near children.
- Use only as described in this manual. Use only manufacturer's recommended attachments.
- Do not use with damaged cord or plug. If vacuum cleaner is not working as it should, has been dropped, damaged, left outdoors, or dropped into water, return it to a service center before using.
- Do not pull or carry by cord, use cord as a handle, close a door on cord, or pull cord around sharp edges or corners. Do not run vacuum cleaner over cord. Keep cord away from heated surfaces.
- Hold plug when rewinding onto cord reel. Do not allow plug to whip when rewinding.
- Do not use extension cords or outlets with inadequate current carrying capacity.
- Turn off all controls before unplugging.
- Always turn off this appliance before connecting or disconnecting either hose or motorized nozzle.
- Do not unplug by pulling on cord. To unplug, grasp the plug, not the cord.
- The hose contains electrical wires. Do not use if damaged, cut or punctured. Avoid picking up sharp objects.
- Do not handle plug or vacuum cleaner with wet hands.
- Do not put any object into openings. Do not use with any opening blocked; keep free of dust, lint, hair, and anything that may reduce airflow.
- This vacuum cleaner creates suction and may contain a revolving brush roll. Keep hair, loose clothing, fingers, and all parts of body away from openings and moving parts.
- Do not pick up anything that is burning or smoking, such as cigarettes, matches, or hot ashes.
- Do not use without dust bag in place.
- Belt pulleys can become hot during normal use. To prevent burns, avoid touching the belt pulley when servicing the drive belt.
- Use extra care when cleaning on stairs.
- Do not use to pick up flammable or combustible liquids such as gasoline, or use in areas where they may be present.
- Store your cleaner in a cool, dry area.
- Keep your work area well lighted.
- Unplug electrical appliances before vacuuming them.

SAVE THESE INSTRUCTIONS

CONSEILS DE SÉCURITÉ

Lors de l'utilisation d'un appareil électrique, quelques précautions élémentaires doivent être observées, incluant les suivantes:

LISEZ TOUTES LES INSTRUCTIONS AVANT D'UTILISER VOTRE ASPIRATEUR.

AVERTISSEMENT

Pour réduire le risque de feu, de choc électrique, ou de blessure:

- Ne pas utiliser à l'extérieur ou sur des surfaces mouillées.
- **Fermez le commutateur et débranchez l'appareil lorsque vous ne l'utilisez pas ou avant le nettoyage ou l'entretien.**
- Ne permettez pas qu'il soit utilisé comme jouet. Une attention particulière est nécessaire lorsque utilisé par ou près d'un enfant.
- Suivez les recommandations d'utilisation de ce manuel. Utilisez uniquement les accessoires recommandés par le fabricant.
- Ne pas utiliser si le cordon ou la fiche sont endommagés. Si l'aspirateur ne fonctionne pas comme il le devrait, s'il a été échappé, s'il est endommagé, s'il a été laissé à l'extérieur ou échappé dans l'eau, retournez-le à un centre de service avant d'utiliser.
- Ne pas le tirer ou le transporter par le cordon, ne pas utiliser le cordon un guise de poignée. Ne pas fermer une porte sur le cordon ou tirer le cordon sur des coins ou bordures pointus. Ne pas circuler sur le cordon avec l'aspirateur. Tenir le cordon à distance des surfaces chauffantes.
- Tenir la fiche lorsque vous rebobinez le cordon électrique. Ne pas permettre que la fiche batte l'air.
- Ne pas utiliser des rallonges ou des prises qui n'ont pas de capacité suffisante pour transporter le courant.
- Éteindre toujours l'appareil avant de connecter ou de déconnecter le tuyau ou la lance motorisée.
- Fermer tous les contrôles avant de débrancher.
- Le tuyau contient des fils électriques et ne doit pas être utilisé s'il est abîmé, coupé ou percé. Éviter de ramasser les objets aigus.
- Ne pas débrancher en tirant sur le cordon. Pour débrancher, tenez la fiche et non le cordon.
- Ne pas manipuler la fiche ou l'aspirateur avec les mains mouillées.
- Ne pas rien insérer dans les ouvertures. Ne pas utiliser si des ouvertures sont bloquées; assurez-vous qu'elles soient dégagées de poussière, mousse, cheveux ou toute autre chose qui pourrait réduire le passage de l'air.
- Cet aspirateur crée de la succion et contient un rouleau-brosse tournant. Tenir les parties mobiles et les ouvertures loin des cheveux, du linge, des doigts et de toute partie du corps.
- Ne pas ramasser des objets qui brûlent ou fument comme les cigarettes, allumettes ou cendres chaudes.
- N'utilisez pas sans le sac de poussière en place.
- Les poulies du courroie peuvent devenir chaudes pendant l'utilisation normale. Pour prévenir des brûlures, évitez de touché la poulie du courroie lorsque vous réparez la courroie.
- Portez une attention particulière lorsque vous nettoyez les escaliers.
- Ne pas utiliser pour ramasser des liquides inflammables ou combustibles comme de l'essence. Ne pas utiliser dans les endroits où ces liquides pourraient être présents.
- Entrez votre aspirateur à l'intérieur dans un endroit propre et sec.
- Maintenez un bon éclairage à l'endroit où vous travaillez.
- Débrancher les appareils électrique avant de les balayer.

CONSERVEZ CES INSTRUCTIONS

To reduce the risk of electric shock, this appliance has a polarized plug (one blade is wider than the other). The plug will fit in a polarized outlet only one way. If the plug does not fit fully in the outlet, reverse the plug. If it still does not fit, contact a qualified electrician to install the proper outlet. Do not change the plug in any way.

Afin de réduire le risque de choc électrique, cet appareil est muni d'une fiche polarisée (une des lames est plus large). Cette fiche ne peut être insérée dans une prise polarisée que d'une seule façon. Si la fiche ne peut être insérée dans la prise, retourner la fiche. Si la fiche ne peut toujours pas être insérée dans la prise, faire installer une prise adéquate par un électricien qualifié. Ne pas modifier la fiche.

GENERAL INFORMATION

The bag may have come dislodged in shipping. Check the bag to insure proper seating before attempting to use the cleaner. Do not operate the cleaner without a dust bag or the filters. Damage may result to the motor (see Dust Bag and Filter).

The cleaner is designed to pick up dirt and dust particles. Avoid picking up hard or sharp objects with the cleaner to avoid bag breakage, hose clogging, or possible motor damage.

Service Information

The instructions in this booklet serve as a guide to routine maintenance. If additional service is required, telephone toll free:

USA: 1-800-282-2886
Mexico: 5670-6169
Canada: 1-800-282-2886

If you prefer, you can write to The Eureka Company, Service Division, 807 N. Main Street, Bloomington, Illinois 61701, USA. The Eureka Company, 866 Langs Drive, Cambridge, Ontario N3H 2N7. Refer to The Eureka Limited Warranty for complete service information.



DO NOT OIL the motors (in the canister and the motorized nozzle) or the brush roll at any time. The bearings are permanently lubricated and sealed.

Rating Plate

The model, type and serial numbers are indicated on the rating plate located on the underneath side of the cleaner. For prompt and complete service information, always refer to these numbers when inquiring about service.

Model No. & Type _____

Serial No. _____

MADE IN SWEDEN		THE EUREKA COMPANY BLOOMINGTON, IL 61701 SERVICE INFORMATION: 1-800-282-2886	
MODEL	TYPE	SERIAL NO.	
HOUSEHOLD TYPE	TYPE MENAGER	120 V 60 HZ	AMPS 12.0

Thermal Cut Off

This vacuum cleaner has a special thermostat that protects the cleaner in case of motor overheating. If the cleaner suddenly shuts off, push the switch pedal once and unplug the cleaner. Check the cleaner for a possible source of overheating such as a blocked hose or clogged filter. If these conditions are found, fix them and wait at least 30 minutes before attempting to use the cleaner. After the 30 minute period, plug the cleaner back in and turn on the switch. If the cleaner still does not run, call a Eureka Service Station.

ASSEMBLY ITEMS

NOTE: Unpack and identify all parts. Fully assemble before using.

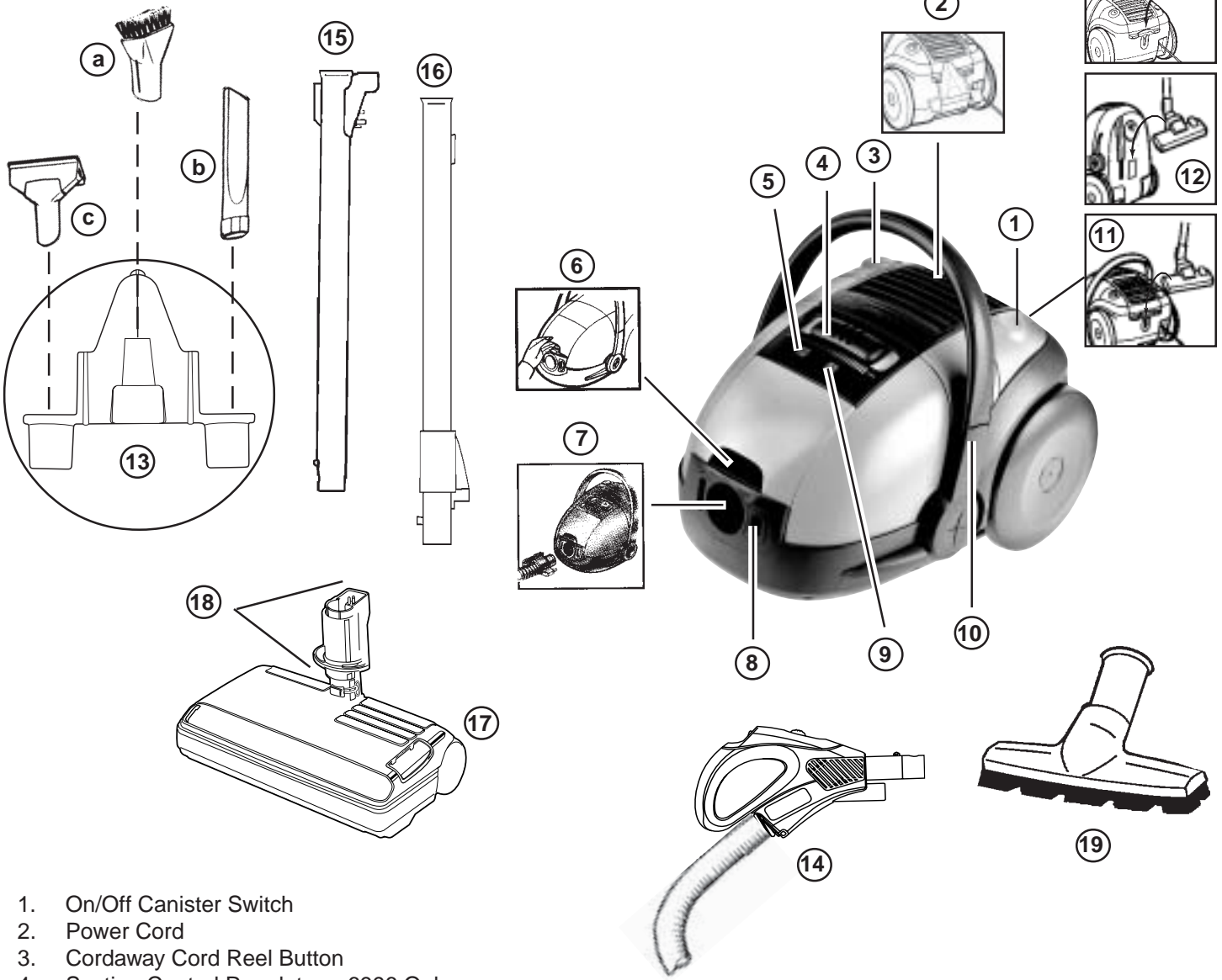

1. On/Off Canister Switch
2. Power Cord
3. Cordaway Cord Reel Button
4. Suction Control Regulator – 6996 Only
5. HEPA Filter Full Indicator – 6996 Only
6. Cover Release for Dust Compartment
7. Hose Connection
8. Power Outlet
9. Dust Bag Full Indicator
10. Carrying Handle
11. Temporary parking position for floor nozzle and wands when in use.
12. Storage slot for floor nozzle and wands, or tool caddy.
13. Tool Caddy
 - a) Dusting Brush
 - b) Crevice Tool
 - c) Upholstery Nozzle
14. Hose has Power-Touch Handle with nozzle on/off control. See instructions on pages 6 and 7.
15. Button-Lock Extension Wand with plug retainer
16. Button-Lock Extension Wand with cord retainer
17. Motorized Nozzle
18. Quick Release™ Wand System
19. Floor Brush

NOTE: Be careful when cleaning steps, etc.

How to Assemble and Use

POWER-TOUCH® Handle

Remote ON/OFF Selector for bare floor or carpet

- Carpet** – Turn on motorized nozzle.
- Bare Floor** – Turn off motorized nozzle.

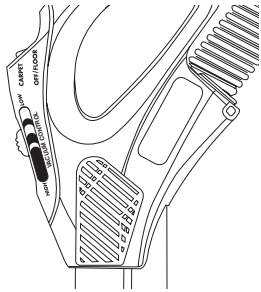

Vacuum Control

Cleaning suction is reduced by pushing lever to LOW position. Place lever at HIGH position to increase suction for carpet cleaning.

1. Snap interlocking wands together.
2. Push assembled wands into the quick release socket attached to the power nozzle.
3. Push motorized nozzle plug into the retainer located at the top of the upper wand; secure cord in slot (Detail A).
4. Place Power-Touch hose handle into wands until plug connects and button locks.

Continue on next page to complete assembly.

Step here & pull up to release

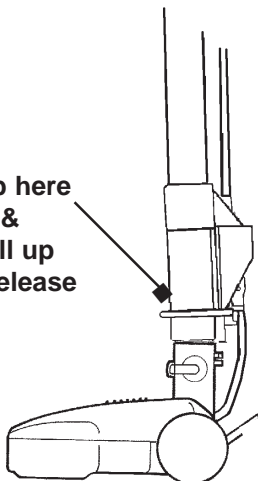

Motorized Nozzle

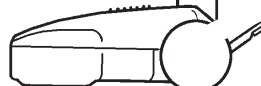

Motorized Nozzle

9 Select bare floor or carpet cleaning

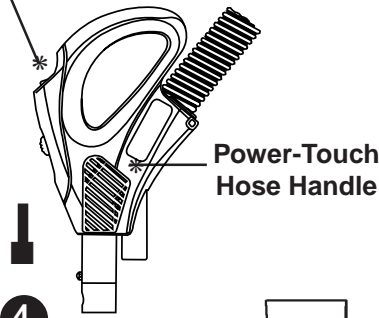

Power-Touch Hose Handle

4

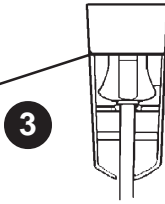

Detail A

3

1

2

Quick Release Lower Assembly

If you purchased the Dirt Sensor model, your lower wand will look like this.

Dirt Sensor (Model 6996 only)

NOTE: Dirt sensor works most effectively when suction control regulator on canister and vacuum control on handle are both on **HIGH**.

How to Assemble and Use (continued)



5. Insert hose coupling into front of canister.

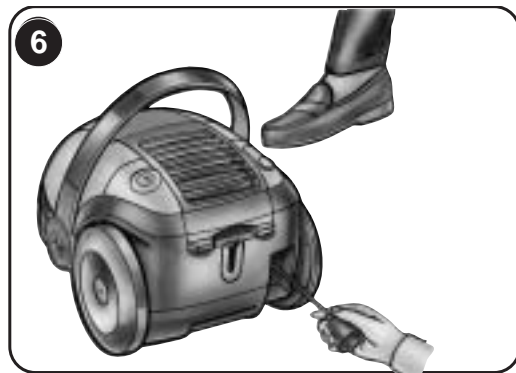

6. Pull cord out until fully extended, and push plug into outlet. To rewind, step on Cordaway cord reel button, hold and guide plug while it rewinds.

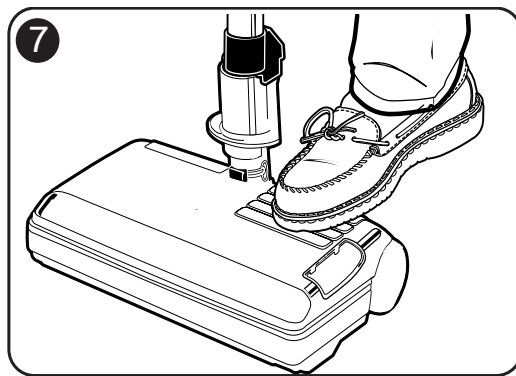

7. Step on motorized nozzle to release handle; pull back to comfortable work position.

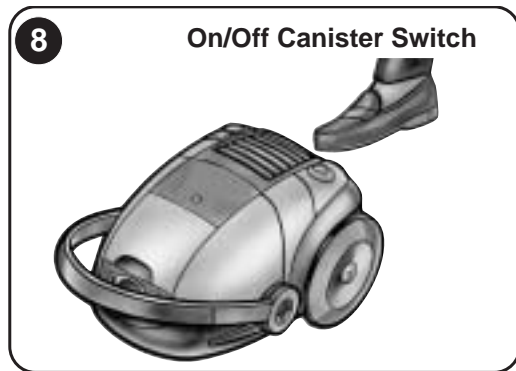

8. Push On/Off canister switch.
(A thermostat automatically shuts off the motor if it overheats, see Thermal Cut Off.)

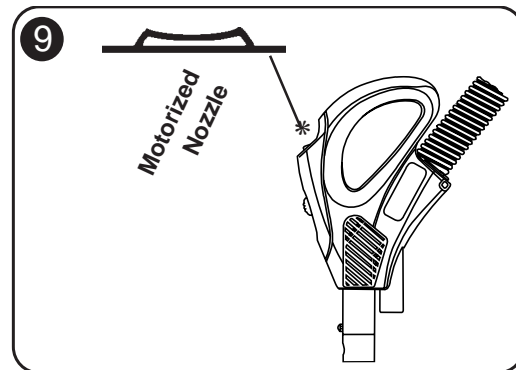

9. Bare floor or carpet cleaning selection on remote control, only.

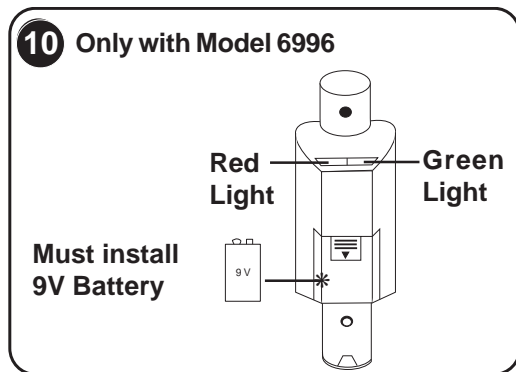

10. Red light indicates dirt, dust, etc. is still being removed from the area being cleaned. The green light indicates the area is clean and to move on to the next area.

NOTE: Dirt sensor works most effectively when suction control regulator on canister and vacuum control on handle are both on **HIGH**.

HINT: New carpeting has loose carpet fibers which will activate the red light sensor beam.

HOW TO MAINTAIN

The paper bag and filter play a very important role in the efficiency of the vacuum cleaner. The purpose of the paper bag is to trap dirt and at the same time the paper must be porous enough to allow air to pass through. If the paper bag or filter become clogged, no air can pass through the cleaner and no cleaning takes place regardless of how powerful the unit. To keep the cleaner operating at maximum efficiency, change the dust bag frequently and clean the filter as necessary.

Some fine particles can restrict airflow very quickly and will decrease performance even before the bag appears to be full. When vacuuming carpet fresheners or cleaners, plaster dust, or similar fine substances, clean the bag and filter more often.

NOTE: Turn off the power switch and disconnect electrical plug from wall socket before changing dust bag. Never use the cleaner without a dust bag or filters.

HOW TO CHANGE DISPOSABLE DUST BAG

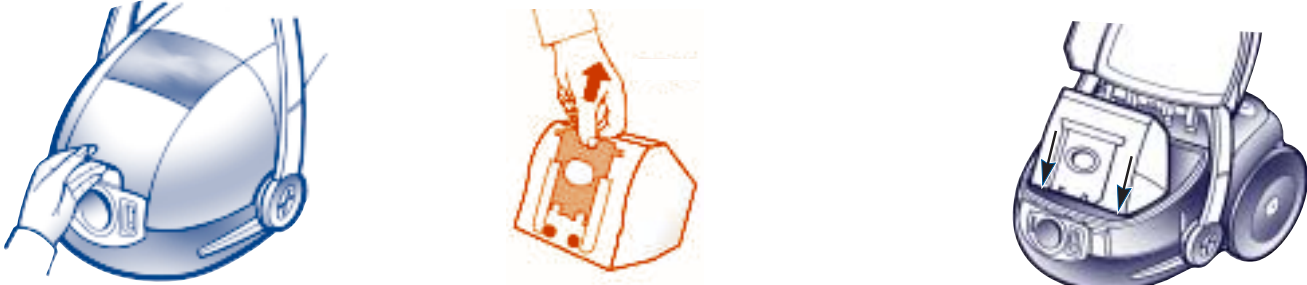

Open cleaner cover.

Pull the sliding tab to remove dust bag.

Insert new dust bag by sliding the bag slots into the holder. Close cover.

Use GENUINE EUREKA replacement bag, 61230. **NOTE: Lid will not latch if dust bag is not installed.**

HOW TO CHANGE MOTOR FILTER



Open cleaner cover.

Remove filter and covering strip.

Important: Insert new filter into original covering strip. Then install filter with covering strip securely in place. Close cover.

Use GENUINE EUREKA replacement motor filter, 61263. The motor filter can be cleaned. Run under water and allow to thoroughly air dry. **NOTE: Lid will not latch if dust bag is not installed.**

HOW TO CHANGE HEPA FILTER AND FINAL FILTER

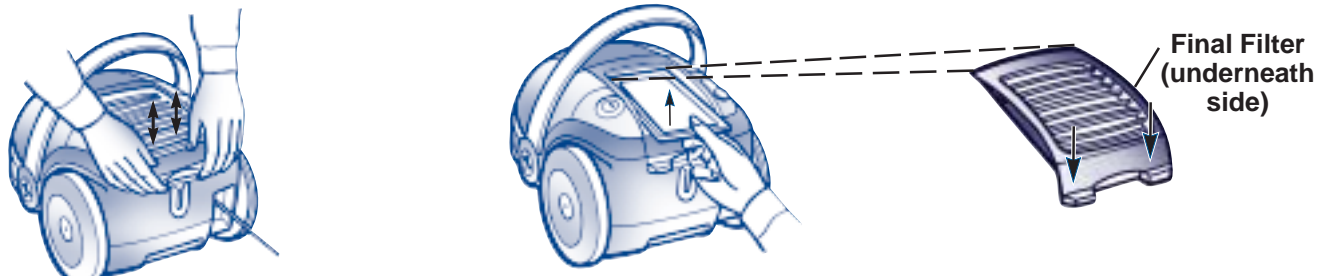

Open filter cover by lifting up on latches and pulling filter cover out and away from the cleaner.

Replace old HEPA filter with new HEPA filter. Clean or replace final filter in filter cover and close cover.

Ensure the filter cover is securely fastened.

Final Filter (underneath side)

Use GENUINE EUREKA HEPA filter, 60286A. We recommend the HEPA filter be changed every 6 months or as needed. Use GENUINE EUREKA Final filter, 61262. The final filter can be cleaned. Run under water and allow to thoroughly air dry.

How To Change or Clean Washable HEPA Filter and Final Filter (Model 6996 only)

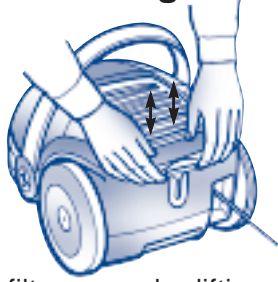

Open filter cover by lifting up on latches and pulling filter cover out and away from the cleaner.

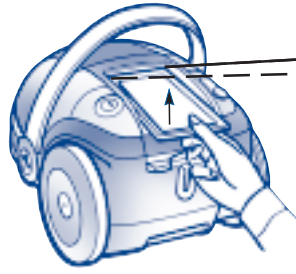

Clean or replace washable HEPA filter. Clean or replace final filter in filter cover and close cover.

Final Filter (underneath side)

Ensure the filter cover is securely fastened.

Use GENUINE EUREKA washable HEPA filter, 61053. To clean filter rinse dirty side of filter under warm, low pressure water being careful not to get the clean side wet (this increases drying time). Do not put damp filter back in vacuum cleaner. Allow to thoroughly air dry.



Use GENUINE EUREKA Final filter, 61262. The final filter can be cleaned. Run under water and allow to thoroughly air dry.

How to Replace Worn Belt or Light Bulb

NOTE: Disconnect power cord and wands from electrical hose before replacing belt or bulb. Belt pulleys can become hot during normal use. To prevent burns, avoid touching the belt pulley when servicing the drive belt.

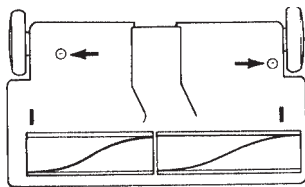

1. Remove two screws from bottom side. To turn over, grasp hood near handle socket and lift forward.

Replace headlight bulb (on some models), if necessary. Support socket with one hand and push light bulb into socket; turn to release. Place new light bulb into socket; turn to secure. Push light bulb and socket back so bulb will not touch lens cover. Use GENUINE EUREKA replacement bulb, 59224.

Continue to step 2 to change belt. Skip to step 7 and 8 to replace hood on motorized nozzle.

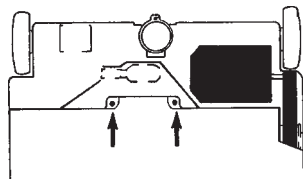

2. Remove two screws located in front of the light bulb and lift up to remove the brush roll cover.

Motor Shaft

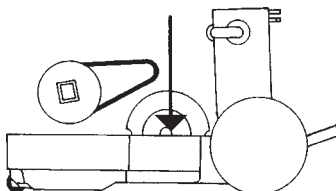

3. Lift out brush roll; replace new belt around brush roll shaft.

4. Return brush roll into base.

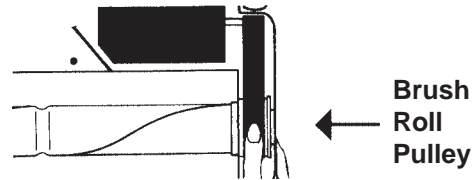
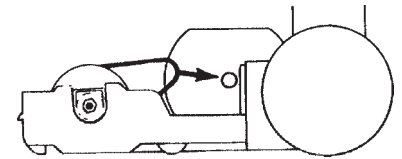

5. Rotate belt onto motor pulley.
6. Replace brush roll cover.

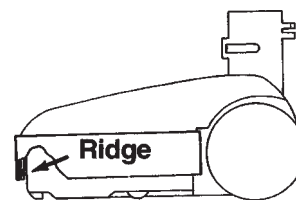

7. Tilt cover over ridge and push down.
8. Secure with screws on underside (refer to 1).

Use GENUINE EUREKA replacement belt, 52201C.

THE EUREKA LIMITED WARRANTY

Exclusive 5 Year Motor Coverage

This product's motor is warranted to be free from all defects in material and workmanship in normal household use for a period of five years. The warranty is granted only to the original purchaser and members of his or her immediate household. The warranty is subject to the following provisions.

Additional Warranty Coverage

Your Eureka cleaner is warranted to be free from all defects in material and workmanship in normal household use for a period of one year. The warranty is granted only to the original purchaser and members of his or her immediate household. The warranty is subject to the following provisions.

What This Warranty Does Not Cover

- Parts of the cleaner that require replacement under normal use, such as disposable dust bags, filters, drive belts, light bulbs, and brush roll bristles
- Damages or malfunctions caused by negligence, abuse, or use not in accordance with the Owner's Guide.
- Defects or damages caused by unauthorized service or the use of other than Genuine Eureka parts.

What The Eureka Company Will Do

The Eureka Company will, at its option, repair or replace a defective cleaner or cleaner part that is covered by this warranty. As a matter of warranty policy, the Eureka Company will not refund the consumer's purchase price.

Warranty Registration

Please fill out and return the warranty registration card accompanying your cleaner.

Obtaining Warranty Service

To obtain warranty service you must return the defective cleaner or cleaner part along with proof of purchase to any Eureka Authorized Warranty Station. You will find the nearest location in the Yellow Pages, under "Vacuum Cleaners—Service and Repair." Be certain that the Warranty Station is "Eureka Authorized." For the location of the nearest Eureka Authorized Warranty Station or for service information, telephone toll free:

USA: 1-800-282-2886

Mexico: 5670-6169

Canada: 1-800-282-2886

If you prefer, you can write to The Eureka Company, Service Division, 807 N. Main Street, Bloomington, Illinois 61701, USA. In Canada write to The Eureka Company, 866 Langs Drive, Cambridge, Ontario N3H 2N7.

If it is necessary to ship the cleaner outside your community to obtain warranty repair, you must pay the shipping charges to the Eureka Authorized Warranty Station. Return shipping charges will be paid by the Warranty Station. When returning parts for repair, please include the model, type, and serial number from the data plate on the cleaner.

Further Limitations and Exclusions

Any warranty that may be implied in connection with your purchase or use of the cleaner, including any warranty of Merchantability or any warranty for Fitness For A Particular Purpose is limited to the duration of this warranty. Some states do not allow limitations on how long an implied warranty lasts, so the above limitations may not apply to you.

Your relief for the breach of this warranty is limited to the relief expressly provided above. In no event shall Eureka be liable for any consequential or incidental damages you may incur in connection with your purchase or use of the cleaner. Some states do not allow the exclusion or limitation of incidental or consequential damages, so the above limitation or exclusion may not apply to you.

This warranty gives you specific legal rights. You may also have other rights which vary by state.



Questions & Answers about Genuine Eureka Products

Q: Why should I use only Genuine Eureka paper bags, belts, and parts in my Eureka vacuum cleaner?

A: Using Genuine Eureka Products, which are made to our exacting specifications and engineered with emphasis on quality, performance, and customer satisfaction, ensures the long life and cleaning efficiency of your vacuum cleaner. Overall, this saves you money and helps to keep your home clean.

Q: How can I be sure I am using only genuine Eureka products in my vacuum cleaner?

A: Typically, packaged products and paper bags can be identified by a "Genuine Eureka Product" symbol (see illustration above). For further identification assistance, you may call our toll-free number, 1-800-282-2886, for the location of a nearby Eureka Authorized Warranty Station.

Q: Are there any differences between "made to fit" or "imitation" and Genuine Eureka paper bags, belts, and parts?

A: Yes, there are some very important differences in materials, quality, and reliability. Many customers have mistakenly purchased "imitation" paper bags and parts while thinking they purchased genuine. Unfortunately, many of these customers discovered the differences after they experienced related difficulties.

For Genuine Eureka Value, Accept No Imitations!

THE EUREKA COMPANY

Bloomington, Illinois 61701

Household Warranty
abs 190



The Eureka Company
 P.O. Box 2799
 Bloomington, IL 61702-2799

ORDER FORM

(Not applicable in Canada)

S
O
L
D
T
O

Name			
Address (street address needed for UPS)			
City	State	Zip	
Telephone (Day)	(Eve)	(Fax)	

S
H
I
P
T
O

Name			
Address (street address needed for UPS)			
City	State	Zip	
Telephone (Day)	(Eve)	(Fax)	

IMPORTANT:
 Be sure to include your model, type, and serial numbers. These numbers may be found on the rating plate.

Model Number: _____

Type: _____

Serial Number: _____

To Order



By Phone
1-800-438-7352*

HOURS:
 Call between 8 a.m. and 4:45 p.m., central standard time Monday through Friday.

By FAX
1-309-823-5789

To Answer Problems or Questions for U.S.A. and Canada call:
1-800-282-2886*
 7 a.m. to 8 p.m. central standard time Monday through Saturday.

*En Mexico llame al **5670-6169**

By Mail



Simply fill out this Order Form. Please be sure to include day and evening phone numbers.

www.eureka.com

Genuine Eureka Bags, Belts and Filters		Part No.	Qty.	Price (USD)	Total
	Disposable Bags (style OX) - package of 3	61230A		4.99	
	Motor Filter	61263		4.19	
	Final Filter (6994, 6997, 6999)	61262		4.19	
	Final Filter (6991, 6992, 6996)	61895		4.19	
	HEPA Filter - Style HF1 (6991, 6992, 6994, 6997)	60286A		19.99	
	Washable HEPA Filter (6996, 6999)	61053		29.99	
	Belt - package of 2 (6992, 6996, 6997, 6999)	52201C		2.49	

Accessories/Tools		Part No.	Qty.	Price (USD)	Total
	Dusting Brush	60290-1		5.59	
	Upholstery Nozzle	22713-9		5.79	
	Crevice Tool	27237-3		2.69	
	Deluxe Floor Nozzle (6992, 6996, 6997, 6999)	60816		14.99	
	Floor Tool (6991, 6994)	61264		44.99	
	Tool Caddy	72040		2.99	
	Mini Turbo (6996, 6999)	28612A		14.99	
	Upper Wand (6992, 6996, 6997, 6999)	37738-8		6.99	
	Lower Wand for attachments (6996, 6999)	36879-5		9.99	
	Lower Wand with Sensor (6996, 6999)	39040A-4		65.99	
	Lower Wand without Sensor (6992, 6997)	39040A-2		18.59	
	Telescopic Wand Set (6991)	61909		56.99	
	Swivel Hose Assembly (6992, 6996, 6997, 6999)	61054-2		77.69	
	Hose Assembly (6991, 6994)	61908		59.99	
	Light Bulb (6996, 6997, 6999)	59224		3.79	
	Brush Roll (6992)	54419-1		25.39	
	Brush Roll (6996, 6997, 6999)	53411-2		43.19	

Total (prices subject to change without notice)	
Tax (add state tax & local taxes as required by law)	
Postage & Handling Charge (within U.S.A.)	\$5.50
TOTAL	
TOTAL ENCLOSED	

Method of payment (No C.O.D. Orders)

- Check or money order (payable to The Eureka Company). Do not send currency.
 Charge to my Visa (13/15 digits) MasterCard (13 digits) Amer. Express (15 digits)

Acct. number	Expiration Date
Signature (full name as shown on acct.)	

Free Manuals Download Website

<http://myh66.com>

<http://usermanuals.us>

<http://www.somanuals.com>

<http://www.4manuals.cc>

<http://www.manual-lib.com>

<http://www.404manual.com>

<http://www.luxmanual.com>

<http://aubethermostatmanual.com>

Golf course search by state

<http://golfingnear.com>

Email search by domain

<http://emailbydomain.com>

Auto manuals search

<http://auto.somanuals.com>

TV manuals search

<http://tv.somanuals.com>