

Flymo

Multi-Trim

Revolution

 Electrolux

TRIM MODE

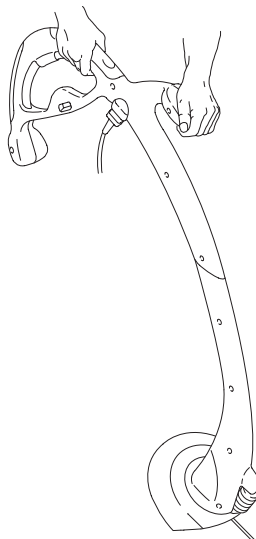

EDGE MODE

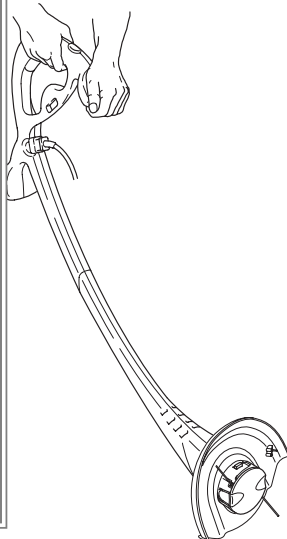

TURN OVER
TO EDGE



IMPORTANT INFORMATION
Read before use
& retain for future reference



Carton Contents

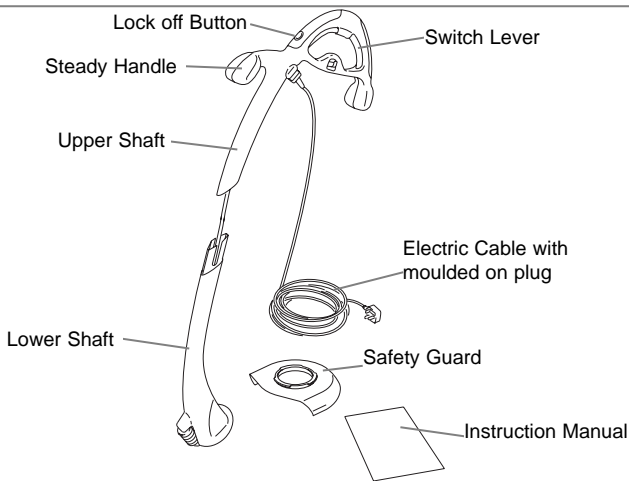

IMPORTANT !

Please check the contents of the carton are correct **BEFORE** assembling your new Flymo product.

IF ANY PARTS ARE MISSING CONTACT:-

Electrolux Outdoor Products Customer Service Department direct

Telephone : 01325 300303

Fax : 01325 318193

Safety



If not used properly this trimmer can be dangerous! This trimmer can cause serious injury to the operator and others, the warnings and safety instructions must be followed to ensure reasonable safety and efficiency in using this trimmer. The operator is responsible for following the warning and safety instructions in this manual and on the trimmer.

Explanation of Symbols on the Multi Trim Revolution



Warning



The use of eye protection is recommended to protect against objects thrown by the cutting line.



Read the user instructions carefully to make sure you understand all the controls and what they do.



To avoid the possibility of electric shock, do not use in damp or wet conditions.

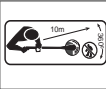

Keep others, including children, pets and bystanders outside the 10 metre hazard zone. Stop the trimmer immediately if you are approached.



Switch off! Remove plug from mains before adjusting, cleaning or if cable is entangled or damaged.

Warning: The cutting line continues to rotate after the machine has been switched off.

General

1. Never allow children or people unfamiliar with these instructions to use the trimmer. Local regulations may restrict the age of the operator.
2. Only use the trimmer in the manner and for the functions described in these instructions.
3. Never operate the trimmer when you are tired, ill or under the influence of alcohol, drugs or medicine.
4. The operator or user is responsible for accidents or hazards occurring to other people or their property.

Electrical

1. The British Standards Institute recommend the use of a Residual Current Device (R.C.D.) with a tripping current of not more than 30mA. Even with a R.C.D. installed 100% safety cannot be guaranteed and safe working practice must be followed at all times. Check your R.C.D. every time you use it.
2. Before use, examine cable for damage, replace it if there are signs of damage or ageing.
3. Do not use the trimmer if the electric cables are damaged or worn.

4. Immediately disconnect from the mains electricity supply if the cable is cut, or the insulation is damaged. Do not touch the electric cable until the electrical supply has been disconnected. Do not repair a cut or damaged cable. Replace it with a new one.
5. Your extension cable must be uncoiled, coiled cables can overheat and reduce the efficiency of your trimmer.
6. Keep the cable clear of the cutting area and obstacles at all times.
7. Do not pull cable around sharp objects.
8. Always switch off at the mains before disconnecting any plug, cable connector or extension cable.
9. Never pull on the cable to disconnect any of the plugs.
10. Switch off, remove plug from mains and examine electric supply cable for damage or ageing **before** winding cable for storage. Do not repair a damaged cable, replace it with a new one. Use only Flymo replacement cable.
11. Always wind cable carefully, avoiding kinking.
12. Use only on AC mains supply voltage shown on the product rating label.
13. Flymo trimmers are double insulated to EN60335. Under no circumstance should an earth be connected to any part of the trimmer.
2. Avoid operating your trimmer in wet grass, where feasible.
3. Take care in wet grass, you may lose your footing.
4. On slopes, be extra careful of your footing and wear non-slip footwear.
5. Do not walk backwards when trimming, you could trip. Walk never run.
6. Keep cutting head below waist level.
7. Switch off before pushing the trimmer over surfaces other than grass.
8. Never operate the trimmer with damaged guards or without guards in place.
9. Never fit metal cutting elements.
10. Keep hands and feet away from the cutting means at all times and especially when switching on the motor.
11. Never pick up or carry a trimmer by the cable.
12. Do not lean over the trimmer guard - objects may be thrown by the cutting line.
13. Remove the plug from the mains :
 - before leaving the trimmer unattended for any period;
 - before clearing a blockage;
 - before checking, cleaning or working on the appliance;
 - if you hit an object. Do not use your trimmer until you are sure that the entire trimmer is in a safe operating condition.;
 - if the trimmer starts to vibrate abnormally. Check immediately. Excessive vibration can cause injury.

Preparation

1. Do not trim barefoot or in open sandals. Always wear suitable clothing, gloves, and stout shoes.
2. Before using the machine and after any impact, check for signs of wear or damage and repair as necessary.
3. Inspect the area to be cut before each use. Remove all objects such as stones, broken glass, nails, wire, string etc, which can be thrown or become entangled in the trimmer head.
4. Check that the cutting head, spool and cap are fitted correctly.

Use

AVOID ACCIDENTAL STARTING. KEEP YOUR HANDS AND FINGERS AWAY FROM THE SWITCH LEVERS.

1. Use the trimmer only in daylight or good artificial light.

Maintenance and storage

1. Keep all nuts, bolts and screws tight to be sure the trimmer is in safe working condition.
2. Replace worn or damaged parts for safety.
3. Only use the replacement cutting line specified for this product.
4. Only use replacement parts and accessories recommended by Electrolux Outdoor Products.
5. To avoid the risk of injury keep fingers and hands clear of the line cutter on the leading edge of the guard.
6. Inspect and maintain the trimmer regularly. Any repairs must be carried out by an authorised repairer.

Cables

IMPORTANT

Use only 1.00mm² size cable up to 30 metres length maximum.

Maximum rating:

- 1.00mm² size cable, 10 amps 250 volts AC.

THE MULTI TRIM REVOLUTION IS SUPPLIED WITH AN ELECTRIC MAINS CABLE WIRED DIRECTLY INTO THE PRODUCT.

1. Flymo Mains Cables and Extension Cables are available from your local Electrolux Outdoor Products Approved Service Centre.
2. Do not wire an extension cable directly to your product yourself. Please contact your local Electrolux Outdoor Products Approved Service Centre for further information on the connectors and kits available.
3. Only use extension cables specifically designed for outdoor use.

CONNECTORS

Flymo connectors are suitable for use with 2 core cable only. Under no circumstances should these connectors be used for earthed products.

All Flymo connectors and cables are of splashproof construction. They are not waterproof and must not be left outside permanently nor should they be submerged or immersed in water. Do not let cable lay or trail through pools of water or splashed with water from hose pipes.

MAINS PLUG REPLACEMENT

- If the plug supplied is cut off it should be destroyed. There is an electric shock hazard if a cut off plug is inserted into a 13 amp socket.

1. **No earth required.** Flymo products are double insulated to EN60335 and under no circumstances should an earth be connected to any part of the product.

2. **Ensure the mains voltage suits your product.**

3. **IMPORTANT!**

The wires in the mains lead are coloured in accordance with the following code:

BLUE	-	NEUTRAL
BROWN	-	LIVE

The wire which is coloured BLUE must be connected to the Terminal which is marked with the letter 'N' or coloured BLACK. The wire which is coloured BROWN must be connected to the Terminal which is marked with the letter 'L' or coloured RED.

4. It is important that the outer sheath is clamped correctly into the 3-pin plug.
5. If in doubt consult your local Service Repairer or qualified electrician before the machine is used.
6. **A 5 Amp fuse must be fitted to the Mains Plug.**
7. The normal plug fuse and household fuse only protect the electrical equipment and are not a safeguard against electrocution.

If your product is hard wired i.e. non-detachable mains electric cable, a conversion kit and extension cable is available from all Electrolux Outdoor Products Approved Service Centres which can be found in your local Yellow Pages.

Assembly Instructions

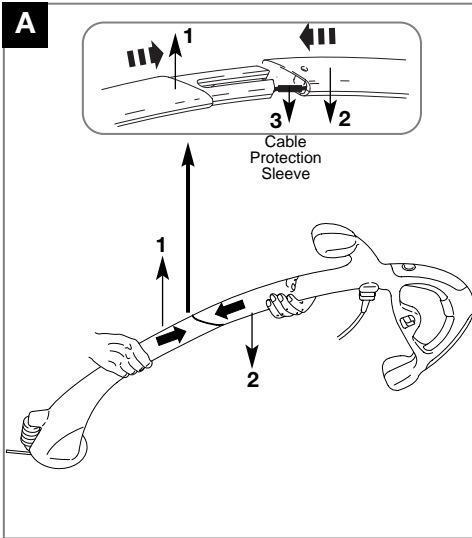

Shaft Assembly (A)

1. Locate the lower shaft (**A1**) into the upper shaft (**A2**).
- Note: the black internal cable and cable protection sleeve (A3) are self-locating**
2. Grasp firmly and hold steady the lower shaft. Locate the upper shaft and snap together firmly.
- **The unit is correctly assembled when the gap between the upper and lower shaft has been closed.**

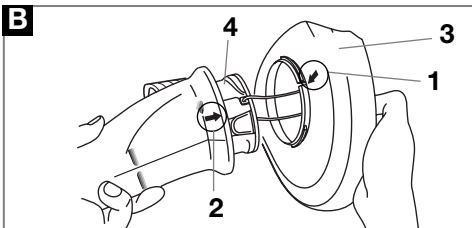

Safety Guard Assembly (B) & (C)

1. Align the arrow on the top of the safety guard (**B1**) with the arrow on the side of the trimmer (**B2**).
 2. Locate the safety guard (**B3**) over the cutting head (**B4**). Ensure the nylon lines are fed through the hole in the safety guard as illustrated in **fig B**.
 3. Push into location and turn safety guard in the direction illustrated in **Fig C**, until a click is heard and the safety guard is securely locked in position.
- **ENSURE THE SAFETY GUARD IS SECURELY IN PLACE BY ATTEMPTING TO TWIST GUARD.**

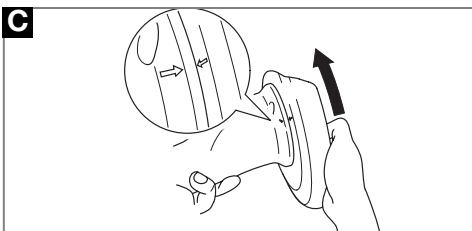

Cable Restraint

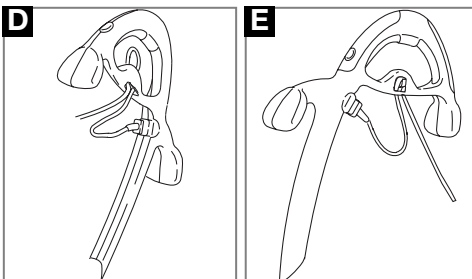

Cable Restraint (D) & (E)

1. Form loop in mains cable and push the loop through the slot as illustrated in picture (**D**).
2. To secure, position loop over the hook and pull the cable back through the slot as illustrated in picture (**E**).

Double Auto Feed System

How the automatic line feed works (F)

- When initially switching on the trimmer, a small length of line is fed out.
- A 'clattering' noise will be heard when the two nylon lines hit the line cutter. **DO NOT BE ALARMED this is quite normal.** After approximately 5 seconds the line will be cut to the correct length and the noise will reduce as the motor reaches full speed.
 - **Make sure the motor is up to full speed before trimming or edging.**
- If the noise of the nylon line being cut cannot be heard, more line will need to be fed out.
- To feed more line, it is first necessary to allow the motor to stop completely, then re-start, allowing the motor to reach full speed.
- Repeat step 4. until you hear the lines hitting against the cutter. (Do not repeat this procedure more than 6 times)
- If problems are experienced with the automatic line feed refer to Fault Finding Chart.

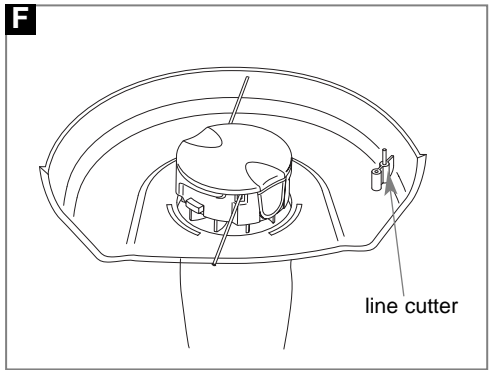

How to trim and edge

- **WARNING**
- **The use of eye protection is recommended. Do not lean over the trimmer whilst trimming or edging, objects may be thrown by the cutting line.**
- **Do not allow cutting head to rest on the ground. Do not overload your trimmer. Overloading can be avoided by making sure the motor speed does not drop unduly. Disconnect from the mains electricity supply before attempting any maintenance or adjustment.**
- **BEFORE USE**
- **Make sure that both lines are fed out.**
- **Make sure motor is up to full speed before trimming or edging.**

How to trim

- **The switchbox is provided with a lock-off button (G1) to prevent accidental starting.**
- Hold as illustrated in **Fig H**.
 - To start, press the lock-off button down (**G1**), whilst pressing the lock-off button squeeze the switch lever (**G2**).
 - When the trimmer starts release the lock-off button (**G1**).
 - Cut with nylon line at an angle using the tip **See Fig H**.
 - Swing trimmer in and out of the cutting area taking small cuts. **See Fig J**.
 - Line is fed out automatically every time the trimmer head stops rotating and returns to operating speed.
 - Extra line can be fed out manually as described on **page 6**.
 - To stop your trimmer release the switch lever (**G2**)

How to edge

- Hold as illustrated in **Fig L**.
- To start, press the lock-off button down (**K1**), whilst pressing the lock-off button squeeze the switch lever (**K2**).
- When the trimmer starts release the lock-off button (**K1**).
- Rest edger on roller for extra stability and line up with the edge of the lawn, **see fig M**. Edge in direction indicated in **fig L** so that debris is thrown away from you.
- To stop your trimmer release the switch lever (**K2**).
- To return to trimming mode, turn trimmer over.
- **Ensure the electric cable is not snagged or pulled around sharp objects.**

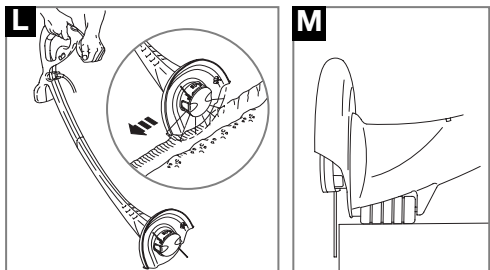
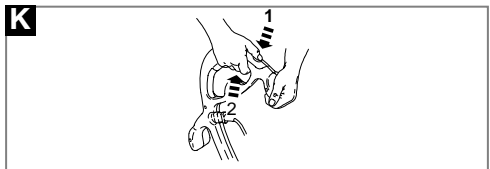
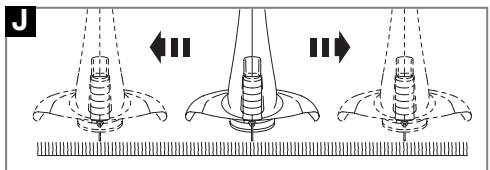
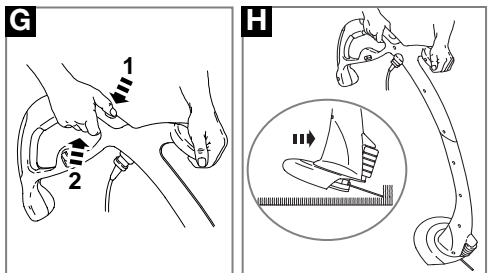

Fault Finding Chart

WARNING Disconnect from the mains electricity supply before attempting any maintenance or adjustment.

FAULT	CHECK	ACTION
LINE NOT FEEDING OR LINE TOO SHORT OR TRIMMER VIBRATES	Is the automatic line feed working?	No Manually feed out line. SEE "MANUAL LINE FEED"
	Is the line fed out and visible?	No Remove cap and spool, free line and re-fit spool and cap. SEE "SPOOL CAP AND NYLON LINE"
	Is the manual line feed working?	No The line may be jammed on the spool. Rewind line to remove crossed loops. Check that line is in correct section of spool.
CONTINUOUS CLATTERING NOISE	Has the motor reached full speed before use?	No Allow the motor to reach full speed before use
	Has too much line been fed out?	Yes SEE "MANUAL LINE FEED"
	Is the line cutter missing from the safety guard?	Yes Contact your local approved Service Centre or Electrolux Outdoor Products Customer Service.
LINE SNAPS CONTINUOUSLY	Are you using the trimmer correctly?	? Only use tip of nylon line to trim. SEE "How to trim and edge"
	Is the line jamming on the spool?	Yes Rewind the line on the spool, if symptoms still persist, change spool and line.
IF NONE OF THE ABOVE OR IF FAULT PERSISTS	Contact Electrolux Outdoor Products Customer Service Telephone : 01325 300303	

Manual line feed

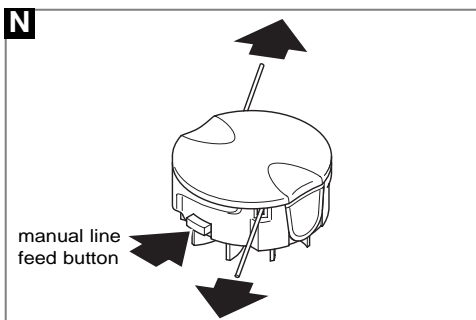

To manually feed the nylon line (N)

1. If required line can be fed out manually.
2. To operate, press and release manual line feed button, whilst gently pulling on one of the lines until the line reaches the line cutter.
3. When the required amount of line is fed out, gently pull on the second line (there is no need to press the manual line feed button again).
4. If the line extends past the line cutter, too much line has been fed out.
5. If too much line is fed out, remove the spool cap and click spool anti-clockwise until the line is at the desired length.

Spool cap and nylon line

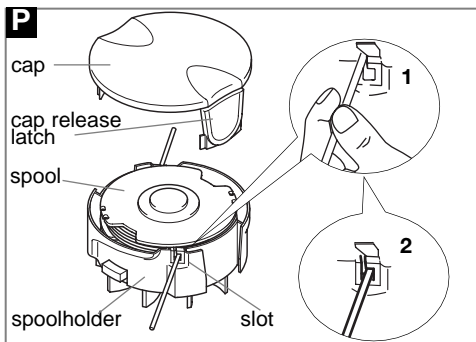

To remove spool cap

1. Press and hold in the two cap release latches. **(P)**.
2. **Pull** cap away from the spoolholder. **(P)**.

When refitting the spool cap

1. Keep all areas of the cap and spoolholder clean. Failure to do so may prevent the cap being securely located in the spoolholder.
2. Replace the cap, **pressing firmly DOWN** towards the spoolholder to ensure cap is fully located.
3. Check that the cap is correctly fitted by trying to remove it without depressing the two latches.

Spool cap and nylon line cont'

To replace nylon line.

For your convenience it is recommended you buy spool and line complete. Nylon line only is also available. Both are available from Electrolux Outdoor Products stockists.

- If you have spool and line complete, follow steps 5 to 11.
- If you have nylon line only, follow the full procedure below.

IMPORTANT

- Always wind the line onto the upper section of the spool first.**
- **Remember! Your Flymo Trimmer is designed to use only nylon line with a maximum diameter of 1.5mm. Use only genuine Flymo nylon line.**
1. Take approximately 5 metres of line. Insert 15mm of line into one of the holes in the upper section of the spool (Q) and wind line in the direction of the arrows on the top of the spool.
 2. Leave approximately 100mm of line unwound and place into cleat as illustrated in figure R.
 3. Repeat on lower section of spool.
 4. Care should be taken to ensure that the line is neatly coiled on the spool. Failure to do so will impair the efficiency of the automatic line feed.
 5. Remove the cap.
 6. Remove the old spool.
 7. Place spool into spoolholder.
 8. Release one line from cleat.
 9. Secure line into slot (P).
 10. Repeat for second line.
- **Ensure spool is fully located by gently rotating it during fitment, whilst keeping the spoolholder steady.**
11. Refit the cap.

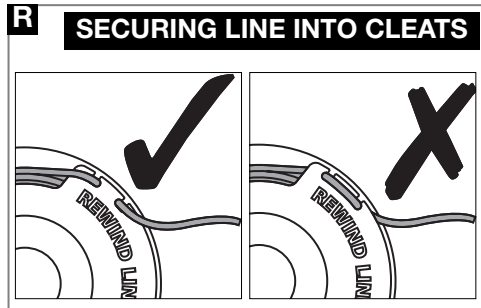
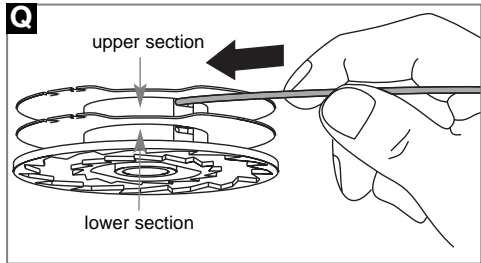

Maintenance

WARNING

Disconnect from the mains electricity supply, before attempting any maintenance or adjustment. Cutting head continues to rotate after the trimmer has been switched off. Keep fingers and hands clear of the line cutter on leading edge of guard.

Caring for your Multi-Trim Revolution

After you have finished using your Flymo Multi-Trim Revolution follow the procedure below:

1. Disconnect from the mains electricity supply.
 2. Never clean your trimmer with water, cleaning fluids, or solvents, just remove debris with a suitable tool, a soft brush or dry cloth.
 4. Using a soft brush, clean around the inside of the safety guard, the cutting head (Fig S) and the motor housing air vents.(Fig T)
 5. Inspect the trimmer carefully, especially the parts of the cutting head.
 6. If your trimmer is damaged in any way contact your local Electrolux Outdoor Products approved service centre.
- **Never use a damaged trimmer.**
7. Wind cable carefully to avoid kinking.
 8. Store in a cool, dry place and out of reach of children.

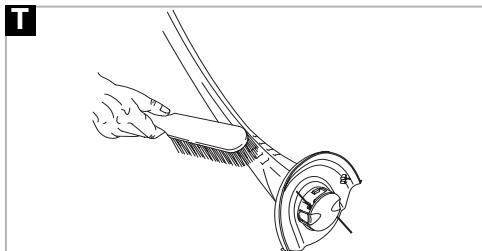
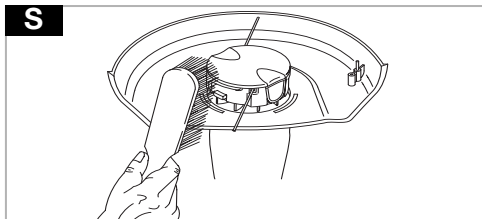

Environmental Information

Electrolux Outdoor Products are manufactured under an Environmental Management System (ISO 14001) using, where practical, components manufactured in the most environmentally responsible manner, according to company procedures, and with the potential for recycling at the end of the products' life.

- Packaging is recyclable and plastic components have been labelled (where practical) for categorised recycling.
- Awareness of the environment must be considered when disposing of 'end-of-life' product.
- If necessary, contact your local authority for disposal information.

Service Recommendations

1. We strongly recommend that your product is serviced at least every twelve months, more often in a professional application.
2. Always use genuine Flymo Spare Parts.
3. Prepacked spares are available from most Electrolux Outdoor Products stockists.
4. Your product is uniquely identified by a silver and black product rating label.
5. If you have a problem with your machine contact your local Approved Service Centre ensuring you have full details of your product as described on the product rating label.
6. **Should it be necessary for work to be carried out by your**

Service Centre, it is important to take your complete machine including cable and any extension cables used.

A network of specialist dealers can be found in your local Yellow Pages. To obtain service on your Flymo product simply telephone or visit your local Service Centre. Should you require service under the terms of our guarantee the Service Centre will require proof of purchase.

All of the centres listed stock genuine Flymo Spare Parts.
NOTE: Our Service Repairers act on their own behalf and are not empowered to commit or legally bind Electrolux Outdoor Products in any manner whatsoever.

Guarantee & Guarantee Policy

If any part is found to be defective due to faulty manufacture within the guarantee period, Electrolux Outdoor Products, through its Authorised Service Repairers will effect the repair or replacement to the customer free of charge providing:

- (a) The fault is reported directly to the Authorised Repairer.
 - (b) Proof of purchase is provided.
 - (c) The fault is not caused by misuse, neglect or faulty adjustment by the user.
 - (d) The failure has not occurred through fair wear and tear.
 - (e) The machine has not been serviced or repaired, taken apart or tampered with by any person not authorised by Electrolux Outdoor Products.
 - (f) The machine has not been used for hire.
 - (g) The machine is owned by the original purchaser.
 - (h) The machine has not been used outside of the country for which it was specified.
 - (i) The machine has not been used commercially.
- * This guarantee is additional to, and in no way diminishes the customers statutory rights.

Failures due to the following are not covered, therefore it is important that you read the instructions contained in this Operator's Manual and understand how to operate and maintain your machine:

Failures not covered by guarantee

- * Replacing Nylon Line
- * Failures as a result of not reporting an initial fault.
- * Failures as a result of sudden impact.
- * Failures as a result of not using the product in accordance with the instructions and recommendations contained in this Operator's Manual.
- * Machines used for hire are not covered by this guarantee.
- * The following items listed are considered as wearing parts and their life is dependent on regular maintenance and are, therefore not normally subject to a valid warranty claim: Nylon Line, Electric Mains Cable

Caution!

Electrolux Outdoor Products does not accept liability under the warranty for defects caused in whole or part, directly or indirectly by the fitting of replacement parts or additional parts that are not either manufactured or approved by Electrolux Outdoor Products, or by the machine having been modified in any way.

EC Declaration of Conformity

I, the undersigned M. Bowden of Electrolux Outdoor Products, Aycliffe Industrial Park, **NEWTON AYCLIFFE**, Co. Durham. DL5 6UP. Certify that the product:-
 Category.....**Electric Lawn Trimmer**
 Make.....**Electrolux Outdoor Products**
 Conforms to the specifications of Directive 2000/14/EEC

I, the undersigned M. Bowden of Electrolux Outdoor Products, Aycliffe Industrial Park, **NEWTON AYCLIFFE**, Co. Durham. DL5 6UP. Certify that a sample of the above product has been tested using directive 81/1051/EEC as a guide. The maximum A-weighted sound pressure level recorded at operator position under free field semi anechoic chamber conditions was :-

I, the undersigned M. Bowden of Electrolux Outdoor Products, Aycliffe Industrial Park, **NEWTON AYCLIFFE**, Co. Durham. DL5 6UP. Certify that a sample of the above product has been tested using ISO 5349 as a guide. The maximum weighted root mean square value of vibration recorded at operator's hand position was:-

Type of Cutting Device..... Cutting Line Identification of Series..... See Product Rating Label Conformity Assessment Procedure..... ANNEX VI Notified Body..... L.T.S., Cleeve Road, Leatherhead, Surrey. KT22 7SB England Other Directives:-..... 98/37/EEC, 89/336/EEC, 73/23/EEC & applicable standards:-, EN786:1996, EN786A2:1996, IEC335-1:1991, IEC60335-2-91:1997, EN60555-2:1987, EN60555-3:1987, EN55014:1993, EN55014:1995	Type..... Width of Cut..... Speed of Rotation of Cutting Device..... Guaranteed Sound Power Level..... Measured Sound Power Level..... Level..... Value..... Weight.....	REV 200/230 23cm 9,500 rpm 94 dB(A) 93 dB(A) 83.3 dB(A) 3.2 m/s² 2.2 kg	REV 250 25cm 9,000 rpm 94 dB(A) 93 dB(A) 80.2 dB(A) 5.3 m/s² 2.3 kg
---	---	---	---

Newton Aycliffe, 05/07/2002
 M. Bowden,
 Research & Development Director

Electrolux Outdoor Products
 Aycliffe Industrial Park
 NEWTON AYCLIFFE
 Co. Durham DL5 6UP
 ENGLAND

Telephone - (00) 44 1325 300303 Fax - (00) 44 1325 310339
UK Customer Helpline - 01325 300303 Fax - 01325 310339

Our policy of continuous improvement means that the specification of products may be altered from time to time without prior notice. Electrolux Outdoor Products manufacture products for a number of well known brands under various registered patents, designs and trademarks in several countries.

© Electrolux Outdoor Products Ltd. Registered Office, Electrolux Works, Oakley Road, Luton LU4 9QQ
 Registered number 974979 England



The Electrolux Group. The world's No.1 choice.

The Electrolux Group is the world's largest producer of powered appliances for kitchen, cleaning and outdoor use. More than 55 million Electrolux Group products (such as refrigerators, cookers, washing machines, vacuum cleaners, chain saws and lawn mowers) are sold each year to a value of approx. USD 14 billion in more than 150 countries around the world.

5119315-03



Free Manuals Download Website

<http://myh66.com>

<http://usermanuals.us>

<http://www.somanuals.com>

<http://www.4manuals.cc>

<http://www.manual-lib.com>

<http://www.404manual.com>

<http://www.luxmanual.com>

<http://aubethermostatmanual.com>

Golf course search by state

<http://golfingnear.com>

Email search by domain

<http://emailbydomain.com>

Auto manuals search

<http://auto.somanuals.com>

TV manuals search

<http://tv.somanuals.com>