

# Flymo<sup>®</sup>

## *Mini-Trim*

INSTRUCTION MANUAL

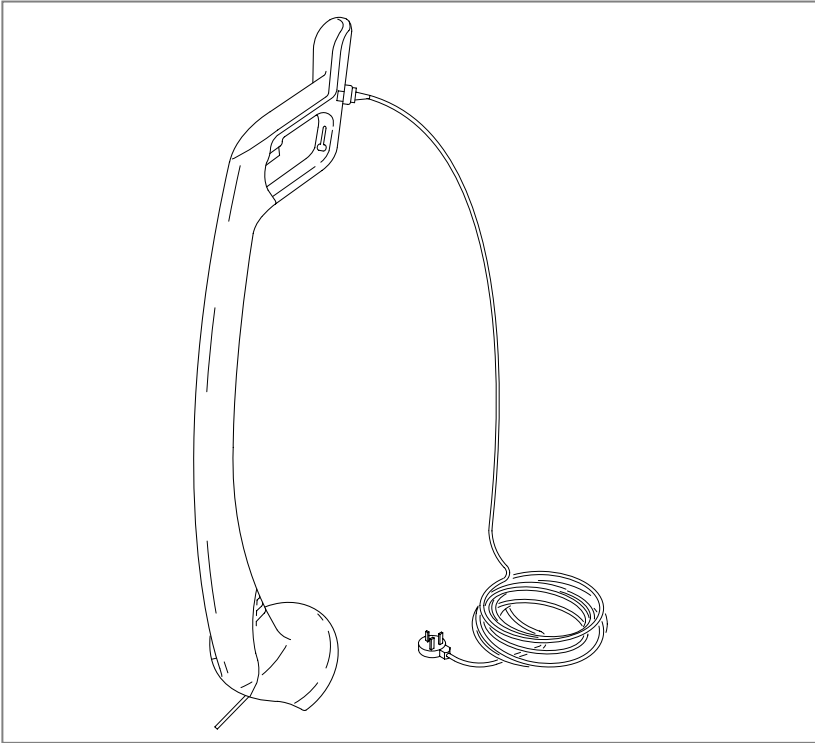

**IMPORTANT INFORMATION**

Read before use

& retain for future reference



WARNING

## Carton Contents

A

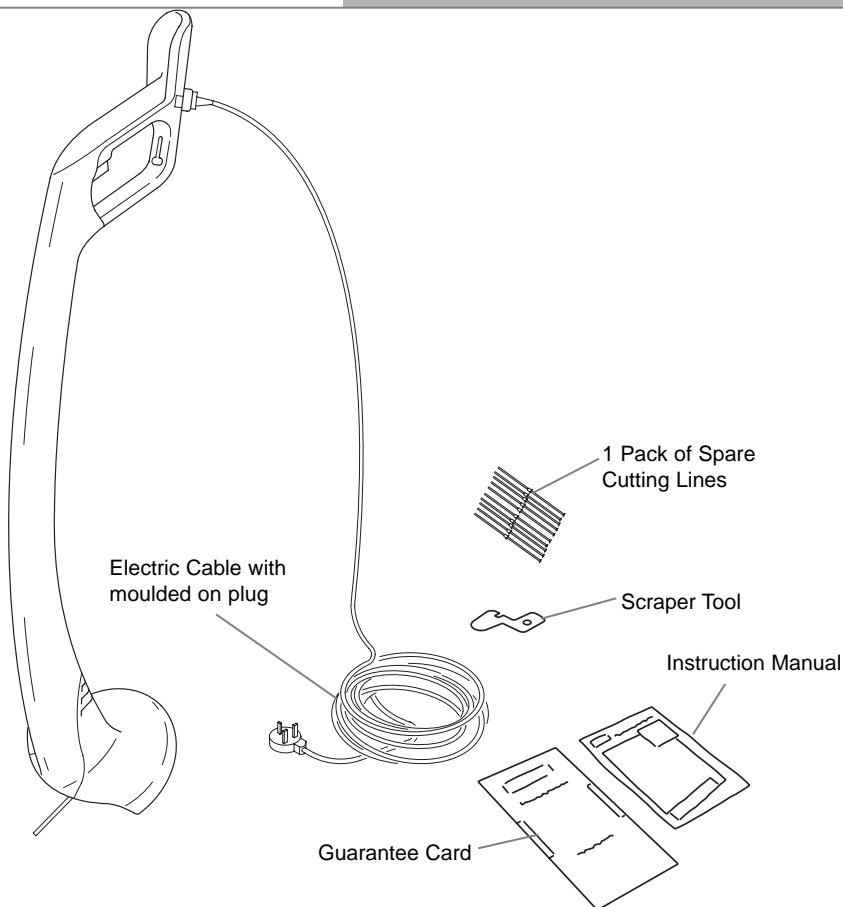

### LIST OF INSTRUCTION MANUAL CONTENTS

CONTENTS	(1)
SAFETY	(2-4)
USE	(5-8)
MAINTENANCE	(9-10)
GUARANTEE	(11)
CERTIFICATE OF CONFORMITY & INSIDE BACK COVER	(12)

### IMPORTANT !

Please check the contents of the carton are correct **BEFORE** assembling your new Flymo product.

### IF ANY PARTS ARE MISSING CONTACT:-

Flymo/Partner Customer Service Department  
 direct Telephone : 01325 300303  
 Fax : 01325 318193



If not used properly this trimmer can be dangerous! This trimmer can cause serious injury to the operator and others, the warnings and safety instructions must be followed to ensure reasonable safety and efficiency in using this trimmer. The operator is responsible for following the warning and safety instructions in this manual and on the trimmer.

### Explanation of Symbols on the Mini-Trim



Warning

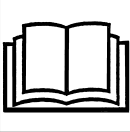

Read the user instructions carefully to make sure you understand all the controls and what they do.

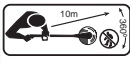

Keep others, including children, pets and bystanders outside the 10 metre hazard zone. Stop the trimmer immediately if you are approached.



The use of eye protection is recommended to protect against objects thrown by the cutting line.



To avoid the possibility of electric shock, do not use in damp or wet conditions.



Switch off! Remove plug from mains before adjusting, cleaning or if cable is entangled or damaged.

### Warning

The cutting line continues to rotate after the machine has been switched off.

### General

1. Never allow children or people unfamiliar with these instructions to use the trimmer. Local regulations may restrict the age of the operator.
2. Only use the trimmer in the manner and for the functions described in these instructions.
3. Never operate the trimmer when you are tired, ill or under the influence of alcohol, drugs or medicine.
4. The operator or user is responsible for accidents or hazards occurring to other people or their property.

### Electrical

1. The British Standards Institute recommend the use of a Residual Current Circuit Breaker (R.C.C.B.) with a tripping current of not more than 30mA. Even with a R.C.C.B. installed 100% safety cannot be guaranteed and safe working practice must be followed at all times. Check your R.C.C.B. every time you use it.
2. Before use, examine cable for damage, replace it if there are signs of damage or ageing.
3. Do not use the trimmer if the electric cables are damaged or worn.
4. Immediately disconnect from the mains electricity supply if the cable is cut, or the insulation is damaged. Do not touch the electric cable until the electrical supply has been disconnected. Do not repair a cut or damaged cable. Replace it with a new one.
5. Your extension cable must be uncoiled, coiled cables can overheat and reduce the efficiency of your trimmer.
6. Keep the cable clear of the cutting area and obstacles at all times.

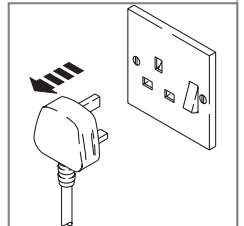

7. Do not pull cable around sharp objects.
8. Always switch off at the mains before disconnecting any plug, cable connector or extension cable.
9. Switch off, remove plug from mains and examine electric supply cable for damage or ageing **before** winding cable for storage. Do not repair a damaged cable, replace it with a new one. Use only Flymo replacement cable.
10. Always wind cable carefully, avoiding kinking.
11. Use only on AC mains supply voltage shown on the product rating label.
12. Flymo trimmers are double insulated to BS3456. Under no circumstance should an earth be connected to any part of the trimmer.
13. Never carry the trimmer by the cable.
14. Never pull on the cable to disconnect any of the plugs.
10. Avoid possible injuries to feet and hands from rotating cutting line. Always start the trimmer carefully with feet and hands well away from the cutting head.
11. Never pick up or carry a trimmer by the cable.
12. Do not lean over the trimmer guard - objects may be thrown by the cutting line.
13. Remove the plug from the mains :

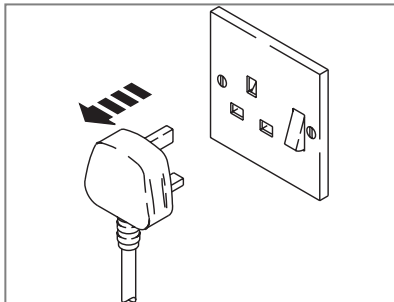

### Preparation

1. Do not trim barefoot or in open sandals. Always wear suitable clothing, gloves, and stout shoes.
2. Inspect the trimmer before each use, especially the parts of the cutting head.
3. Inspect the area to be cut before each use. Remove all objects such as stones, broken glass, nails, wire, string etc, which can be thrown or become entangled in the trimmer head.
4. Check that the cutting head and cutting line are fitted correctly.

### Use

#### **AVOID ACCIDENTAL STARTING. KEEP YOUR HANDS AND FINGERS AWAY FROM THE SWITCH LEVER.**

1. Use the trimmer only in daylight or good artificial light.
2. Avoid operating your trimmer in wet grass, where feasible.
3. Take care in wet grass, you may lose your footing.
4. On slopes, be extra careful of your footing and wear non-slip footwear.
5. Do not walk backwards when trimming, you could trip. Walk never run.
6. Keep cutting head below waist level.
7. Switch off before pushing the trimmer over surfaces other than grass.
8. Never operate the trimmer with damaged guards or without guards in place.
9. Never fit metal cutting elements.

- before leaving the trimmer unattended for any period;
- before clearing a blockage;
- before checking, cleaning or working on the appliance;
- if you hit an object. Do not use your trimmer until you are sure that the entire trimmer is in a safe operating condition.;
- if the trimmer starts to vibrate abnormally. Check immediately.

### Maintenance and storage

1. Keep all nuts, bolts and screws tight to be sure the trimmer is in safe working condition.
2. Replace worn or damaged parts for safety.
3. Only use the replacement cutting line specified for this product.
4. Only use replacement parts and accessories recommended by Flymo/Partner.
5. Inspect and maintain the trimmer regularly. Any repairs must be carried out by an authorised repairer.

## CABLES

### IMPORTANT

- Use only 1.00mm<sup>2</sup> size cable up to 30 metres length maximum for trimmers and 60 metres length maximum for lawnmowers.

### Maximum rating:

1.00mm<sup>2</sup> size cable, 10 amps 250 volts AC.

- Flymo products are supplied with either an electric mains cable fitted with a female connector or with an electric mains cable wired directly into the product.

**THE MINI-TRIM IS SUPPLIED WITH AN ELECTRIC MAINS CABLE WIRED DIRECTLY INTO THE PRODUCT.**

- Flymo Mains Cables and Extension Cables are available from your local Flymo/Partner Approved Service Centre.
- Do not wire an extension cable directly to your product yourself. Please contact your local Flymo/Partner Approved Service Centre for further information on the connectors and kits available.
- Only use extension cables specifically designed for outdoor use.

## CONNECTORS

### IMPORTANT

- Flymo connectors are suitable for use with 2 core cable only. Under no circumstances should these connectors be used for earthed products.
- All Flymo connectors and cables are of splashproof construction. They are not waterproof and must not be left outside permanently nor should they be submerged or immersed in water. Do not let cable lay or trail through pools of water or splashed with water from hose pipes.

## MAINS PLUG REPLACEMENT

### IMPORTANT

- If the plug supplied is cut off it should be destroyed. There is an electric shock hazard if a cut off plug is inserted into a 13 amp socket.
- No earth required.** Flymo products are double insulated to BS3456 and under no circumstances should an earth be connected to any part of the product.
  - Ensure the mains voltage suits your product.**
  - IMPORTANT!**

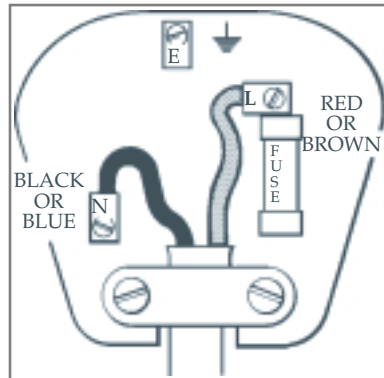

The wires in the mains lead are coloured in accordance with the following code:

BLUE - NEUTRAL  
BROWN - LIVE

The wire which is coloured BLUE must be connected to the Terminal which is marked with the letter 'N' or coloured BLACK. The wire which is coloured BROWN must be connected to the Terminal which is marked with the letter 'L' or coloured RED.

- It is important that the outer sheath is clamped correctly into the 3-pin plug.
- If in doubt consult your local Service Repairer or qualified electrician before the machine is used.
- A 5 Amp fuse must be fitted to the Mains Plug.**
- The normal plug fuse and household fuse only protect the electrical equipment and are not a safeguard against electrocution.

**For Further information on Mains Cables, Extension Cables, Cable Connectors and kits contact Flymo/Partner Customer Service direct:-**

Telephone : 01325 300303  
Fax : 01325 318193

## Product Rating Label

Your product is uniquely identified by a silver and black product rating label. To ensure you have full product information when obtaining spares or advice from one of our approved service centres, or if you need to contact our customer service department, you should make a note in the space provided of the information shown in fig.B. It will also be useful to make a note of the date and place of purchase before you return your guarantee card.

**B**

Product Number . . . . .

Model Number . . . . .

Serial Number . . . . .

Date of Purchase . . . . .

Place of Purchase . . . . .

**•PLEASE KEEP PROOF OF PURCHASE•**

## Starting and Stopping

- WARNING**

**Cutting head continues to rotate after the trimmer has been switched off.**

**To start your trimmer**

Squeeze the switch lever **(C)**.

**To stop your trimmer**

Release the switch lever **(C)**.

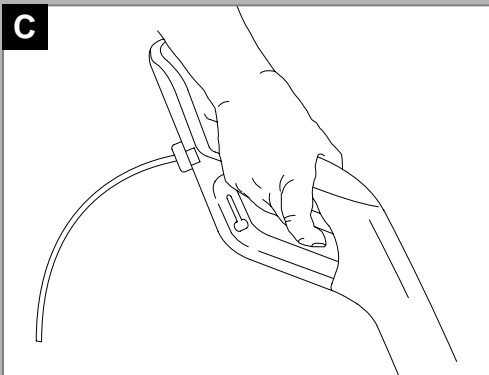
**C**

**USE**

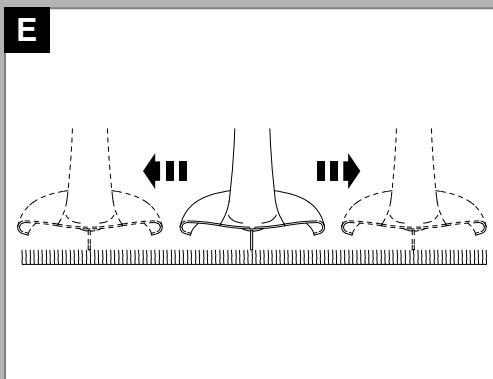
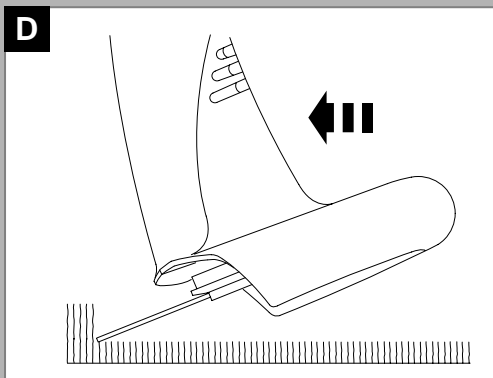
## How to trim



- **WARNING**

The use of eye protection is recommended. Do not lean over the trimmer guard whilst trimming, objects may be thrown by the cutting line. Do not allow cutting head to rest on the ground. Do not overload your trimmer. Overloading can be avoided by making sure the motor speed does not drop unduly.

Disconnect from the mains electricity supply before attempting any maintenance or adjustment.

1. Cut with cutting line at an angle using the tip.
2. Swing trimmer in and out of the cutting area taking small cuts.

## Removing the Cutting Line

- WARNING**

Disconnect from the mains electricity supply, before attempting any maintenance or adjustment. Cutting head continues to rotate after the trimmer has been switched off.

### Removing broken or worn cutting line.

For best results, replace the cutting line when worn to no less than 20 mm from the edge of the cutting head. (Fig F)

Using the pip in the centre of the line, pull the line upwards and out of the cutting head. (Fig G)

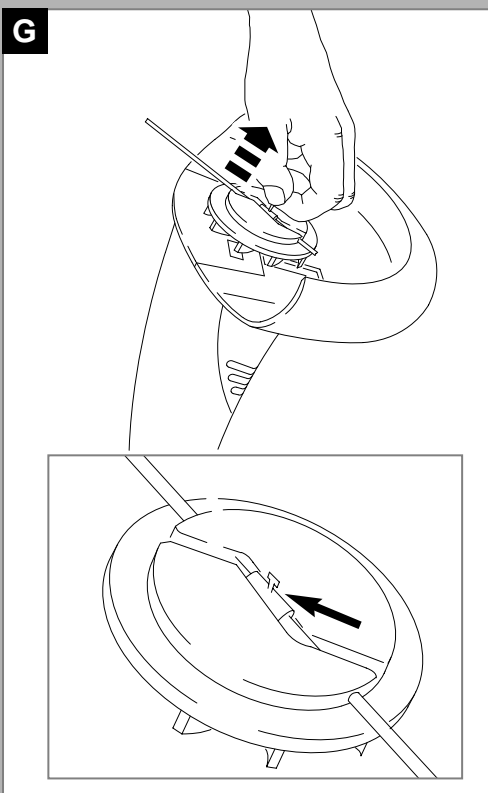
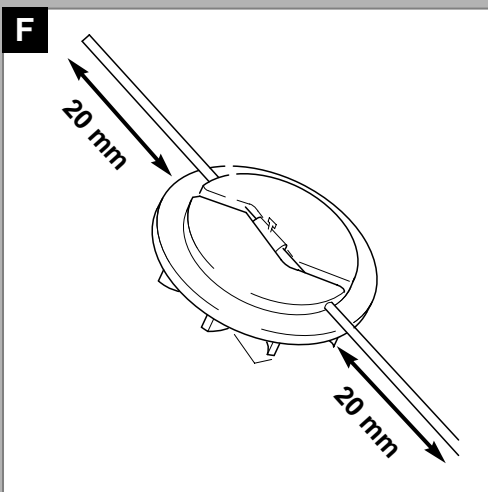



## Replacing the Cutting Line

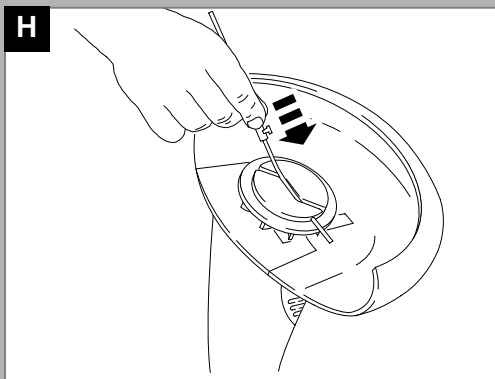

Insert one end of the cutting line into the centre of the cutting head and push until the end of the line comes out at one end of the slot. **(Fig. H)**

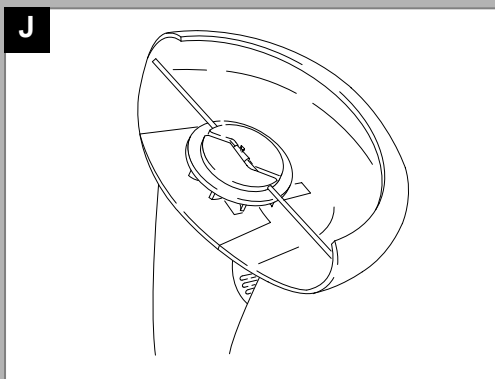

Secure the centre piece of the cutting line into the centre of the cutting head and guide the other side of the cutting line along the slot until it is securely located as illustrated in **Fig. J**.

### Storing the spare cutting lines.

Cutting lines can be stored in the storage facility provided in the back of the trimmer stem. To store your line, insert one end of the line into the top slot and one end of the line into the bottom slot. Then take the centre pip and insert it into the hole in the middle slot and slide over to the left as illustrated in **Fig. K**.

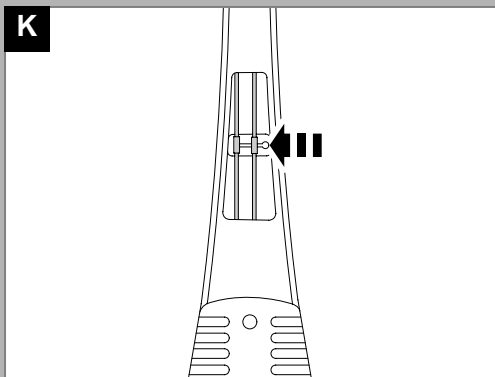

## Caring for your Trimmer

- WARNING**

**Disconnect from the mains electricity supply, before attempting any maintenance or adjustment. Cutting head continues to rotate after the trimmer has been switched off.**

After you have finished using your Flymo Trimmer follow the procedure below:

1. Disconnect from the mains electricity supply.
  2. Never clean your trimmer with water, cleaning fluids, or solvents, just remove debris with a suitable tool, a soft brush or dry cloth.
  3. Using the scraper provided, clean around the inside of the cutting head housing to remove any grass and debris. **(Fig L)**
  4. Using a soft brush, clean around the inside of the cutting head housing **(Fig M)**, the cutting head **(Fig N)** and the motor housing air vents. **(Fig P)**
  5. Inspect the trimmer carefully, especially the parts of the cutting head.
  6. If your trimmer is damaged in any way contact your local Flymo/Partner approved service centre.
- **Never use a damaged trimmer.**
7. Wind cable carefully to avoid kinking.
  8. Store in a cool, dry place and out of reach of children.

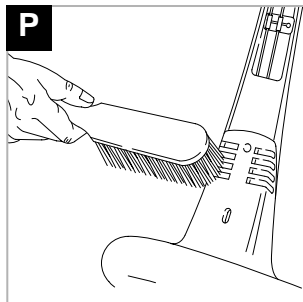
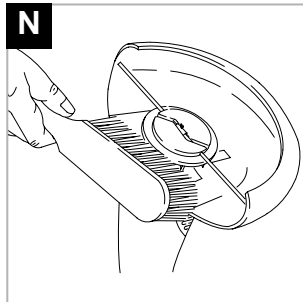
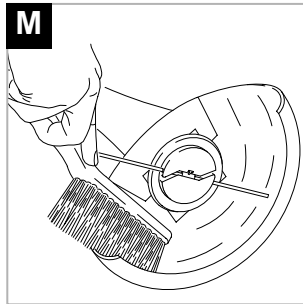
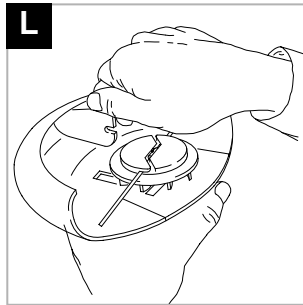

## Fault Finding Hints & Service Recommendations

### Fault Finding Hints

#### Fails To Operate

1. Is the power turned on?
2. Check the fuse in the plug, if blown, replace.
3. Fuse continues to blow?

**Immediately disconnect from the mains electricity supply and consult your local approved Service Centre**

#### Poor Trimming.

1. Check length of line. If broken or worn to less than 20mm from the edge of the cutting head, replace line. See Removing & Replacing cutting line, page 7 & 8.
2. Check if cutting head is rotating freely. Remove any debris. See Caring for your Trimmer page 9.

### Service Recommendations

1. Always use genuine Flymo Spare Parts.
2. Prepacked spares are available from most Flymo/Partner stockists.
3. If you have a problem with your machine contact your local Approved Service Centre ensuring you have full details of your product as described on the product rating label.
4. **Should it be necessary for work to be carried out by your Service Centre, it is important to take your complete machine with you.**
5. In the event of further difficulty please contact:-  
**Flymo/Partner, Customer Service**  
**Flymo/Partner**  
**a division of Electrolux Outdoor Products**  
 Preston Road  
 Aycliffe Industrial Estate,  
 NEWTON AYCLIFFE,  
 Co. Durham.  
 DL5 6UP  
**Telephone: (01325) 300303**  
**Fax : (01325) 318193**

A network of specialist dealers can be found in your local Yellow Pages.

To obtain service on your Flymo product simply telephone or visit your local Service Centre.

Should you require service under the terms of our guarantee the Service Centre will require proof of purchase.

**All of the centres stock genuine Flymo Spare Parts.**

#### NOTE:

**Our Service Repairers act on their own behalf and are not empowered to commit or legally bind Flymo/Partner in any manner whatsoever.**

## Guarantee & Guarantee Policy

### Guarantee & Guarantee Policy

If any part is found to be defective due to faulty manufacture within one year of original purchase, Flymo/Partner, through its Authorised Service Repairers will effect the repair or replacement to the customer free of charge providing:

- (a) The fault is reported directly to the Authorised Repairer.
  - (b) Proof of purchase is provided.
  - (c) The fault is not caused by misuse, neglect or faulty adjustment by the user.
  - (d) The failure has not occurred through fair wear and tear.
  - (e) The machine has not been serviced or repaired, taken apart or tampered with by any person not authorised by Flymo/Partner.
  - (f) The machine has not been used for hire.
  - (g) The machine is owned by the original purchaser.
  - (h) The machine has not been used outside of the country for which it was specified.
  - (i) The machine has not been used commercially.
- \* This guarantee is additional to, and in no way diminishes the customers statutory rights.

Failures due to the following are not covered, therefore it is important that you read the instructions contained in this Operator's Manual and understand how to operate and maintain your machine:

### Failures not covered by guarantee

- \* Replacing Cutting Line.
- \* Failures as a result of not reporting an initial fault.
- \* Failures as a result of sudden impact.
- \* Failures as a result of not using the product in accordance with the instructions and recommendations contained in this Operator's Manual.
- \* Machines used for hire are not covered by this guarantee.
- \* The following items listed are considered as wearing parts and their life is dependent on regular maintenance and are, therefore not normally subject to a valid warranty claim: Cutting Line, Electric Mains cable.

### \* **Caution!**

Flymo/Partner does not accept liability under the warranty for defects caused in whole or part, directly or indirectly by the fitting of replacement parts or additional parts that are not either manufactured or approved by Flymo/Partner, or by the machine having been modified in any way

## Environmental Information

Electrolux Outdoor Products are manufactured under an Environmental Management System (ISO 14001) using, where practical, components manufactured in the most environmentally responsible manner, according to company procedures, and with the potential for recycling at the end of the products' life.

- Packaging is recyclable and plastic components have been labelled (where practical) for categorised recycling.
- Awareness of the environment must be considered when disposing of 'end-of-life' product.
- If necessary, contact your local authority for disposal information.

## Certificate of Conformity

I, the undersigned P. Howells of Electrolux Outdoor Products, Aycliffe Industrial Estate, NEWTON AYCLIFFE, Co. Durham. DL5 6UP. Certify that a sample of the above product has been tested and found to comply with directives:- 89/392/EEC, 89/336/EEC, 73/23/EEC

I, the undersigned P. Howells of Electrolux Outdoor Products, Aycliffe Industrial Estate, NEWTON AYCLIFFE, Co. Durham. DL5 6UP. Certify that a sample of the above product has been tested using directive 81/1051/EEC as a guide. The maximum A-weighted sound pressure level recorded at operator position under free field semi anechoic chamber conditions was :-

I, the undersigned P. Howells of Electrolux Outdoor Products, Aycliffe Industrial Estate, NEWTON AYCLIFFE, Co. Durham. DL5 6UP. Certify that a sample of the above product has been tested using ISO 5349 as a guide. The maximum weighted root mean square value of vibration recorded at operator's hand position was:-

Type	ET20-6
Identification of Series	See Product Rating Label
Level	80.1 dB(A)

Type	ET20-6
Identification of Series	See Product Rating Label
Value	0.54 m/s <sup>2</sup>

Signed at  
**NEWTON**   
 AYCLIFFE.....1999

Signed at  
**NEWTON**   
 AYCLIFFE.....1999

Signed at  
**NEWTON**   
 AYCLIFFE.....1999

**Certificate of Conformity**

I, THE UNDERSIGNED: P. HOWELLS OF ELECTROLUX OUTDOOR PRODUCTS, AYCLIFFE INDUSTRIAL ESTATE, NEWTON AYCLIFFE, COUNTY DURHAM DL5 6UP ENGLAND

**Certify that the Trimmer**

- 1. Category ..... **Electric**
- 2. Make ..... **Flymo**  
Conforms to the specifications of Directive 84/538/EEC  
Type of Cutting Device ..... **Plastic Line**

<b>TYPE</b>	<b>Mini-Trim</b>
Identification of Series	SEE PRODUCT RATING LABEL
Engine/Motor-Manufacturer	Ametek
Cutting System Width	20 cm
Speed of Rotation of Cutting Device	11500 RPM
Tested by (laboratory)	SRL
Guaranteed sound power level	90 dB(A)

Signed at  
NEWTON AYCLIFFE  
Date 1999 .....





The use of eye protection is recommended to protect against objects thrown by the cutting line.

Flymo Safety Glasses are available from most leading stockists

**GUIDE PRICE  
ONLY £3.49**

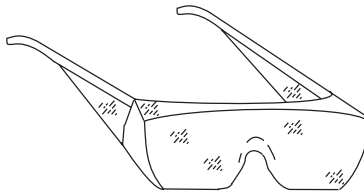

**GUIDE PRICE  
ONLY £3.49**

Contact your nearest stockist or telephone  
(01325) 300303 for more details

Electrolux Outdoor Products  
Aycliffe Industrial Estate  
NEWTON AYCLIFFE  
Co.Durham DL5 6UP  
ENGLAND

Telephone - (00) 44 1325 300303 Fax - (00) 44 1325 310339

UK Customer Helpline - 01325 300303 Fax - 01325 310339

Our policy of continuous improvement means that the specification of products may be altered from time to time without prior notice. Electrolux Outdoor Products. manufacture products for a number of well known brands under various registered patents, designs and trademarks in several countries.

© Electrolux Outdoor Products Ltd. Registered Office, Electrolux Works, Oakley Road, Luton LU4 9QQ  
Registered number 974979 England

**5118178-01 (01/99)**



## Free Manuals Download Website

<http://myh66.com>

<http://usermanuals.us>

<http://www.somanuals.com>

<http://www.4manuals.cc>

<http://www.manual-lib.com>

<http://www.404manual.com>

<http://www.luxmanual.com>

<http://aubethermostatmanual.com>

Golf course search by state

<http://golfingnear.com>

Email search by domain

<http://emailbydomain.com>

Auto manuals search

<http://auto.somanuals.com>

TV manuals search

<http://tv.somanuals.com>