









Use & Care Manual

Electric Range

*ES100 Control with Coil Surface Elements
or Ceramic Glass Cooktop*



Welcome	2	
Important Safety Instructions ..	3-4	
Features at a Glance	5-6	
Before Setting Oven Controls ..	7	
Setting Surface Controls	8	
Oven Control Functions	9	
Setting Oven Controls	9-11	
Care & Cleaning	12-15	
Before You Call Solutions to Common Problems	16-17	
Warranty	Back Cover	

Visit the Frigidaire Web Site at:
<http://www.frigidaire.com>



Welcome & Congratulations

Questions?

1-800-944-9044

(United States)

1-905-565-9200

(Canada)

Please attach sales receipt
here for future reference.

Congratulations on your purchase of a new range! At **Electrolux Home Products**, we are very proud of our product and are completely committed to providing you with the best service possible. Your satisfaction is our number one priority.

We know you'll enjoy your new range and **Thank You** for choosing our product. We hope you consider us for future purchases.

PLEASE CAREFULLY READ AND SAVE THESE INSTRUCTIONS

This Use & Care Manual provides specific operating instructions for your model. Use your range only as instructed in this manual. These instructions are not meant to cover every possible condition and situation that may occur. Common sense and caution must be practiced when installing, operating and maintaining any appliance.

Please record your model and serial numbers below for future reference.

Model Number: _____

Serial Number: _____

Purchase Date: _____

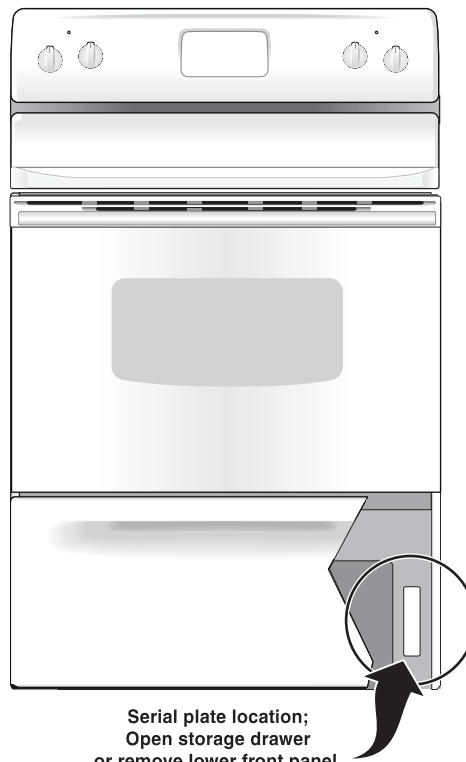

Serial plate location;
Open storage drawer
or remove lower front panel.

Product Registration

Register Your Product

The self-addressed **PRODUCT REGISTRATION CARD** should be filled in completely, signed and returned to Electrolux Home Products.

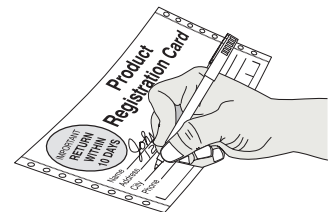

Versión en español

Si desea obtener una copia en español de este Manual del Usuario, sírvase escribir a la dirección que se incluye a continuación. Solicite la P/N 316257114 (ESP).

Spanish Use & Care Manual
Electrolux Home Products
P. O. Box 212378
Augusta, GA 30917

This Use & Care Manual contains general operating instructions for your range and feature information for several models. Your range **may not** have all the described features. The graphics shown are representational. The graphics on your range may not look exactly like those shown.

Important Safety Instructions



**Read all instructions before using this appliance.
Save these instructions for future reference.**

This manual contains important safety symbols and instructions. Please pay attention to these symbols and follow all instructions given.

⚠ WARNING This symbol will help alert you to situations that may cause serious bodily harm, death or property damage.

⚠ CAUTION This symbol will help alert you to situations that may cause bodily injury or property damage.

- **Remove all tape and packaging before using the range.** Destroy the carton and plastic bags after unpacking the range. Never allow children to play with packaging material.
- **Proper Installation—Be sure your appliance is properly installed and grounded by a qualified technician in accordance with the National Electrical Code ANSI/NFPA No. 70 latest edition and local electrical code requirements.** Install only per installation instructions provided in the literature package for this range.
Ask your dealer to recommend a qualified technician and an authorized repair service. Know how to disconnect the power to the range at the circuit breaker or fuse box in case of an emergency.
- **User servicing—Do not repair or replace any part of the appliance unless specifically recommended in the manuals.** All other servicing should be done only by a qualified technician. This may reduce the risk of personal injury and damage to the range.
- **Never modify or alter the construction of a range by removing leveling legs, panels, wire covers, anti-tip brackets/screws, or any other part of the product.**

⚠ WARNING

- All ranges can tip.
- Injury to persons could result.
- Install anti-tip device packed with range.
- See Installation Instructions.



⚠ WARNING To reduce the risk of tipping, the range must be secured by properly installed anti-tip bracket provided with the range. To check if the bracket is installed properly, visually check that rear leveling leg is inserted into and fully secured by the anti-tip bracket by removing lower panel or storage drawer. For models with a warmer drawer, grasp the top rear edge of the range and carefully attempt to tilt it forward. Refer to the Installation Instructions for proper anti-tip bracket installation.



⚠ WARNING Stepping, leaning or sitting on the doors or drawers of this range can result in serious injuries and also cause damage to the range. Do not allow children to climb or play around the range. The weight of a child on an open door may cause the range to tip, resulting in serious burns or other injury.

⚠ WARNING Do not use the oven or warmer drawer (if equipped) for storage.

⚠ CAUTION Do not store items of interest to children in the cabinets above a range or on the backguard of a range. Children climbing on the range to reach items could be seriously injured.

⚠ WARNING Never Use Your Appliance for Warming or Heating the Room.

- **Storage in or on Appliance—Flammable materials should not be stored in an oven, warmer drawer, near surface units or in the storage drawer.** This includes paper, plastic and cloth items, such as cookbooks, plasticware and towels, as well as flammable liquids. Do not store explosives, such as aerosol cans, on or near the range.
- **Do Not Leave Children Alone—Children should not be left alone or unattended in the area where appliance is in use.** They should never be allowed to sit or stand on any part of the appliance.
- **DO NOT TOUCH SURFACE UNITS, AREAS NEAR THESE UNITS, HEATING ELEMENTS OR INTERIOR SURFACES OF THE OVEN.** Both surface units and oven heating elements may be hot even though they are dark in color. Areas near surface units may become hot enough to cause burns. During and after use, do not touch, or let clothing or other flammable materials touch these areas until they have had sufficient time to cool. Among these areas are the cook top, surfaces facing the cook top, the oven vent openings and surfaces near these openings, oven door and window.
- **Wear Proper Apparel—Loose-fitting or hanging garments should never be worn while using the appliance.** Do not let clothing or other flammable materials contact hot surfaces.
- **Do Not Use Water or Flour on Grease Fires—Smother the fire with a pan lid, or use baking soda, a dry chemical or foam-type extinguisher.**
- **When heating fat or grease, watch it closely.** Fat or grease may catch fire if allowed to become too hot.
- **Use Only Dry Potholders—Moist or damp potholders on hot surfaces may result in burns from steam.** Do not let potholders touch hot heating elements. Do not use a towel or other bulky cloth instead of a potholder.
- **Do Not Heat Unopened Food Containers—Buildup of pressure may cause container to burst and result in injury.**
- **Remove the oven door from any unused range if it is to be stored or discarded.**

IMPORTANT—Do not attempt to operate the range during a power failure. If the power fails, always turn off the range. If the range is not turned off and the power resumes, the range will begin to operate again. Once the power resumes, reset the clock and oven function.



Important Safety Instructions

IMPORTANT INSTRUCTIONS FOR USING YOUR COOKTOP

- **Know which knob controls each surface heating unit.** Place a pan of food on the unit before turning it on, and turn the unit off before removing the pan.
- **Use Proper Pan Size**—This appliance is equipped with one or more surface units of different sizes. Select utensils having flat bottoms large enough to cover the surface unit heating element. The use of undersized utensils will expose a portion of the heating element to direct contact and may result in ignition of clothing. Proper relationship of utensil to element will also improve efficiency.
- **Utensil Handles Should Be Turned Inward and Not Extend Over Adjacent Surface Elements**—To reduce the risk of burns, ignition of flammable materials, and spillage due to unintentional contact with the utensil, the handle of the utensil should be positioned so that it is turned inward, and does not extend over adjacent surface units.
- **Never Leave Surface Elements Unattended at High Heat Settings**—Boilovers cause smoking and greasy spillovers that may ignite, or a pan that has boiled dry may melt.
- **Do Not Immerse or Soak Removable Heating Elements**—Heating elements should never be immersed in water. Heating elements clean themselves during normal operation.
- **Glazed Cooking Utensils**—Only certain types of glass, glass/ceramic, ceramic, earthenware, or other glazed utensils are suitable for cook top service without breaking due to the sudden change in temperature. Check the manufacturer's recommendations for cook top use.
- **When flaming foods under a ventilating hood, turn the fan on.**

IMPORTANT INSTRUCTIONS FOR CLEANING YOUR RANGE

- **Clean the range regularly to keep all parts free of grease that could catch fire.** Pay particular attention to the area underneath each surface element. Do not allow grease to accumulate.
- **Kitchen cleaners and aerosols**—Always follow the manufacturer's recommended directions for use. Be aware that excess residue from cleaners and aerosols may ignite causing damage and injury.
- **Clean Ventilating Hoods Frequently**—Grease should not be allowed to accumulate on the hood or filter. Follow manufacturer's instructions for cleaning.

FOR CERAMIC-GLASS COOK TOP MODELS

- **Do Not Cook on Broken Cook Top**—If cook top should break, cleaning solutions and spillovers may penetrate the broken cook top and create a risk of electric shock. Contact a qualified technician immediately.
- **Clean Cook Top with Caution**—If a wet sponge or cloth is used to wipe spills on a hot cooking area, be careful to avoid a steam burn. Some cleaners can produce noxious fumes if applied to a hot surface.

COIL COOK TOP MODELS

- **Make Sure Reflector Pans or Drip Bowls Are in Place**—Absence of these pans or bowls during cooking may subject wiring or components underneath to damage.
- **Protective Liners**—Do not use aluminum foil to line surface unit drip bowls, or reflector pans. Only use aluminum foil as recommended in this manual. Improper installation of these liners may result in risk of electric shock, or fire. Improper installation of these liners may result in risk of electric shock, or fire.

IMPORTANT INSTRUCTIONS FOR USING YOUR OVEN

- **Use Care When Opening Oven Door or Warmer Drawer (if equipped)**—Stand to the side of the range when opening the door of a hot oven. Let hot air or steam escape before you remove or replace food in the oven.
- **Keep Oven Vent Ducts Unobstructed.** The oven vent is located under the left rear surface element if your model is equipped with coil elements. The oven vent is located below the backguard for models equipped with ceramic-glass cook tops. Touching the surfaces in this area when the oven is operating may cause severe burns. Also, do not place plastic or heat-sensitive items on or near the oven vent. These items could melt or ignite.
- **Placement of Oven Racks.** Always place oven racks in desired location while oven is cool. If rack must be moved while oven is hot use extreme caution. Use potholders and grasp the rack with both hands to reposition. Do not let potholders contact the hot heating elements in the oven. Remove all utensils from the rack before moving.
- **Do not use the broiler pan without its insert.** The broiler pan and its insert allow dripping fat to drain and be kept away from the high heat of the broiler.
- **Do not cover the broiler insert with aluminum foil. Exposed fat and grease could ignite.**
- **Protective Liners**—Do not use aluminum foil to line the oven bottom. Only use aluminum foil as recommended in this manual. Improper installation of these liners may result in risk of electric shock, or fire.

IMPORTANT SAFETY NOTICE

The California Safe Drinking Water and Toxic Enforcement Act requires the Governor of California to publish a list of substances known to the state to cause cancer, birth defects or other reproductive harm, and requires businesses to warn customers of potential exposure to such substances.

Features At A Glance



Your Electric Range Features At a Glance

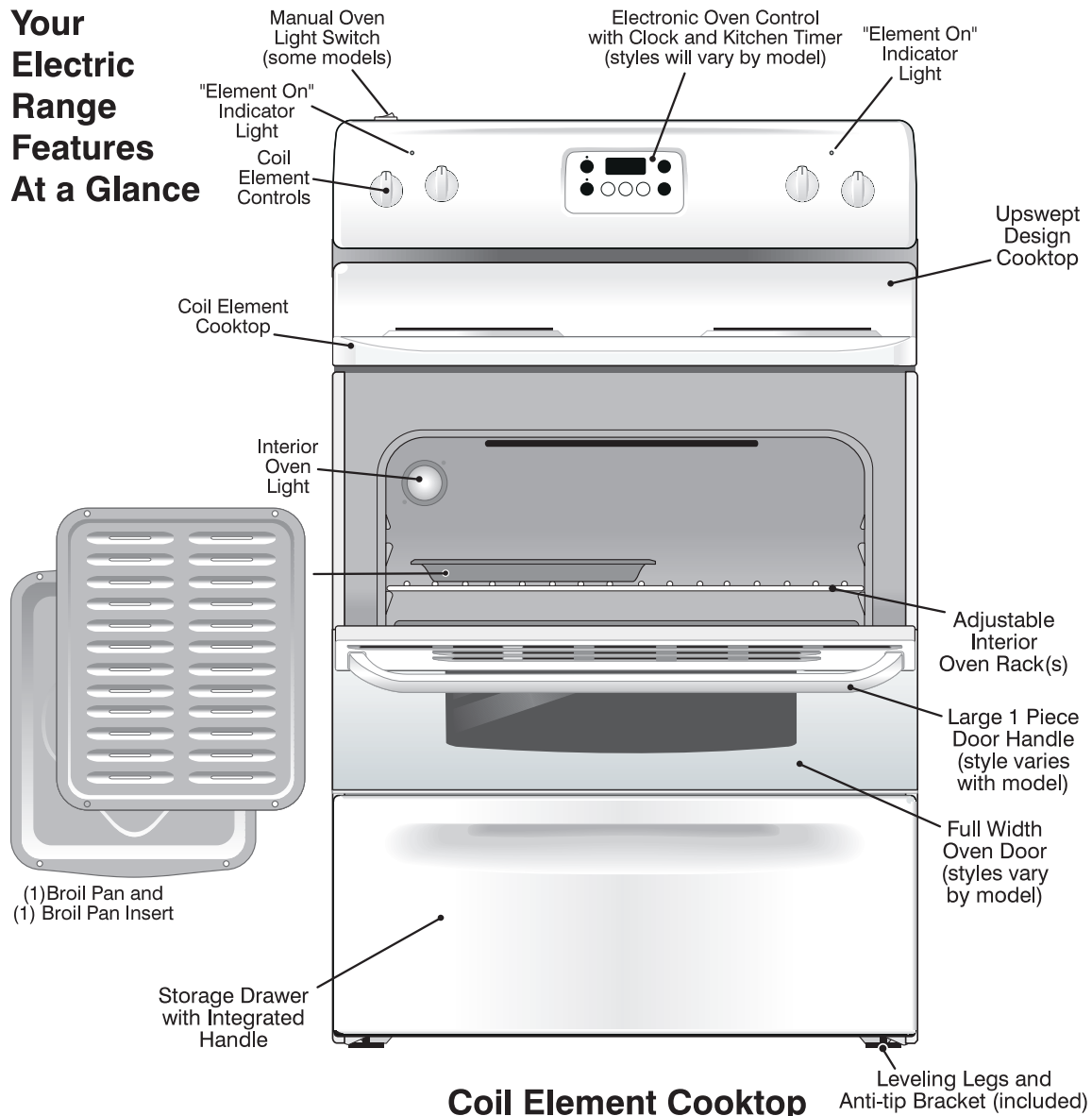

Coil Element Cooktop

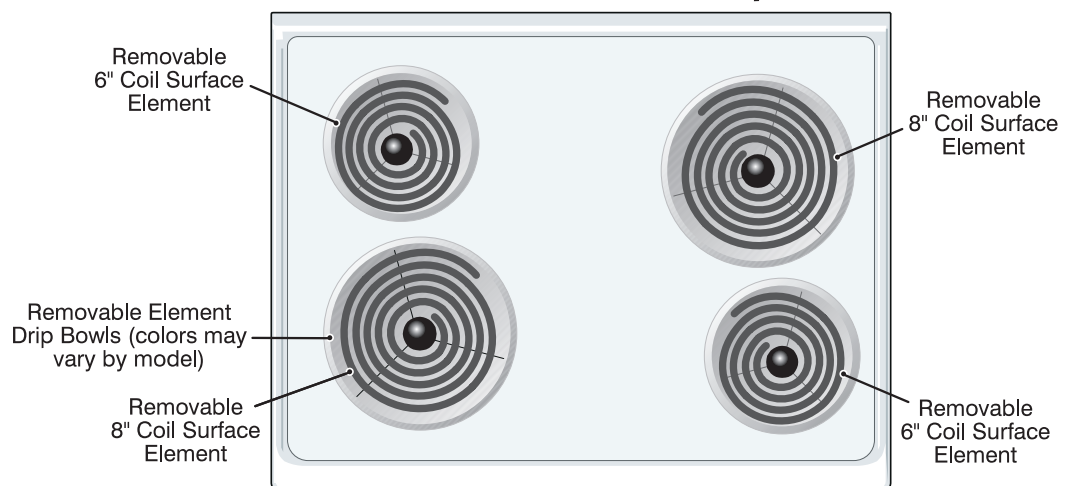

Features will vary and are shown for Coil Surface Element models only



Features At A Glance

Your Electric Range Features At a Glance

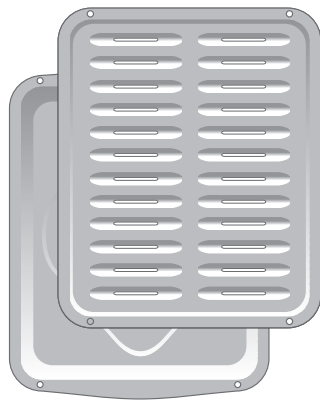
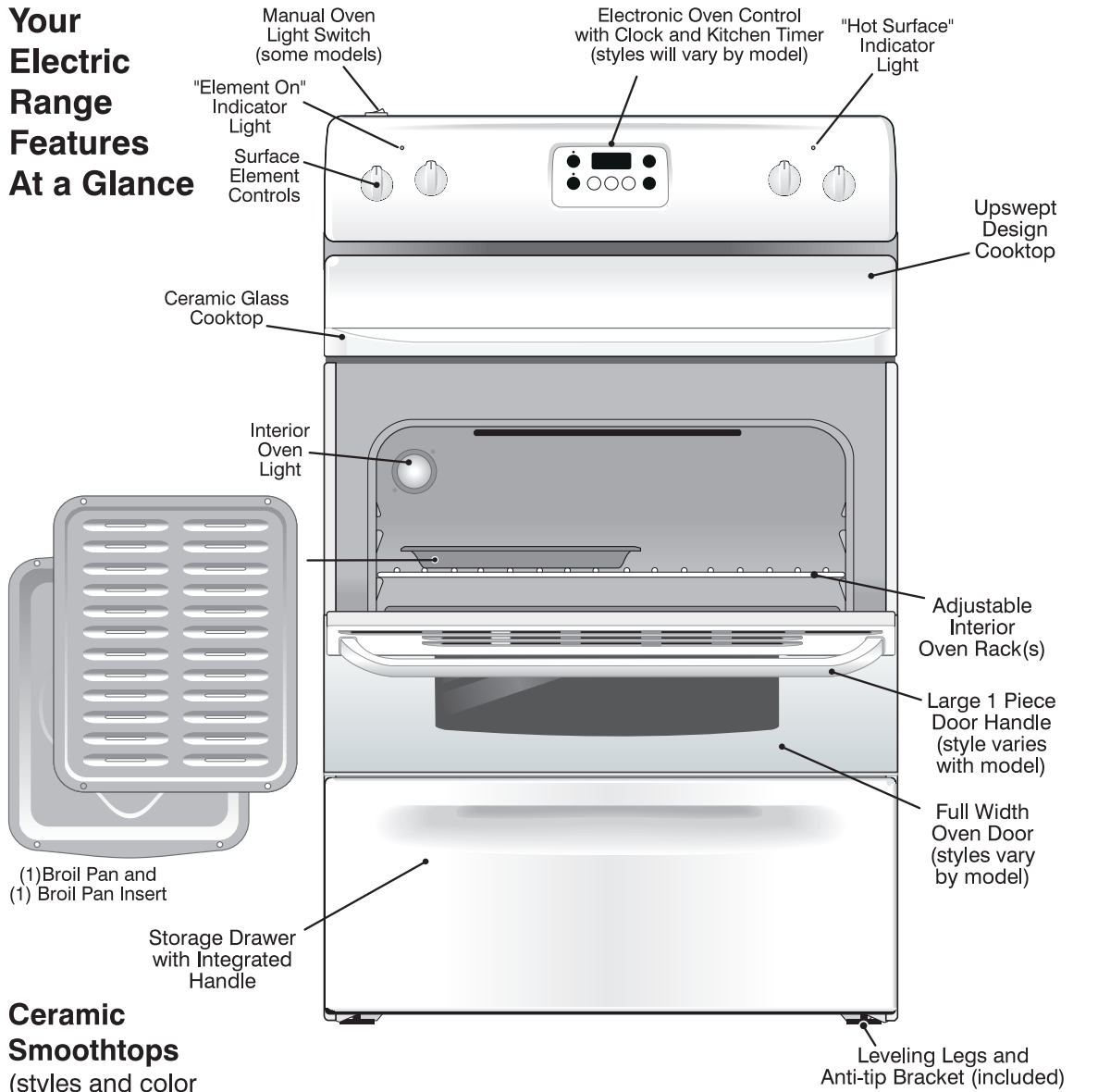

(1) Broil Pan and (1) Broil Pan Insert

Ceramic Smoothtops (styles and color vary by model)

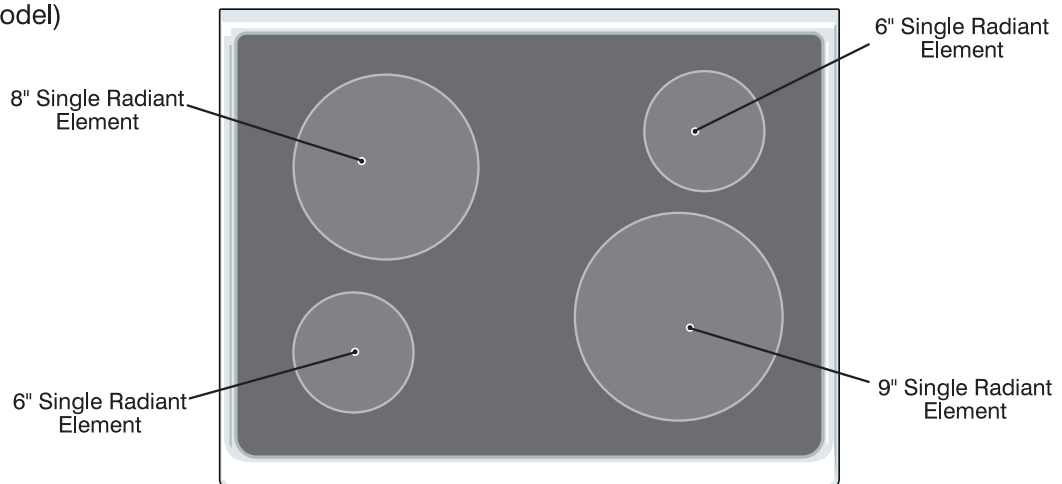

Features will vary and are shown for Ceramic Glass Cook Top models only

Before Setting Oven Controls

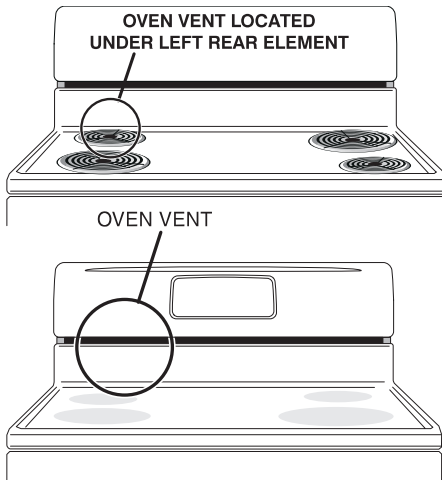

Oven Vent Location (for Coil Cook Top models only)

For models equipped with coil surface elements, the oven vent is located **under the left rear surface element**. When the oven is on, warm air flows through the left rear element. This venting is necessary for proper air circulation in the oven and good baking results. **DO NOT BLOCK THE OVEN VENT.**

Oven Vent Location (for Ceramic Cook Top models only)

For models equipped with ceramic glass cooktops, the oven vent is located **under the left rear side of the control panel**. When the oven is on, warm air is released through the vent. This venting is necessary for proper air circulation in the oven and good baking results. **DO NOT BLOCK OVEN VENT.**

Arranging Oven Racks

ALWAYS ARRANGE OVEN RACKS WHEN THE OVEN IS COOL (PRIOR TO OPERATING THE OVEN). Always use oven mitts when using the oven.

Removing & Replacing Oven Racks

To remove, pull the rack forward until it stops. Lift up front of rack and slide out. **To replace**, fit the rack onto the guides on the oven walls. Tilt the front of the rack upward and slide the rack back into place.

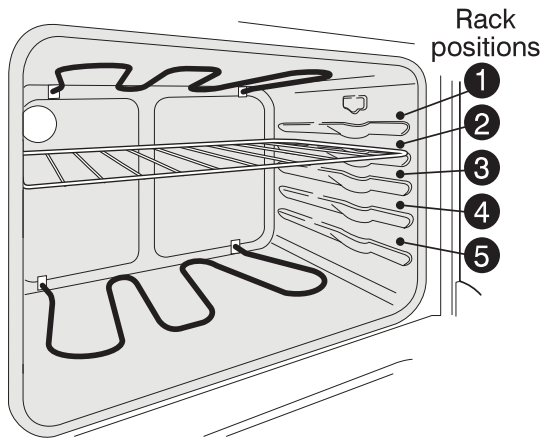

RECOMMENDED RACK POSITIONS FOR BROILING, BAKING & ROASTING

Food	Rack Position
Broiling meats, chicken or fish	1, 2 or 3
Cookies, cakes, pies, biscuits & muffins	3 or 4
Frozen pies, angel food cake, yeast, bread, casseroles, small cuts of meat or poultry	5
Turkey, roast or ham	5

Element On



Element On and Hot Surface Indicator Lights

The Coil Cook Top range is equipped with a surface control light that will glow on your range—the **Element On** indicator light.

The Ceramic Glass Cook Top range is equipped with two different surface control lights that will glow on your range—the **Element On** indicator light and a **Hot Surface** indicator light.

Hot Surface



The **Element On** (all models) located on the control panel, will glow when any surface element is turned on. A quick glance at this light after cooking is an easy check to be sure all surface controls are turned off.

The **Hot Surface** (Ceramic Glass Cook Top models only) indicator light, located on the control panel, will glow as the surface cooking area heats up and will **REMAIN ON** until the glass cooktop has cooled to a **MODERATE** level.

Setting Surface Controls



To Operate the Surface Elements (for Coil Cook Top models only)

1. Place cooking utensil on the surface element.
2. Push in and turn the surface control knob in either direction to the desired setting (See Figure 1). Start most cooking operations on a higher setting and then turn to a lower setting to finish cooking. The control knobs do not have to be set exactly on a particular setting. Use the settings as a guide and adjust the control knob as needed.
3. When cooking is completed, turn the surface element off before removing the pan. Note: The surface “**Element On**” indicator light(s) will glow when one or more elements are turned on. A quick glance at these indicator light(s) when cooking is finished is an easy check to be sure all surface elements are turned off.

To Operate Radiant Surface Elements (for Ceramic Glass Cook Top models only)

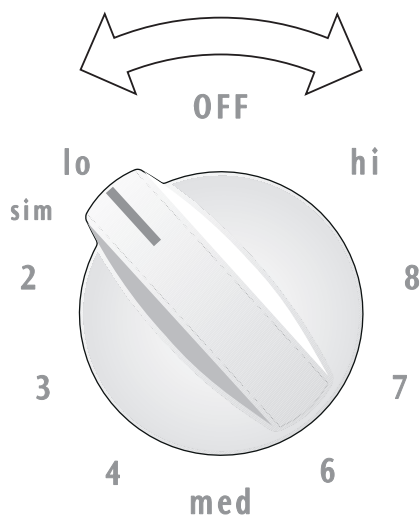

Figure 1

1. Place correctly sized cookware on the radiant surface element.
2. Push in and turn the surface control knob in either direction to the desired setting (See Figure 1). Start most cooking operations on a higher setting and then turn to a lower setting to finish cooking. The surface control knobs do not have to be set exactly on a particular mark. Use the marks as a guide and adjust the control knob as needed. Each surface element provides a constant amount of heat at each setting. A glowing red surface heating area extending beyond the bottom edge of the cookware indicates the cookware is **too small** for the surface heating area.
3. When cooking is completed, turn the surface element off before removing the cookware. Note: the **Element On** indicator light will glow when one or more elements are turned on. A quick glance at the indicator light(s) when cooking is finished is an easy check to be sure all control knobs are turned off. The **Hot Surface** indicator light will continue to glow **AFTER** the control knob is turned to the “Off” position and will glow until the heating surface area has cooled sufficiently.

CAUTION Radiant surface elements may appear to have cooled after they have been turned off. **The glass surface may still be hot** and burns may occur if the glass surface is touched before it has cooled sufficiently.

Suggested Surface Control Settings (FOR ALL MODELS)

The suggested settings found in the chart below are based on cooking in medium-weight metal pans with lids. Settings may vary when using other types of pans. **Note:** The size and type of utensil used, and the amount and type of food being cooked will influence the setting needed for best cooking results.

SURFACE CONTROL SETTINGS

Setting	Type of Cooking
HIGH (HI - 9)	Start most foods, bring water to a boil, pan broiling
MEDIUM HIGH (7 - 8)	Continue a rapid boil, fry, deep fat fry
MEDIUM (5 - 6)	Maintain a slow boil, thicken sauces and gravies, steam vegetables
MEDIUM LOW (2 - 4)	Keep foods cooking, poach, stew
LOW (LO - 1)	Keep warm, melt, simmer

CAUTION Do not place plastic items such as salt and pepper shakers, spoon holders or plastic wrappings on top of the range when it is in use. These items could melt or ignite. Potholders, towels or wooden spoons could catch fire if placed too close to the element.

Oven Control Functions



READ THE INSTRUCTIONS CAREFULLY BEFORE USING THE OVEN. For satisfactory use of your oven, become familiar with the various functions of the oven as described below.

BAKE PAD—Used to select the bake function.

BROIL PAD— Used to select the variable broil function.

TIMER ON/OFF PAD— Used to set or cancel the minute timer. The minute timer does not start or stop cooking.

CLOCK SET PAD— Used to set the time of day.

CLEAR/OFF — Used to clear any function previously entered except the time of day and minute timer. Push **CLEAR/OFF** to stop cooking.

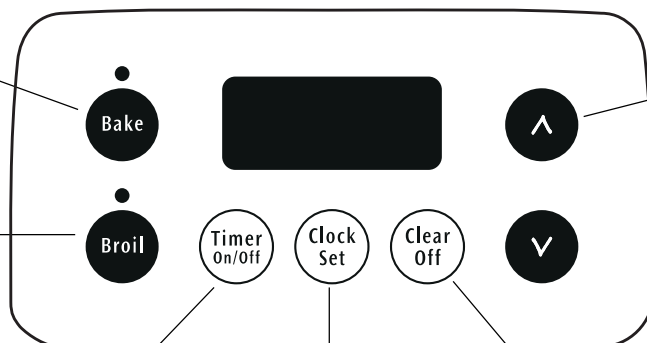

UP and DOWN ARROW PADS— Used along with the function pads to select oven temperature, time of day, clean time and minute timer.

Setting Oven Controls





Note: The time of day must first be set in order to operate the oven.

To Set the Clock

When the range is first plugged in, or when the power supply to the range has been interrupted, the display will flash "12:00".

1. Press .
2. Within 5 seconds, press and hold the  or  until the correct time of day appears in the display.

To Set the Minute Timer:



1. Press .
2. Press the  to increase the time in one minute increments. Press and hold the  to increase the time in 10 minute increments. The timer can be set for any amount of time from 1 minute to 11 hours and 59 minutes.

Note: If you press the  first, the timer will advance to 11 hours and 59 minutes.

3. The display shows the timer count down in minutes until one minute remains. Then the display will count down in seconds.
4. When the set time has run out, the timer will sound a 3 second beep. 0:00 will appear in the display until  is pressed.

Note: While the minute timer is counting down, the ":" will flash. The minute timer does not start or stop cooking. It serves as an extra timer in the kitchen that will beep when the set time has run out. The minute timer can be used alone or during any of the other oven functions. When the minute timer is in use with any other function, the minute timer will be shown in the display. To view other functions, press the pad for that function.

To Change the Minute Timer while it is in use:

While the timer is active and shows in the display, press and hold the  or  to increase or decrease the time.

To Cancel the Minute Timer before the set time has run out: Press .



Setting Oven Controls

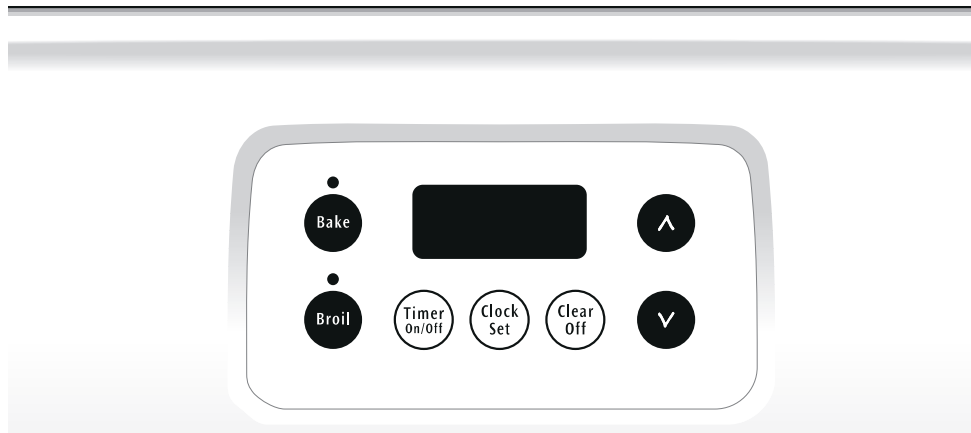

To Set or Change the Temperature for Baking

The oven can be programmed to bake at any temperature from 170°F to 500°F.

To Set the Controls for Baking:

1. Press **Bake** . "— — —°" appears in the display.
2. Within 5 seconds, press the **^** or **v** . The display will show "350°F." By pressing and holding the **^** or **v** , the temperature can then be adjusted in 5°F increments.
3. When the **^** or **v** is released, the oven will begin heating to the selected temperature. When the displayed temperature reaches the desired baking temperature, the control will beep once (1 time).
4. To cancel the baking function, press **Clear Off** .

To Change the Oven Temperature after Baking has Started:

1. Press **Bake** and make sure the bake temperature is displayed.
2. Press the **^** or **v** to increase or decrease the set temperature.

Setting Oven Controls

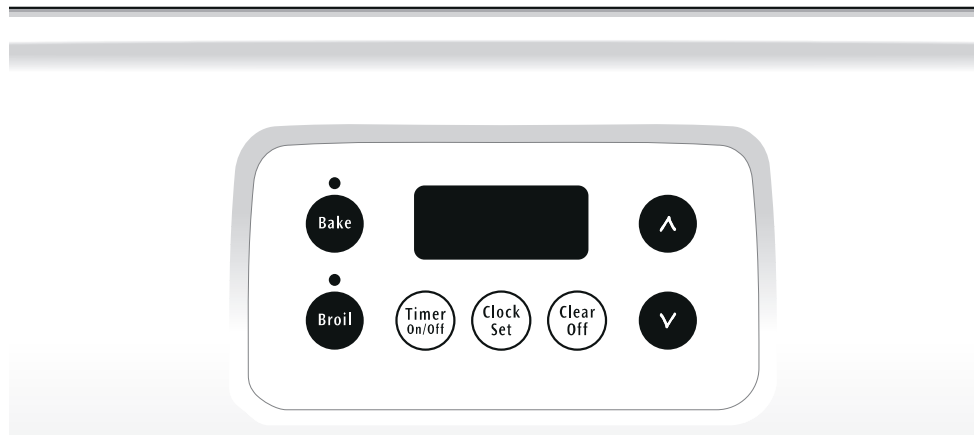

The broiler pan and the insert allows grease to drain and be kept away from the high heat of the broiler. **DO NOT** use the pan without the insert. **DO NOT** cover the insert with foil; the exposed grease could ignite.

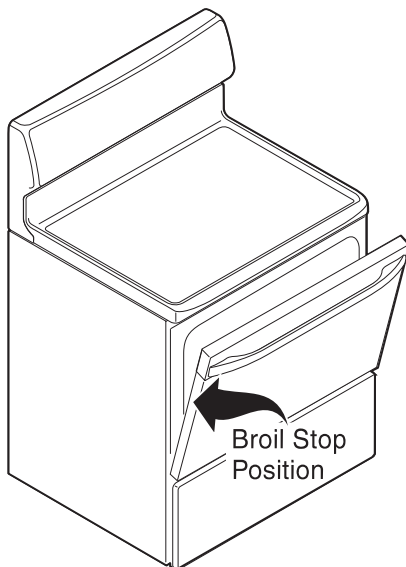
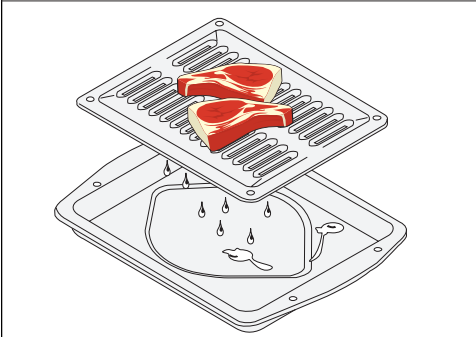

To Broil

1. Arrange oven rack while oven is still cool. Position the rack as suggested in the chart below.

Rack Position From Top	Food
1	Rare steaks
2	Fish, medium steaks, hamburgers and chops
3	Well-done foods such as chicken and lobster

2. Press **Broil**.
3. Press and hold the **▲** or **▼** until the desired broil setting level appears in the display. Press the **▲** for **HI** broil or the **▼** for **LO** broil. Most foods can be broiled at the **HI** broil setting. Select the **LO** broil setting to avoid excess browning or drying of foods that should be broiled to the well-done stage.
4. Place the insert on the broiler pan, then place the food on the insert. **DO NOT** use the broiler pan without the insert or cover the insert with aluminum foil. The exposed grease could ignite.
5. Place the pan on the oven rack. **Open the oven door to the broil stop position when broiling** (see illustration).
6. Broil on one side until food is browned; turn and cook on the second side. **Note:** Always pull the rack out to the stop position before turning or removing food.
7. When broiling is finished, press **Clear Off**.

CAUTION Should an oven fire occur, close the oven door and turn off the oven. If the fire continues, use a fire extinguisher. **DO NOT** put water or flour on the fire. Flour may be explosive.

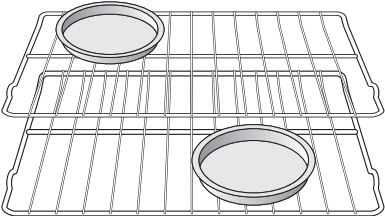
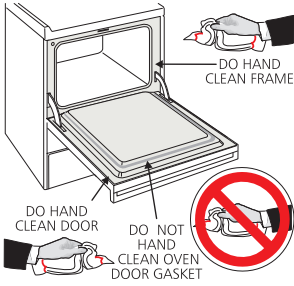

Care & Cleaning

Surfaces	How to Clean
Aluminum (Trim Pieces) & Vinyl	Use hot, soapy water and a cloth. Dry with a clean cloth.
Painted and Plastic Control Knobs, Body Parts, and Decorative Trim	<i>For general cleaning</i> , use hot, soapy water and a cloth. <i>For more difficult soils and built-up grease</i> , apply a liquid detergent directly onto the soil. Leave on soil for 30 to 60 minutes. Rinse with a damp cloth and dry. DO NOT use abrasive cleaners on any of these materials; they can scratch. To remove control knobs, turn to the OFF position; grasp firmly and pull straight off the shaft. To replace knobs after cleaning, line up the flat sides of both the knob and the shaft; then push the knob into place.
Painted Control Panel, Decorative Trim	<i>Before cleaning the control panel</i> , turn all controls to OFF and remove the control knobs. To remove, pull each knob straight off the shaft. Clean using hot, soapy water and a dishcloth. Rinse with a clean water using a dishcloth. Be sure to squeeze excess water from the cloth before wiping the panel; especially when wiping around the controls. Excess water in or around the controls may cause damage to the appliance. To replace knobs after cleaning, line up the flat sides of both the knob and the shaft; then push the knob into place.
Stainless Steel (some models)	Clean stainless steel with hot, soapy water and a dishcloth. Rinse with clean water and a cloth. Do not use cleaners with high concentrations of chlorides or chlorines. Do not use harsh scrubbing cleaners. Only use kitchen cleaners that are especially made for cleaning stainless steel. Always be sure to rinse the cleaners from the surface as bluish stains may occur during heating that cannot be removed.
Porcelain Enamel Broiler Pan and Insert, Door Liner, Body Parts, Warmer Drawer (if equipped)	Gentle scouring with a soapy scouring pad will remove most spots. Rinse with a 1:1 solution of clear water and ammonia. <i>If necessary</i> , cover difficult spots with an ammonia-soaked paper towel for 30 to 40 minutes. Rinse with clean water and a damp cloth, and then scrub with a soap-filled scouring pad. Rinse and wipe dry with a clean cloth. Remove all cleaners or the porcelain may become damaged during future heating. DO NOT use spray oven cleaners on the cooktop.
Oven Racks 	Oven racks may be removed or left in the oven during the self-clean cycle for cleaning. If removed, clean by using a mild, abrasive cleaner following manufacturer's instructions. Rinse with clean water and dry. If the racks are cleaned in the self-clean cycle, their color will turn slightly blue and the finish will be dull. After the self-clean cycle is complete, and the oven has cooled, rub the sides of the racks with wax paper or a cloth containing a small amount of baby oil or salad oil (this will make the racks glide easier into the rack positions).
Oven Door 	To clean oven door, wash with hot, soapy water and a clean cloth. DO NOT immerse the door in water. DO NOT clean the oven door gasket. The oven door gasket is made of a woven material, on self cleaning models, which is essential for a good seal. Care should be taken not to rub, damage or remove the gasket.
Ceramic Cooktop	See Cooktop Cleaning and Maintenance in the Care & Cleaning section.

Care & Cleaning



Cleaning Oven Bottom

The bake element is designed to be gently tilted up using your hand from the front of the bake element. This will allow easier access to the oven bottom for cleaning. Be careful not to raise the element more than 4 or 5 inches from the resting position.

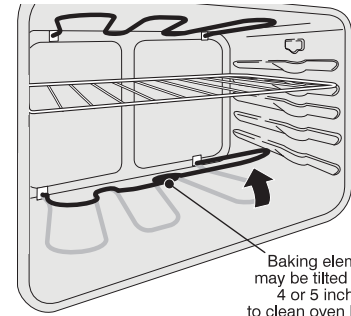

Cooktop Cleaning and Maintenance (for Ceramic Cooktop models only)

Consistent and proper cleaning is essential to maintaining your ceramic glass cooktop.

Prior to using your cooktop for the first time, apply the recommended cooktop cleaning cream to the glass surface. Buff with a non-abrasive cloth or pad. This will make cleaning easier when soiled from cooking. The special cooktop cleaning cream leaves a protective finish on the glass to help prevent scratches and abrasions.

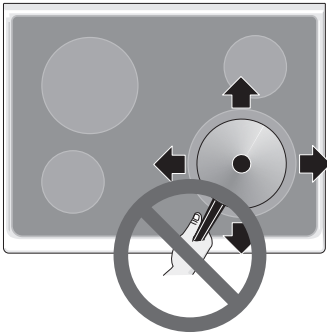

Sliding aluminum or copper clad bottom pans on the cooktop can cause metal markings on the cooktop surface. These marks should be removed **immediately** after the cooktop has cooled using the cooktop cleaning cream. Metal marks can become permanent if not removed prior to future use.

Cookware (cast iron, metal, ceramic or glass) with rough bottoms can mark or scratch the cooktop surface. **Do not slide anything metal or glass** across the cooktop. **Do not** use your cooktop as a cutting board or work surface in the kitchen. **Do not** cook foods directly on the cooktop surface without a pan. **Do not** drop heavy or hard objects on the glass cooktop, they may cause it to crack.

CAUTION Before cleaning the cooktop, be sure the controls are turned to **OFF** and the cooktop is **COOL**.

WARNING **DO NOT** use a cooktop cleaner on a hot cooktop. The fumes can be hazardous to your health, and can chemically damage the ceramic-glass surface.

For light to moderate soil

Use a non-abrasive pad, cloth or paper towel with the cooktop cleaning cream to apply on the cooktop surface. Buff surface until all soils and creams are removed. Mild dishwashing detergent with water may also be used. Make sure the cooktop is rinsed thoroughly, leaving no detergent or cleaner residue.

For heavy, burned on soil

Use the same method as for light to moderate soil. Re-apply the cooktop cleaning cream and cover with a wet paper towel. Let stand for about thirty minutes to loosen soil from surface. Scrub with cloth to remove remaining soil.

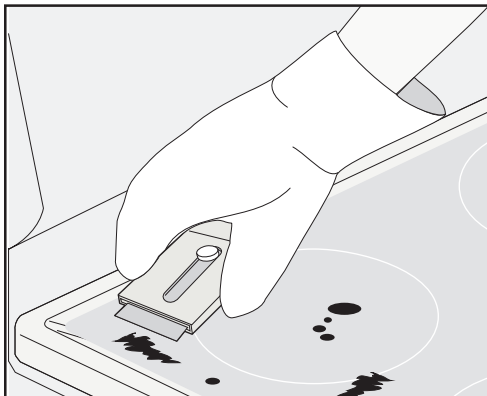

If soils remain, carefully scrape soils with a metal razor blade scraper, holding scraper at a 30 degree angle to the surface. Remove loosened soils with cooktop cleaning cream and buff surface clean.

Plastic or foods with a high sugar content

These types of soils need be removed immediately if spilled or melted onto the ceramic cooktop surface. Permanent damage (such as pitting of the cooktop surface) may occur if not removed **immediately**. After turning the surface elements **OFF**, use a razor blade scraper or a metal spatula with a mitt and scrape the soil from the hot surface (as illustrated). Allow the cooktop to cool, and use the same method for heavy or burned on soils.



Care & Cleaning

Cleaning Recommendations for Ceramic Glass Cooktop (for Glass Cooktop models only)



Do not use the following on the ceramic glass cooktop:

- Do not use abrasive cleaners and scouring pads, such as metal and some nylon pads. They may scratch the cooktop, making it more difficult to clean.
- Do not use harsh cleaners, such as chlorine bleach, ammonia or oven cleaners, as they may etch or discolor the cooktop.
- Do not use dirty sponges, cloths or paper towels, as they can leave soil or lint on the cooktop which can burn and cause discoloration.

Note: Additional cooktop cleaning cream may be ordered by visiting the Frigidaire website at <http://www.frigidaire.com>.

Care and Cleaning of Stainless Steel (some models)

Some models are equipped with stainless steel exterior parts. Special care and cleaning are **required** for maintaining the appearance of stainless parts. Please refer to the table provided at the beginning of the **Care & Cleaning** section in this Use & Care Manual.

Cleaning Recommendations for Coil Element Cooktop (for Coil Cooktop models only)

Surface elements can be unplugged and removed to make cleaning the drip pans easier. The surface elements clean themselves when they are turned on. Food spilled on a hot element will burn off. Food spilled on a cool element may be cleaned with a damp cloth—any remaining soil will burn off the next time the element is used.

CAUTION Be sure the range is cool before removing elements or drip bowls. Be careful not to bend terminal ends when replacing elements after cleaning.

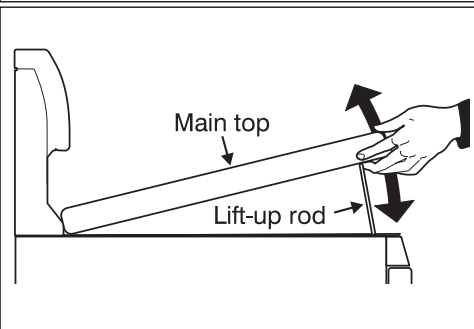
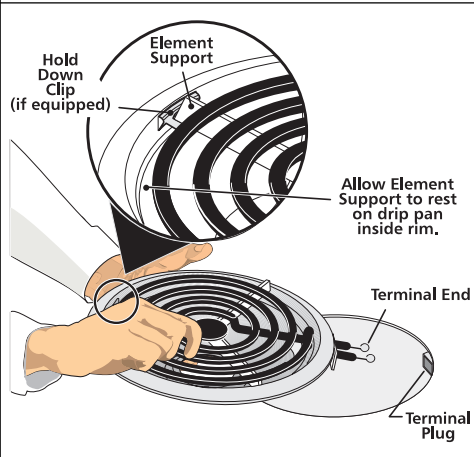

CAUTION Never immerse a surface element in water.

To Remove the Surface Elements and Drip Bowls

1. Lift the edge of the drip bowl across from the terminal end. **Lift the surface element and drip bowl together** just enough to clear the cooktop.
2. While holding the drip bowl and surface element, gently pull the terminal end out from the terminal plug. If equipped, **DO NOT** remove the hold down clip from the drip bowl.

To Clean Drip Bowls

Wash in hot, soapy water or in the dishwasher. Rinse and dry while still warm. Hard to remove, burned on soil can be removed by soaking the drip bowls for about 20 minutes in a lightly diluted liquid cleanser or a solution of ammonia and water (1/2 cup ammonia to 1 gallon of water). A nylon scrubber may be used after soaking. **DO NOT** use abrasive cleaners or steel wool, as they will scratch the surface. Always rinse with clean water and polish dry with a soft cloth.

To Replace Drip Bowls and Surface Elements

1. Slide the terminal end on the element through the opening in the drip bowl.
2. Align the element support to rest on the rim inside the drip bowl. If your drip bowl is equipped with a hold down clip, align the element support opposite the terminal end with the slot in the hold down clip, and snap into place.
3. After the element is positioned in the drip bowl, line up the terminal end with the terminal plug as shown.
4. Hold the surface element and drip bowl together as level as possible and firmly push the terminal end into the terminal plug. Make sure element terminal is seated properly into terminal plug. Make sure the surface element is level to reduce the hazard of pans sliding off the element.

Care & Cleaning



CAUTION When lowering the lift-up range top, grasp the sides with fingertips only. Be careful not to pinch fingers. **DO NOT** drop or bend the range top when raising or lowering. This could damage the surface.

To Raise the Top for Cleaning (for Coil Cooktop models only)

1. Grasp the sides and lift from the front. Lift-up rods will support the top in a raised position. Only lift the top far enough to allow the support rods to snap into place.
2. Clean underneath using a clean cloth and hot, soapy water.
3. To lower the top, gently push back on each rod to release the notched support. Hold the range top and slide the lift rods down into the range frame.

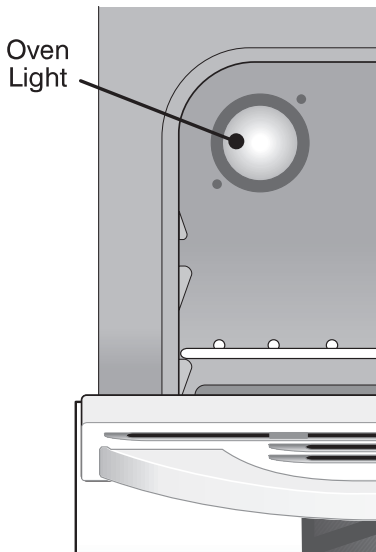

Changing the Oven Light (some models)

On some models, the oven light automatically turns on when the door is opened. Some models have a switch located on the control panel to turn on the light. The oven light is located at the rear of the oven.

To replace the oven light:

1. Turn electrical power off at the main source or unplug the range.
2. Replace bulb with a new 40 watt appliance bulb.
3. Turn power back on again at the main source (or plug the range back in).
4. The clock will then need to be reset. To reset, see **Setting Oven Controls** in this Use & Care Manual.

CAUTION Be sure the range is unplugged and all parts are COOL before replacing oven light. Wear a leather-faced glove for protection against possible broken glass.

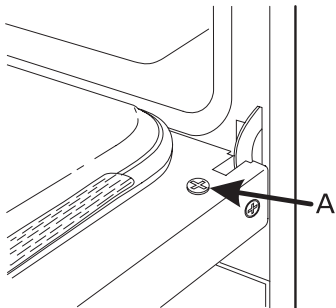

To Remove and Replace Oven Door

To Remove Oven Door:

1. Open the door.
2. Remove screws located on the inside of the oven door near the hinges **A** (one on each side.)
3. Close the door to the quarter-open position. Grasp the door firmly on both sides and lift up and off the hinges.
4. To clean oven door, follow the instructions provided in the **Care & Cleaning** table.

To Replace Oven Door:

1. Be sure the hinge arms are in the quarter-open position. Be careful if pulling the hinges open by hand. The hinges may snap back against the oven frame and could pinch fingers.
2. Hold the door at the sides near the top. Insert the hinge arms into slots at the bottom of the door.
3. Hinge arms must go into the range slots evenly. The hinge arms should be inserted into the bottom corners of the door as far as they can go.
4. If the door is not in line with the oven frame, remove it and repeat the above steps.

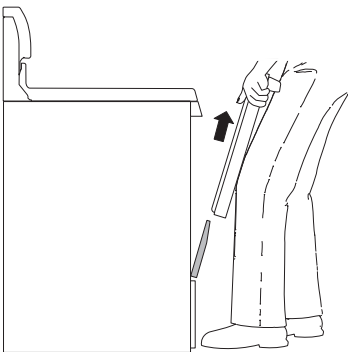

CAUTION The door is heavy. For safe, temporary storage, lay the door flat with the inside of the door facing down.



Before You Call

Solutions to Common Problems

Before you call for service, review this list. It may save you time and expense. The list includes common occurrences that are not the result of defective workmanship or materials in this appliance.

OCCURRENCE

POSSIBLE CAUSE/SOLUTION

Range is not level.

Poor installation. Place oven rack in center of oven. Place a level on the oven rack. Adjust leveling legs at base of range until the oven rack is level.

Be sure floor is level and is strong and stable enough to adequately support range.

If floor is sagging or sloping, contact a carpenter to correct the situation.

Kitchen cabinet alignment may make range appear unlevel. Be sure cabinets are square and have sufficient room for range clearance.

Cannot move appliance easily. Appliance must be accessible for service.

Cabinets not square or are built in too tightly. Contact builder or installer to make appliance accessible.

Carpet interferes with range. Provide sufficient space so range can be lifted over carpet.

Surface element too hot or not hot enough.

Incorrect control setting. Be sure the correct control is on for the element to be used.

Surface element does not heat.

Lightweight or warped pans used. Use only flat, evenly balanced, medium or heavyweight cookware. Flat pans heat better than warped pans. Cookware materials and weight of the material affect heating. Heavy and medium-weight pans heat evenly. Because lightweight pans heat unevenly, foods may burn easily.

No power to the appliance. Check steps under "Entire Appliance Does Not Operate" in this **Before You Call** checklist.

Incorrect control setting. Make sure the correct control is on for the surface unit to be used.

Entire appliance does not operate.

Make sure cord/plug is plugged tightly into outlet.

Service wiring is not complete. Contact your dealer, installing agent or authorized servicer.

Power outage. Check house lights to be sure. Call your local electric company for service.

Oven light (some models) does not work.

Replace or tighten bulb. See **Changing Oven Light** (some models) in this Use & Care Manual for instructions.

Oven control beeps continuously with no indicator lights flashing. (If model is equipped with a display F1 or F3 will show.)

This oven is equipped with a state of the art electronic oven control. Among its many features is a full time oven circuit diagnostics system. The control constantly monitors its internal circuitry as well as several crucial oven circuits to insure they are all operating correctly. If at any time one of these systems fails, the control will immediately stop operation, and beep continuously (flashing an error code of F1 or F3 in the display window, if equipped). Electronic control has detected a fault condition. Push **CLEAR/OFF** to clear the display and stop the beeping. Reprogram oven. If fault recurs, record fault number, push **CLEAR/OFF** and contact an authorized servicer.

Before You Call

Solutions to Common Problems



Oven smokes excessively during broiling.	<p>Control(s) not set properly. Follow instructions under Setting Oven Controls.</p> <p>Make sure oven door is opened to broil stop position.</p> <p>Meat too close to the element. Reposition the rack to provide proper clearance between the meat and the element. Preheat broil element for searing.</p> <p>Meat not properly prepared. Remove excess fat from meat. Cut remaining fatty edges to prevent curling, but do not cut into lean.</p> <p>Insert on broiler pan wrong side up and grease not draining. Always place grid on the broiler pan with ribs up and slots down to allow grease to drip into pan.</p> <p>Grease has built up on oven surfaces. Regular cleaning is necessary when broiling frequently. Old grease or food spatters cause excessive smoking.</p>
Poor baking results.	<p>Many factors affect baking results. Make sure the proper rack position is used. Center food in the oven and space pans to allow air to circulate. Allow the oven to preheat to the set temperature before placing food in the oven. Try adjusting the recipe's recommended temperature or baking time.</p>
Flames inside oven or smoking from vent.	<p>Excessive spillovers in oven. This is normal, especially for high oven temperatures with pie spillovers or large amounts of grease on bottom of oven. Wipe up excessive spillovers.</p> <p>For oven fire, see Setting Surface & Oven Controls in this Use & Care Manual.</p>
Drip bowls are pitting or rusting (Coil element models).	<p>Foods with acids, such as tomatoes, if allowed to stand in/on bowls will cause corrosion. Remove and wash drip bowls as soon as possible after a spillover</p> <p>Normal environment. Houses along sea coast are exposed to salt air. Protect bowls as much as possible from direct exposure to salt air.</p>
Drip bowls turning color or distorted (Coil element models).	<p>Bottom surface of cookware extends beyond surface elements and touches cooktop surface. This can cause high enough temperatures to discolor the drip bowls. DO NOT use cookware of this type. Pan sizes should be matched to the size of the element. Replacement drip bowls may be purchased from your dealer.</p>
Scratches or abrasions on cooktop surface (Ceramic-Glass cooktop models).	<p>Coarse particles such as salt or sand between cooktop and utensils can cause scratches. Be sure cooktop surface and bottoms of utensils are clean before usage. Small scratches do not affect cooking and will become less visible with time.</p> <p>Cleaning materials not recommended for ceramic-glass cooktop have been used. See "Cooktop Cleaning and Maintenance" in the Care & Cleaning section.</p> <p>Cookware with rough bottom has been used. Use smooth, flat-bottomed cookware.</p>
Metal marks (Ceramic-Glass cooktop models).	<p>Sliding or scraping of metal utensils on cooktop surface. Do not slide metal utensils on cooktop surface. Use a ceramic-glass cooktop cleaning creme to remove the marks. See "Cooktop Cleaning and Maintenance" in the Care & Cleaning section.</p>
Brown streaks or specks (Ceramic-Glass cooktop models).	<p>Boilovers are cooked onto surface. Use razor blade scraper to remove soil. See "Cooktop Cleaning and Maintenance" in the Care & Cleaning section.</p>
Areas of discoloration with metallic sheen (Ceramic-Glass cooktop models).	<p>Mineral deposits from water and food. Remove using a ceramic-glass cooktop cleaning creme. Use cookware with clean, dry bottoms.</p>

Notes

Notes



RANGE WARRANTY

Your range is protected by this warranty

	WARRANTY PERIOD	THROUGH OUR AUTHORIZED SERVICERS, WE WILL:	THE CONSUMER WILL BE RESPONSIBLE FOR:
FULL ONE-YEAR WARRANTY	One year from original purchase date.	Pay all costs for repairing or replacing any parts of this appliance which prove to be defective in materials or workmanship.	Costs of service calls that are listed under NORMAL RESPONSIBILITIES OF THE CONSUMER.*
LIMITED 2ND-5TH YEAR WARRANTY (Glass Smoothtop, Seal & Elements)	Second through fifth years from original purchase date.	Provide a replacement for any defective surface heating element, deteriorated rubberized-silicone seal (upswept models only), or glass smoothtop that cracks due to thermal breakage (not customer abuse).	Diagnostic costs and any transportation and labor costs which are required because of service.
LIMITED WARRANTY (Applicable to the State of Alaska)	Time periods listed above.	All of the provisions of the full and limited warranties above and the exclusions listed below apply.	Costs of the technician's travel to the home and any costs for pick up and delivery of the appliance required because of service.

In the U.S.A., your appliance is warranted by Electrolux Home Products North America, a division of White Consolidated Industries, Inc. We authorize no person to change or add to any of our obligations under this warranty. Our obligations for service and parts under this warranty must be performed by us or an authorized Electrolux Home Products North America servicer. In Canada, your appliance is warranted by WCI Canada, Inc.

*NORMAL RESPONSIBILITIES OF THE CONSUMER

This warranty applies only to products in ordinary household use, and the consumer is responsible for the items listed below:

1. Proper use of the appliance in accordance with instructions provided with the product.
2. Proper installation by an authorized servicer in accordance with instructions provided with the appliance and in accordance with all local plumbing, electrical and/or gas codes.
3. Proper connection to a grounded power supply of sufficient voltage, replacement of blown fuses, repair of loose connections or defects in house wiring.
4. Expenses for making the appliance accessible for servicing, such as removal of trim, cupboards, shelves, etc., which are not a part of the appliance when it was shipped from the factory.
5. Damages to finish after installation.
6. Replacement of light bulbs and/or fluorescent tubes (on models with these features).

EXCLUSIONS

This warranty does not cover the following:

1. CONSEQUENTIAL OR INCIDENTAL DAMAGES SUCH AS PROPERTY DAMAGE AND INCIDENTAL EXPENSES RESULTING FROM ANY BREACH OF THIS WRITTEN OR ANY IMPLIED WARRANTY.
NOTE: Some states do not allow the exclusion or limitation of incidental or consequential damages, so this limitation or exclusion may not apply to you.
2. Service calls which do not involve malfunction or defects in workmanship or material, or for appliances not in ordinary household use. The consumer shall pay for such service calls.
3. Damages caused by services performed by servicers other than Electrolux Home Products North America or its authorized servicers; use of parts other than genuine Electrolux Home Products parts; obtained from persons other than such servicers; or external causes such as abuse, misuse, inadequate power supply or acts of God.
4. Products with original serial numbers that have been removed or altered and cannot be readily determined.

IF YOU NEED SERVICE

Keep your bill of sale, delivery slip, or some other appropriate payment record. The date on the bill establishes the warranty period should service be required. If service is performed, it is in your best interest to obtain and keep all receipts. This written warranty gives you specific legal rights. You may also have other rights that vary from state to state. Service under this warranty must be obtained by contacting Electrolux Home Products:

This warranty only applies in the 50 states of the U.S.A., Puerto Rico, and Canada. Product features or specifications as described or illustrated are subject to change without notice. All warranties are made by Electrolux Home Products North America, a division of White Consolidated Industries, Inc. In Canada, your appliance is warranted by WCI Canada, Inc.

03-U-RA-01 (rev. 01/2001)

USA

800•944•9044

Electrolux Home Products North America
P.O. Box 212378
Augusta, GA 30917

Canada

866•213•9397 (English)

866•294•9911 (French)

Electrolux Home Products North America
6150 McLaughlin Road
Mississauga, Ontario, Canada
L5R 4C2

Free Manuals Download Website

<http://myh66.com>

<http://usermanuals.us>

<http://www.somanuals.com>

<http://www.4manuals.cc>

<http://www.manual-lib.com>

<http://www.404manual.com>

<http://www.luxmanual.com>

<http://aubethermostatmanual.com>

Golf course search by state

<http://golfingnear.com>

Email search by domain

<http://emailbydomain.com>

Auto manuals search

<http://auto.somanuals.com>

TV manuals search

<http://tv.somanuals.com>