

1500/1 Art. 1498

- D** **Gebrauchsanweisung**
Accu-Pumpe
-
- GB** **Operating Instructions**
Battery Pump
-
- F** **Mode d'emploi**
Pompe sur accu
-
- NL** **Gebruiksaanwijzing**
Accupomp
-
- S** **Bruksanvisning**
Batteridriven pump
-
- I** **Istruzioni per l'uso**
Pompa a batteria
-
- E** **Manual de instrucciones**
Bomba con acumulador
-
- P** **Instruções de utilização**
Bomba com acumulador
-
- DK** **Brugsanvisning**
Akku-pumpe

GARDENA Battery Pump 1500/1

Welcome to the Garden of GARDENA ...



Please read the Instructions for Use carefully and follow the instructions contained in them. Get to know the battery pump, its correct use and the safety instructions with the assistance of these Instructions for Use.



For safety reasons, children and young persons under the age of 16 and people who have not read these Instructions for Use should not use this battery pump.

Intended use

→ Please keep these instructions in a safe place.

1. Area of Application of Your GARDENA Battery Pump	9
2. For Your Safety	9
3. Initial Operation	10
4. Operating	11
5. Maintenance	12
6. Trouble-Shooting	13
7. After Operation	13
8. Technical Data	14
9. Service	14

1. Area of Application of Your GARDENA Battery Pump

Purpose

The GARDENA battery pump is intended for private use in domestic gardens and allotments. It is intended for drawing rainwater (or clear sweet water) out of rainwater butts e.g. the GARDENA rainwater butt.

The battery pump is ideal for the operation of a sprayer, for emptying rain barrels and paddling pools and for filling a watering can easily.

The pump can withstand complete submersion (watertight encapsulation) and is submerged in the water (max. submersion depth 1.5 m).

Please note



The pump should not be used for the delivery of salt water, muddy water, corrosive, easily inflammable or explosive liquids (e. g. petrol, paraffin, thinners), oil, heating oil or food-stuffs.

The water temperature should not exceed 35 °C.

Attention! For risks of injury the Accu must not be used as power source for other devices.

The battery pump may only be operated with the battery supplied.

2. For Your Safety

→ Please comply with the safety instructions on the battery!



Warning!
Short-circuit – risk of fire

→ Do not bridge contacts with metal components.

Battery Safety**Danger of fire!**

- Never charge the battery near to acids and easily inflammable materials.

**Danger of Explosion!**

- Never throw a worn out battery on to an open fire.

The battery is not watertight, but can remain suspended on the rainwater butt in rain.

The battery connection line may not be used for attaching or transporting the pump. The pump can be submerged or raised via the telescopic pipe. Alternatively, a rope can be attached to the carrying handle to submerge, raise and secure the battery pump.

The battery may only be charged using the NL12 charger supplied as only the latter guarantees optimum technical harmonisation between the battery and the charger. Using other chargers may result in injury to persons/ damage to property. The use of other chargers will result in loss of all claims for liability and warranty claims against the manufacturer.

Never charge the Accu after having been heated up by operation or sun.

- Let it cool down first.

Never expose the Accu to direct sunlight while charging.

- Always detach the battery from the pump to charge it.

Fully discharging the battery can destroy it.

- Charge low battery immediately.

Only use the battery for the battery pump.

Under extreme conditions some accu acid could escape. This, however, does not represent a defect. Proceed as follows should the casing leak:

1. Immediately wash the affected area of the skin with soap and water.
2. Neutralize the accu acid with vinegar or lemon juice.
3. If accu acid should get into your eyes, rinse your eyes for at least 10 minutes with fresh water. Then contact your doctor immediately!

Inspection

Always inspect the battery pump (especially the connection line) before using it.

A damaged pump may not be used. If damaged, it is essential to have the pump checked by GARDENA Service.

Safety Instructions**Dry-running destroys the pump!**

- Switch the pump off immediately the conveyed fluid runs out (turn knob to "0").

- Comply with the minimum depth of water stipulated in the specification for the pump.

Do not allow the pump to run with the output side closed.

Electronic Circuit-Breaker

If overloaded, the pump is switched off by the electronic protective switch in the Accu. The motor starts again automatically when it has cooled down (see **6. Trouble-Shooting**).

Automatic Venting

The pump is fitted with a vent valve. The purpose of this vent valve is to remove any cushion of air present in the pump.

3. Initial Operation

We recommend using a GARDENA hose connection:

Art. (2)915/2025 for 13 mm (1/2"), **Art. (2)916/2026** for 16 mm (5/8") and **Art. 2817** for 19 mm (3/4") for connecting a garden hose.

The 1/2" hose should not be more than 20 m long.

A relatively higher water pressure (greater spraying power) is to be expected from the watering equipment when 19 mm (3/4") hose connections are used because the friction losses in the hose are lower.

Setting up the telescopic pipe on the container:

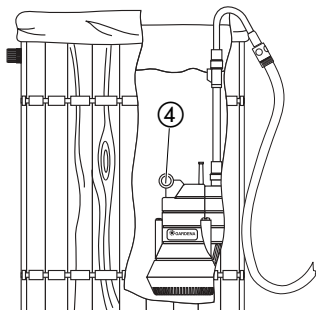

1. Screw telescopic pipe ① on the pump.
2. Release clamping sleeve ② of the telescopic pipe.
3. Adjust telescopic pipe stalk ③ to the height of the container. *The length of the telescopic pipe can be adjusted between 39–62 cm.*
4. Tighten clamping sleeve ② by hand.

The length of the telescopic pipe ③ should be set in such a way that the pump does not touch the bottom of the container. This prevents dirt in the container reaching the pump.

A rope must be run through the handle ④ of the pump for deeper water containers (max. 1.5 m).

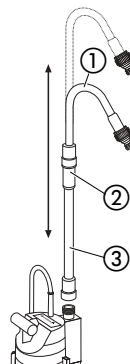

GB

Complete Solution:

- (a) the GARDENA Rain Water Collection Filter (Art. No. 3820 / 3821)
- (b) the GARDENA Connecting Set (Art. No. 3815),
- (c) the GARDENA Rain Water Tank (Art. No. 3801 / 3805)
- (d) the matching GARDENA Cover for Rain Water Tank (Art. No. 3800 / 3804), and
- (e) the GARDENA Battery Pump (Art. No. 1498).

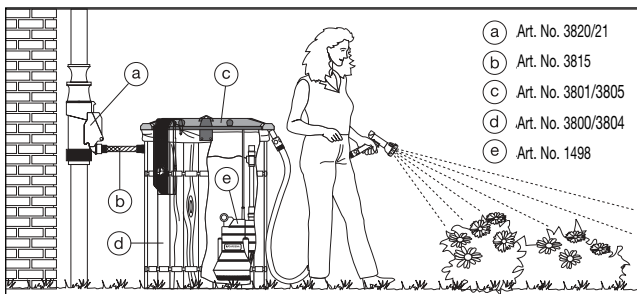

Use in shallow vessels:

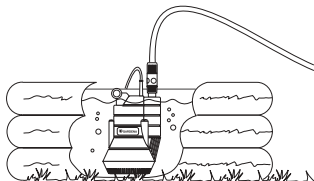

If the battery pump is used in flat containers, e.g. to empty a paddling pool, the telescopic pipe can be removed and replaced by the threaded tap connector supplied. The 13 mm (1/2"), 16 mm (5/8") or 19 mm (3/4") hose connection must be set up using Original GARDENA System hose connections.

4. Operating

Charging the battery:

The battery may only be charged using the NL-12 charger supplied or the solar panel, Art. 7851-00.620.00 with charging cable Art. 1498-20.600.22, obtainable from GARDENA Service. Operating the pump is not possible during charging!

The battery is partially charged in the works for safety reasons. The battery must be charged before it is used for the first time. As this NiCd-battery is subject to self-discharging, the battery must be charged up to reach a full charge if it has been stored for a relatively long time.

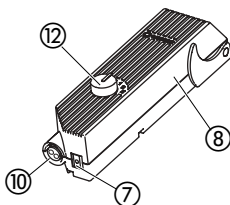
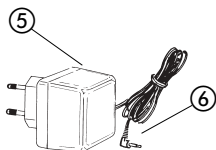

Pumping water out of the container:

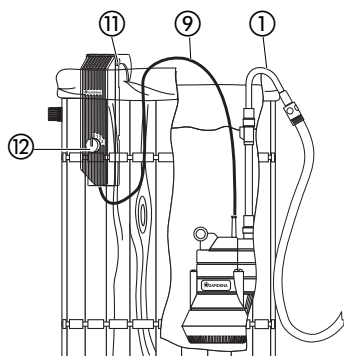

The outer surface and the contacts of the battery must be clean and dry before the charger is connected.

1. Plug charger ⑤ into a socket (230 V AC).
2. Plug equipment plug ⑥ into the charging socket ⑦ of the battery ⑧.
The charging process commences.
3. Disconnect equipment plug ⑥ from the charged battery and unplug the charger ⑤.

Charging time approx. 24 hours for the initial charge.
Afterwards, 12 - 24 hours depending on the state of charge.

The Accu reaches its full capacity only after numerous (approx. 5) charging/discharging processes.

1. Plug connection cable ⑨ of the pump into the connection socket ⑩ of the charged battery.
2. Suspend pump with telescopic pipe ① in the container.
3. Hang the battery on the outside of the container using the battery clip ⑪ –or– fix it outside, protected from falling into the container (e.g. on the wall).
4. Turn knob ⑫ on the battery to 1 to 3 depending on requirements. *The pump conveys the water.*

	Recommended purpose	Max. quantity conveyed / battery charge	Max. life of battery charge
Stage 0 : off	-	-	-
Stage 1 : low	e.g. pump out paddling pool	400 l *	60 min.
Stage 2 : mittel	e.g. spraying	330 l *	40 min.
Stage 3 : high	e.g. clean garden equipment	220 l *	20 min.

* Value was determined with 20 m (1/2") hose with GARDENA sprayer Art.1906.

The battery heats up during pumping. This is normal and does not impair its performance.

5. Maintenance

Cleaning the filter:

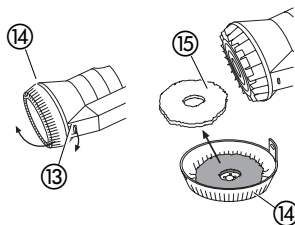

The GARDENA battery pump works largely without maintenance. If conveying dirty rainwater, the filter must be cleaned regularly.

The pump must not be used without a filter!

1. Release catch ⑬ manually from the housing and remove the suction foot ⑭.
2. Clean filter ⑮ under flowing water.
3. Insert filter ⑮ in the suction foot ⑭ again and push the suction foot on to the pump.

Cleaning the battery:

Never clean the battery under running water!

➔ If the battery is dirty, clean it with a soft, dry cloth.

6. Trouble-Shooting

Fault	Possible cause	Remedy
Pump running but does not deliver.	Air cannot escape because the pressure line is closed. Possible kink in the pressure hose.	→ Open the pressure line (e. g. shut-off valve, delivery units).
	Air in suction foot.	Wait for about max. 60 seconds until the pump has vented; if necessary, turn off and then on again.
	Suction foot / filter blocked.	→ Clean filter (see 5. Maintenance).
	Water level below minimum water level when starting the pump.	→ Submerge pump deeper. Minimum water depth of water is 5.5 cm.
Pump does not start, or stops suddenly during operation.	Electronic protective switch in the Accu has switched off the pump.	→ Clean filter (see 5. Maintenance). Comply with the maximum temperature for media conveyed (35 °C).
	Power connection interrupted.	→ Check connection cable and electrical plug and socket connections.
Pump is running but the delivery output drops suddenly.	Suction foot / filter blocked.	→ Clean the filter (see 5. Maintenance).
	Battery flat.	→ Charge the battery (see 4. Operating).

Attention! The threaded connection for the pump housing is locked. Work on the electrical section of the pump may only be performed by GARDENA Service.

If you have any other problem, please contact our Customer Service.

7. After Operation

Preparing the battery pump for storage:

To prevent misuse and accidents, the battery must always be stored disconnected from the pump.

1. Take battery pump out of the container and unplug.
2. Charge battery (see **4. Operating**)
3. Store battery and pump in a dry, frost proof location, out of the reach of children.

The battery must be stored charged to increase the life of the battery.

Disposing of the battery:



These Accus contain nickel /cadmium cells. After their lifetime have expired, they may not be disposed of as normal house rubbish, but must be disposed of properly.

- Return batteries to the dealer – **or** – send the batteries direct to one of the service centres listed overleaf.

8. Technical Data

Article	Pump	Accu
Rated power	60 W	
Max. quantity conveyed	1500 l/min (stage 2)	
Max. pressure / delivery head	1.1 bar / 11 m (stage 2)	
Max. submersion depth	1.5 m	
Minimum water depth for operation	ca. 5.5 cm	
Weight	1.3 kg (without telescopic pipe)	0.8 kg
Max. water temperature	35 °C	
Voltage / frequency		12 V (NiCd) / 1.8 Ah
Number of possible charges		Max. 1000 times

9. Service

Warranty

GARDENA guarantees this product for 2 years (from date of purchase).

This guarantee covers all serious defects of the unit that can be proved to be material or manufacturing faults. Under warranty we will either replace the unit or repair it free of charge if the following conditions apply:

- The unit must have been handled properly and in keeping with the requirements of the operating instructions.
- Neither the purchaser or a non-authorised third party have attempted to repair the unit.

The impeller is a wearing part and is not covered by the warranty.

This manufacturer's guarantee does not affect the user's existing warranty claims against the dealer/seller.

If a fault occurs with your Garden Pump, please return the faulty unit together with a copy of the receipt and a description of the fault, with postage paid to one of the GARDENA Service Centres listed on the back of these operating instructions.

<p>D <i>Produkthaftung</i></p>	<p>Wir weisen ausdrücklich darauf hin, dass wir nach dem Produkthaftungsgesetz nicht für durch unsere Geräte hervorgerufene Schäden einzustehen haben, sofern diese durch unsachgemäße Reparatur verursacht oder bei einem Teileaustausch nicht unsere originale GARDENA Teile oder von uns freigegebene Teile verwendet wurden und die Reparatur nicht vom GARDENA Service oder dem autorisierten Fachmann durchgeführt wird. Entsprechendes gilt für Ergänzungsteile und Zubehör.</p>
<p>GB <i>Product Liability</i></p>	<p>We expressly point out that, in accordance with the product liability law, we are not liable for any damage caused by our units if it is due to improper repair or if parts exchanged are not original GARDENA parts or parts approved by us, and, if the repairs were not carried out by a GARDENA Service Centre or an authorised specialist. The same applies to spare parts and accessories.</p>
<p>F <i>Responsabilité</i></p>	<p>Nous vous signalons expressément que GARDENA n'est pas responsable des dommages causés par ses appareils, dans la mesure où ces dommages seraient causés suite à une réparation non conforme, dans la mesure où, lors d'un échange de pièces, les pièces d'origine GARDENA n'auraient pas été utilisées, ou si la réparation n'a pas été effectuée par le Service Après-Vente GARDENA ou l'un des Centres SAV agréés GARDENA. Ceci est également valable pour tout ajout de pièces et d'accessoires autres que ceux préconisés par GARDENA.</p>
<p>NL <i>Productaansprakelijkheid</i></p>	<p>Wij wijzen er nadrukkelijk op, dat wij op grond van de wet aansprakelijkheid voor producten niet aansprakelijk zijn voor schade ontstaan door onze apparaten, indien deze door onvakkundige reparatie veroorzaakt zijn, of er bij het uitwisselen van onderdelen geen gebruik gemaakt werd van onze originele GARDENA onderdelen of door ons vrijgegeven onderdelen en de reparatie niet door de GARDENA technische dienst of de bevoegde vakman uitgevoerd werd. Ditzelfde geldt voor extra-onderdelen en accessoires.</p>
<p>S <i>Produktansvar</i></p>	<p>Tillverkaren är inte ansvarig för skada som orsakats av produkten om skadan beror på att produkten har reparerats felaktigt eller om, vid reparation eller utbyte, andra än Original GARDENA reservdelar har använts. Samma sak gäller för kompletteringsdelar och tillbehör.</p>
<p>I <i>Responsabilità del prodotto</i></p>	<p>Si rende espressamente noto che, conformemente alla legislazione sulla responsabilità del prodotto, non si risponde di danni causati da nostri articoli se originati da riparazioni eseguite non correttamente o da sostituzioni di parti effettuate con materiale non originale GARDENA o comunque da noi non approvato e, in ogni caso, qualora l'intervento non venga eseguito da un centro assistenza GARDENA o da personale specializzato autorizzato. Lo stesso vale per le parti complementari e gli accessori.</p>
<p>E <i>Responsabilidad de productos</i></p>	<p>Advertimos que conforme a la ley de responsabilidad de productos no nos responsabilizamos de daños causados por nuestros aparatos, siempre y cuando dichos daños hayan sido originados por arreglos o reparaciones indebidas, por recambios con piezas que no sean piezas originales GARDENA o bien piezas no autorizadas por nosotros, así como en aquellos casos en que la reparación no haya sido efectuada por un Servicio Técnico GARDENA o por un técnico autorizado. Lo mismo es aplicable para las piezas complementarias y accesorios.</p>
<p>P <i>Responsabilidade sobre o produto</i></p>	<p>Queremos salientar que segundo a lei da responsabilidade do fabricante, nós não nos responsabilizaremos por danos causados pelo nosso equipamento, quando estes ocorrerem em decorrência de reparações inadequadas ou da substituição de peças por peças não originais da GARDENA, ou peças não autorizadas. A responsabilidade tornar-se-à nula também depois de reparações realizadas por oficinas não autorizadas pela GARDENA. Esta restrição valerá também para peças adicionais e acessórios.</p>
<p>DK <i>Produktansvar</i></p>	<p>Vi gør udtrykkeligt opmærksom på at i henhold til produktansvarsloven er vi ikke ansvarlige for skader forårsaget af vores udstyr, hvis det er på grund af uautoriserede reparationer eller hvis dele er skiftet ud og der ikke er anvendt originale GARDENA dele eller dele godkendt af os, eller hvis reparationerne ikke er udført af GARDENA-service eller en autoriseret fagmand. Det samme gælder for ekstra udstyr og tilbehør.</p>

<p>D EU-Konformitätserklärung Maschinenverordnung (9. GSGVO) / EMVG / Niedersp. RL Der Unterzeichnete GARDENA Kress + Kastner GmbH · Hans-Lorenser-Straße 40 · D-89079 Ulm bestätigt, dass die nachfolgend bezeichneten Geräte in der von uns in Verkehr gebrachten Ausführung die Anforderungen der harmonisierten EU-Richtlinien, EU-Sicherheitsstandards und produktspezifischen Standards erfüllen. Bei einer nicht mit uns abgestimmten Änderung der Geräte verliert diese Erklärung ihre Gültigkeit.</p>	Bezeichnung des Gerätes: Accu-Pumpe Description of the unit: Battery Pump Désignation du matériel : Pompe sur accu Omschrijving van het apparaat: Accupomp Produktbeschreibung: Batteridreven pump Descrizione del prodotto: Pompa a batteria Descripción de la mercancía: Bomba con acumulador Descrição do aparelho: Bomba com acumulador Beskrivelse af enhederne: Akku-pumpe
<p>GB EU Certificate of Conformity The undersigned GARDENA Kress + Kastner GmbH · Hans-Lorenser-Str. 40 · D-89079 Ulm hereby certifies that, when leaving our factory, the units indicated below are in accordance with the harmonised EU guidelines, EU standards of safety and product specific standards. This certificate becomes void if the units are modified without our approval.</p>	Typ: Art.-Nr.: Type: Art. No.: Type : Référence : Type: Art. nr.: Typ: 1500/1 Art. nr.: 1498 Modello: Art.: Tipo: Art. Nr.: Tipo: Art. No.: Type: Varenr.:
<p>F Certificat de conformité aux directives européennes Le constructeur, soussigné : GARDENA Kress + Kastner GmbH · Hans-Lorenser-Str. 40 · D-89079 Ulm déclare qu'à la sortie de ses usines le matériel neuf désigné ci-dessous était conforme aux prescriptions des directives européennes énoncées ci-après et conforme aux règles de sécurité et autres règles qui lui sont applicables dans le cadre de l'Union européenne. Toute modification portée sur ce produit sans l'accord express de GARDENA supprime la validité de ce certificat.</p>	EU-Richtlinien: 98/37/EG EU directives: 98/37/EG Directives européennes : 89/336/EG EU-richtlijnen: 89/336/EG EU direktiv: 73/23/EG Direttive UE: 73/23/EG Normativa UE: 93/68/EG Directrices da UE: 93/68/EG EU Retningslinier:
<p>NL EU-overeenstemmingsverklaring Ondergetekende GARDENA Kress + Kastner GmbH · Hans-Lorenser-Str. 40 · D-89079 Ulm bevestigt, dat de volgende genoemde apparaten in de door ons in de handel gebrachte uitvoering voldoen aan de eis van, en in overeenstemming zijn met de EU-richtlijnen, de EU-veiligheidsstandaard en de voor het product specifieke standaard. Bij een niet met ons afgestemde verandering aan de apparaten verliest deze verklaring haar geldigheid.</p>	Anbringningsjahr der CE-Kennzeichnung: Year of CE marking: Date d'apposition du marquage CE : Installatiejaar van de CE-aanduiding: 2003 CE-Mærkningsår: Anno di rilascio della certificazione CE: Colocación del distintivo CE: Ano de marcação pela CE: CE-Mærkningsår:
<p>S EU Tillverkarintyg Undertecknad firma GARDENA Kress + Kastner GmbH · Hans-Lorenser-Straße 40 · D-89079 Ulm intygar härmed att nedan nämnda produkter överensstämmer med EU:s direktiv, EU:s säkerhetsstandard och produktspecifikation. Detta intyg upphör att gälla om produkten ändras utan vårt tillstånd.</p>	
<p>I Dichiarazione di conformità alle norme UE La sottoscritta GARDENA Kress + Kastner GmbH · Hans-Lorenser-Str. 40 · D-89079 Ulm certifica che il prodotto qui di seguito indicato, nei modelli da noi commercializzati, è conforme alle direttive armonizzate UE nonché agli standard di sicurezza e agli standard specifici di prodotto. Qualunque modifica apportata al prodotto senza nostra specifica autorizzazione invalida la presente dichiarazione.</p>	
<p>E Declaración de conformidad de la UE El que suscribe GARDENA Kress + Kastner GmbH · Hans-Lorenser-Str. 40 · D-89079 Ulm declara que la presente mercancía, objeto de la presente declaración, cumple con todas las normas de la UE, en lo que a normas técnicas, de homologación y de seguridad se refiere. En caso de realizar cualquier modificación en la presente mercancía sin nuestra previa autorización, esta declaración pierde su validez.</p>	
<p>P Certificado de conformidade da UE Os abaixo mencionados GARDENA Kress + Kastner GmbH · Hans-Lorenser-Str. 40 · D-89079 Ulm Por este meio certificam que ao sair da fábrica os aparelhos abaixo mencionados estão de acordo com as diretrizes harmonizadas da UE, padrões de segurança e de produtos específicos. Este certificado ficará nulo se as unidades forem modificadas sem a nossa aprovação.</p>	 Thomas Heini Technische Leitung Technical Dept. Manager Direction technique Hoofd technische dienst Technical Director Direzione Tecnica Dirección Técnica Director Técnico Teknisk direktør
<p>DK EU Overensstemmelse certificat Undertegnede GARDENA Kress + Kastner GmbH · Hans-Lorenser-Str. 40 · D-89079 Ulm bekræfter hermed, at enheder listet herunder, ved afsendelse fra fabriken, er i overensstemmelse med harmoniserede EU retningslinier, EU sikkerheds standarder og produkt specifikations standarder. Dette certifikat træder ud af kraft hvis enhederne er ændret uden vor godkendelse.</p>	Ulm, den 11.06.2002 Ulm, 11.06.2002 Fait à Ulm, le 11.06.2002 Ulm, 11-06-2002 Ulm, 2002.06.11 Ulm, 11.06.2002 Ulm, 11.06.2002 Ulm, 11.06.2002 Ulm, 11.06.2002 Ulm, 11.06.2002

Pumpen-Kennlinie:

Performance characteristics

Courbes de performance

Prestatiegrafiek

Kapacitetskurva

Curva di rendimento

Curva característica de la bomba

Características de performance

Ydelses karakteristika

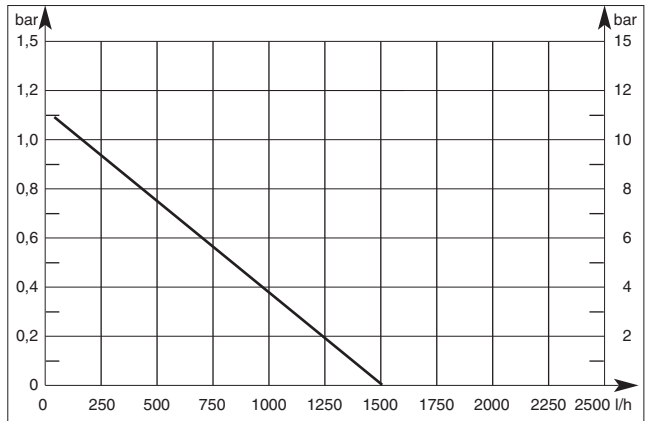

Deutschland

GARDENA Service
Hans-Lorenser-Straße 40
D-89079 Ulm
Produktfragen: (0731) 490-123
Reparaturen: (0731) 490-290

Argentina

Argensem S.A.
Venezuela 1075
(1618) El Talar - Buenos Aires

Australia

NYLEX Corporation Ltd.
25-29 Nepean Highway
P.O. Box 68
Mentone, Victoria 3194

Austria

GARDENA Österreich Ges. m.b.H.
Stettnerweg 11-15
2100 Korneuburg

Belgium

MARKT (Belgium) NV/SA
Sterrebeekstraat 163
1930 Zaventem

Brazil

M. Cassab
Av. das Nações Unidas, 20.882
Santo Amaro, CEP 04795-000
São Paulo - S.P.

Bulgaria / България

ДЕНЕКС ООД
Бул. "Г.М.Димитров" 16 ет.4
София 1797

Canada

GARDENA Canada Ltd.
100, Summerlea Road
Brampton, Ontario
Canada L6T 4X3

Chile

Antonio Martinic Y CIA. LTDA.
Gilberto Fuenzalida 185 Loc.
Las Condes - Santiago de Chile

Costa Rica

Compania Exim
Euroiberoamericana S.A.
350 Sur del Automercado
Los Yoses
San Pedro

Cyprus

FARMOKIPIKI LTD
P.O. Box 7098
74, Digeni Akrita Ave.
1641 Nicosia

Czech Republic

GARDENA spol. s.r.o.
Řípská 20a, č.p. 1153
62700 Brno

Denmark

GARDENA Danmark A/S
Naverland 8
2600 Glostrup

Finland

Habitec Oy
Martinkyläntie 52
01720 Vantaa

France

GARDENA France
Service Après-Vente
BP 50080
95948 ROISSY CDG Cedex

Great Britain

GARDENA UK Ltd.
27-28 Brenkley Way
Bleazard Business Park
Seaton Burn
Newcastle upon Tyne NE13 6DS

Greece

Agrokip G. Psomadopoulos & Co.
20, Lykourgou str.
Kallithea - Athens

Hungary

GARDENA Magyarország Kft.
Késmárk utca 22
1158 Budapest

Iceland

Heimilistaeki hf
Saetun 8
P.O. Box 5340
125 Reykjavik

Republic of Ireland

Michael McLoughlin & Sons
Hardware Limited
Long Mile Road
Dublin 12

Italy

GARDENA Italia S.p.A.
Via Donizetti 22
20020 Lainate (MI)

Japan

KAKUDAI Mfg. Co. Ltd.
1-4-4, Itachibori Nishi-ku
Osaka 550

Luxembourg

Magasins Jules Neuberg
Grand Rue 30
Case Postale No. 12
Luxembourg 2010

Netherlands

GARDENA Nederland B.V.
Postbus 50176
1305 AD ALMERE
Neth. Antilles
Jonka Enterprises N.V.
Sta. Rosa Weg 196
P.O. Box 8200
Curaçao

New Zealand

NYLEX New Zealand Limited
Private Bag 94001
South Auckland Mail Centre
10 Offenhauser Drive
East Tamaki, Manukau

Norway

GARDENA Norge A/S
Postboks 214
2013 Skjetten

Poland

GARDENA Polska Sp. z o.o.
Szymanów 9d
05-532 Baniocza

Portugal

MARKT (Portugal), Lda.
Recta da Granja do Marquês
Edif. GARDENA
Algueirão
2725-596 Mem Martins

Russia / Россия

АО АМИДА ТТЦ
ул. Мосфильмовская 66
117330 Москва

Singapore

Variware
Holland Road Shopping Centre
227-A 1st Fl., Unit 29
Holland Avenue
Singapore 1027

Slovenia / Croatia

Silk d.o.o. Trgovina
Brodišče 15
1236 Trzin

South Africa

GARDENA South Africa (Pty.) Ltd.
P.O. Box 11534
Vorna Valley 1686

Spain

ANMI Andreu y Miriam S.A.
Calle Pere IV, 111
08018 Barcelona

Sweden

GARDENA Svenska AB
Box 9003
20039 Malmö

Switzerland

GARDENA Kress + Kastner AG
Bitziberg 1
8184 Bachenbülach

Ukraine / Украина

АОЗТ АЛЬЦЕСТ
ул. Гайдара 50
г. Киев 01033

Turkey

Dost Diş Ticaret Mümessilik A.Ş.
Yeşilbağlar Mah. Başkent
Cad. No. 26
Pendik - İstanbul

USA

GARDENA
3085 Shawnee Drive
Winchester, VA 22604
1498-01.960.01/0031
© GARDENA Manufacturing GmbH
D-89070 Ulm
<http://www.gardena.com>

Free Manuals Download Website

<http://myh66.com>

<http://usermanuals.us>

<http://www.somanuals.com>

<http://www.4manuals.cc>

<http://www.manual-lib.com>

<http://www.404manual.com>

<http://www.luxmanual.com>

<http://aubethermostatmanual.com>

Golf course search by state

<http://golfingnear.com>

Email search by domain

<http://emailbydomain.com>

Auto manuals search

<http://auto.somanuals.com>

TV manuals search

<http://tv.somanuals.com>