

Instructions



Hotmelt/Warm Melt Heated Hose

309160L
EN

For use with Graco temperature control systems for nonflammable hotmelt and warm melt sealants and adhesives.

WARNING

Fire, Explosion, and Electric Shock Hazard

The operating and safety features of these hoses are designed for use only with Graco temperature control systems. To reduce the risk of serious injury, never connect these hoses to any other device.



Important Safety Instructions

Read all warnings and instructions in this manual.
Save these instructions.



PH00046

PROVEN QUALITY. LEADING TECHNOLOGY.



Table of Contents

List of Models	2
Symbols	3
Warnings	3
Introduction	5
Installation	6
Operation and Maintenance	7
Troubleshooting	8
Technical Data	9
Graco Warranty	10
Graco Information	10

List of Models

Part No.	Length	Hose Core Size	Swivel Fitting	Maximum Fluid Working Pressure @ Temperature	
16J875	10 ft	No. 6 (0.308" ID)	.31 ID (9/16–18 JIC(f))	4000 psi (28 MPa, 276 bar) @ –65°F – 212°F (–54°C – 100°C)	
120556	4 ft	No. 8 (0.401" ID)	.41 ID (3/4–16 JIC(f))		
115902	6 ft	No. 8 (0.401" ID)	.41 ID (3/4–16 JIC(f))		
115873	10 ft	No. 8 (0.401" ID)	.41 ID (3/4–16 JIC(f))		
253281	10 ft	No. 8 (0.401" ID)	.41 ID (3/4–16 JIC(f))		
115874	15 ft	No. 8 (0.401" ID)	.41 ID (3/4–16 JIC(f))		
253282	15 ft	No. 8 (0.401" ID)	.41 ID (3/4–16 JIC(f))		
115875	6 ft	No. 10 (0.495" ID)	.51 ID (7/8–14 JIC(f))		
115876	10 ft	No. 10 (0.495" ID)	.51 ID (7/8–14 JIC(f))		
115877	15 ft	No. 10 (0.495" ID)	.51 ID (7/8–14 JIC(f))		
115878	20 ft	No. 10 (0.495" ID)	.51 ID (7/8–14 JIC(f))		
115879	25 ft	No. 10 (0.495" ID)	.51 ID (7/8–14 JIC(f))		
121200	30 ft	No. 10 (0.495" ID)	.51 ID (7/8–14 JIC(f))		3000 psi (21 MPa, 207 bar) @ 213°F – 400°F (101°C – 204°C)
15C586	3 ft	No. 12 (0.617" ID)	.62 ID (1 1/16–12 JIC(f))		
115903	6 ft	No. 12 (0.617" ID)	.62 ID (1 1/16–12 JIC(f))		
115880	10 ft	No. 12 (0.617" ID)	.62 ID (1 1/16–12 JIC(f))		
115881	15 ft	No. 12 (0.617" ID)	.62 ID (1 1/16–12 JIC(f))		
115882	20 ft	No. 12 (0.617" ID)	.62 ID (1 1/16–12 JIC(f))		
115883	25 ft	No. 12 (0.617" ID)	.62 ID (1 1/16–12 JIC(f))		
115884	6 ft	No. 16 (0.867" ID)	.87 ID (1 5/16–12 JIC(f))		
115885	10 ft	No. 16 (0.867" ID)	.87 ID (1 5/16–12 JIC(f))		
115886	15 ft	No. 16 (0.867" ID)	.87 ID (1 5/16–12 JIC(f))		
115887	20 ft	No. 16 (0.867" ID)	.87 ID (1 5/16–12 JIC(f))	3000 psi (21 MPa, 207 bar) @ –65°F – 400°F (–54°C – 204°C)	
115888	25 ft	No. 16 (0.867" ID)	.87 ID (1 5/16–12 JIC(f))		
117821	10 ft	No. 20 (1.125" ID)	1.13 ID (1 5/8–12 JIC(f))		
117822	15 ft	No. 20 (1.125" ID)	1.13 ID (1 5/8–12 JIC(f))		

Symbols

Warning Symbol







This symbol alerts you to the possibility of serious injury or death if you do not follow the instructions.

Caution Symbol



This symbol alerts you to the possibility of damage to or destruction of equipment if you do not follow the instructions.

 WARNING	
	<p>ELECTRIC SHOCK HAZARD</p> <p>The hoses must be grounded. Improper grounding, set-up or usage of the hoses can cause electric shock.</p> <ul style="list-style-type: none"> • Turn off and disconnect power before installing or servicing hoses. • Connect to grounded power source. • All electrical wiring must be done by a qualified electrician and comply with all local codes and regulations. • Never cut or puncture a hose cover. • Do not expose to rain. Store indoors.
	<p>SKIN INJECTION HAZARD</p> <p>High-pressure fluid from hose leaks, or ruptured components will pierce skin. This may look like just a cut, but it is a serious injury that can result in amputation. Get immediate surgical treatment.</p> <ul style="list-style-type: none"> • Inspect hose before each use for cuts, bulges, kinks or any other damage. • Replace damaged hose immediately. • Replace hoses proactively at regular intervals based on your operating conditions. • Tighten all fluid connections before operating the equipment. • Keep clear of leaks. • Do not stop or deflect leaks with your hand, body, glove, or rag. • Never exceed hose Maximum Pressure or Temperature ratings. • Only use chemicals that are compatible with wetted parts. See Technical Data in this manual. Read MSDSs and fluid and solvent manufacturer's instructions. • Follow the Pressure Relief Procedure when you stop spraying/dispensing and before cleaning, checking, or servicing equipment.
	<p>THERMAL EXPANSION HAZARD</p> <p>Fluids subjected to heat in confined spaces, including hoses, can create a rapid rise in pressure due to the thermal expansion. Over-pressurization can result in equipment rupture and serious injury.</p> <ul style="list-style-type: none"> • Open a valve to relieve the fluid expansion during heating. • Replace hoses proactively at regular intervals based on your operating conditions.
	<p>BURN HAZARD</p> <p>Equipment surfaces and fluid that can cause burns:</p> <ul style="list-style-type: none"> • Do not touch hot fluid or equipment. <p style="text-align: right;">to avoid severe</p>

WARNING



TOXIC FLUID OR FUMES HAZARD

Toxic fluids or fumes can cause serious injury or death if splashed in the eyes or on skin, inhaled, or swallowed.

- Read MSDSs to know the specific hazards of the fluids you are using.
- Store hazardous fluid in approved containers, and dispose of it according to applicable guidelines.
- Always wear chemically impermeable gloves when spraying, dispensing, or cleaning equipment.



FIRE, EXPLOSION, AND ELECTRIC SHOCK HAZARD

Flammable fumes, such as solvent and paint fumes, in work area can ignite or explode. To help prevent fire and explosion:

- Use equipment only in well ventilated area.
- Eliminate all ignition sources; such as pilot lights, cigarettes, portable electric lamps, and plastic drop cloths (potential static arc).
- Keep work area free of debris, including solvent, rags and gasoline.
- Do not plug or unplug power cords, or turn power or light switches on or off when flammable fumes are present.
- Ground all equipment in the work area. See **Grounding** instructions.
- Use only grounded hoses.
- Hold gun firmly to side of grounded pail when triggering into pail.
- If there is static sparking or you feel a shock, **stop operation immediately**. Do not use equipment until you identify and correct the problem.
- Keep a working fire extinguisher in the work area.



EQUIPMENT MISUSE HAZARD

Misuse can cause death or serious injury.

- Do not operate the unit when fatigued or under the influence of drugs or alcohol.
- Do not exceed the maximum working pressure or temperature rating of the lowest rated system component. See **Technical Data** in all equipment manuals.
- Use fluids and solvents that are compatible with equipment wetted parts. See **Technical Data** in all equipment manuals. Read fluid and solvent manufacturer's instructions about your material, request MSDS from distributor or retailer.
- Do not leave the work area while equipment is energized or under pressure. Turn off all equipment and follow the **Pressure Relief Procedure** when equipment is not in use.
- Check equipment daily. Repair or replace worn or damaged parts immediately with genuine manufacturer's parts.
- Do not alter or modify equipment.
- Use equipment only for its intended purpose. Call your distributor for information.
- Route hoses and cables away from traffic areas, sharp edges, moving parts, and hot surfaces.
- Do not kink or over bend hoses or use hoses to pull equipment.
- Keep children and animals away from work area.
- Comply with all applicable safety regulations.



PERSONAL PROTECTIVE EQUIPMENT

You must wear appropriate protective equipment when operating, servicing, or when in the operating area of the equipment to help protect you from serious injury, including eye injury, hearing loss, inhalation of toxic fumes, and burns. This equipment includes but is not limited to:

- Protective eyewear, and hearing protection
- Respirators, protective clothing, and gloves as recommended by the fluid and solvent manufacturer.

Introduction

Each hose assembly must be controlled by a Graco zone controller. The amount of hose used depends on the zone controllers available for control.

The hose has two electrical connectors with cables, each extending from the end of the hose.

The large rectangular connector is the machine end and has 8 foot (2.42 m) of cable (see Fig. 1). The small square connector is the gun end and has 2 foot (0.6 m) of cable (see Fig. 2).



Fig. 1 _____



Fig. 2 _____ PH00051

Connect the machine end connector to the Graco temperature controller by pushing the connector on the mating receptacle of the temperature controller or accessory device and securing the latch.

Connect the gun end connector to any temperature controller accessory device. These include Graco manual and automatic hot melt dispense valves, pressure compensators, manifolds, headers, and pressure regulators.

Installation

⚠ WARNING



THERMAL EXPANSION HAZARD

Fluids subjected to heat in confined spaces, including hoses, and create a rapid rise in pressure due to the thermal expansion. Over-pressurization can result in equipment rupture and serious injury.

- Open a valve to relieve the fluid expansion during heating.
- Replace hoses proactively at regular intervals based on your operating conditions.



⚠ WARNING



SKIN INJECTION HAZARD

To reduce the risk of serious injury, follow the **Pressure Relief Procedure** on page 7 whenever you are instructed to relieve pressure.

NOTE: Pressure check the hose assemblies. Refer to your system operation manual for priming and pressurizing the fluid hoses. Check carefully for leaks at the hose connections. If there are leaks, relieve the pressure as instructed on page 7.

1. Do not use hose to pull the equipment.

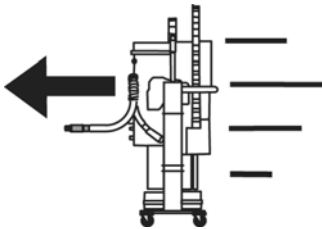

2. Use 2 wrenches to tighten. Torque to specification:



Fitting	Torque, in-lb (N•m)
-4	150 (16.9)
-6	300 (33.9)
-8	500 (56.5)
-10	700 (79.1)
-12	1000 (113.0)
-16	1400 (158.2)
-20	2100 (237.3)
-24	3000 (339.0)

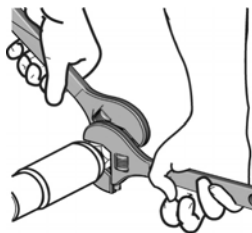

3. Do not tape or cover hose.



4. Do not flex hose when cold.

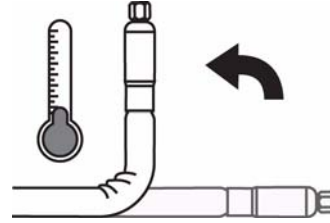

5. Use hose support spring.



6. Do not clamp, squeeze, or zip tie hose.

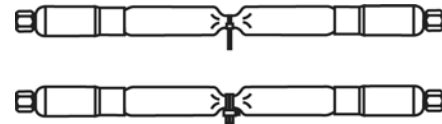

7. Minimum bend radius:.



Fitting	Radius
-4	8 in. (203 mm)
-6	8 (203)
-8	10 (254)
-10	12 (305)
-12	14 (356)
-16	18 (457)
-20	22 (559)
-24	26 (660)

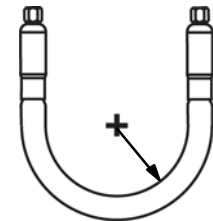

8. Do not bend or crimp hose.

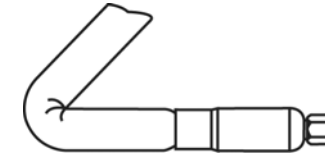

9. Do not twist hose.



10. Use proper length hose.

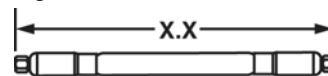

Operation and Maintenance

Pressure Relief Procedure

WARNING

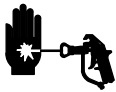

SKIN INJECTION HAZARD

The system pressure must be manually relieved to prevent the system from starting or dispensing accidentally. Fluid under high pressure can be injected through the skin and cause serious injury. To reduce the risk of an injury from injection, splashing fluid, or moving parts, follow the **Pressure Relief Procedure** whenever you:

- are instructed to relieve the pressure,
- stop dispensing,
- check or service any of the system equipment,
- or install a new or clean the dispense gun tip/nozzle.

1. Lock the gun trigger safety.
2. Shut off the air to the supply pumps.
3. Turn off the power (air) to the proportioning pump.
4. Unlock the spray gun trigger safety.
5. Hold a metal part of the gun firmly to the side of a grounded metal pail, then trigger the gun to relieve pressure.
6. Lock the trigger safety again.
7. *If you suspect that the dispense valve or hose is completely clogged, or that pressure has not been fully relieved after following the steps above, very slowly* loosen the tip retaining nut or hose end coupling to relieve pressure gradually, then loosen completely. Wear protective gloves to avoid skin injection or burns. Now clear the tip/nozzle or hose.
8. Be sure the fluid is cool before disconnecting the hoses.

Operation

WARNING

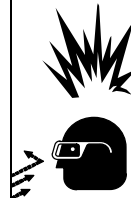

This equipment should not be used with more than one type of fluid due to potential compatibility issues which could result in an unpredictable reaction. Graco recommends using new hoses when chemicals are changed or care must be taken to assure that all traces of one chemical are removed before introducing a second chemical.

CAUTION

- Do not pressurize hose until operating temperature has been reached.
- Operate at lowest possible temperature and pressure necessary for application.
- Hose must be vented during startup and shut-down.
- The dispense valve must be kept open over a waste container while the system is heating up and also when cooling down. This will prevent a pressure build-up caused by fluids or gasses expanding from the heat.

Refer to your system operation manual for complete startup and operating instructions.

Maintenance

WARNING

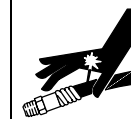

SKIN INJECTION HAZARD

Do not mend or repair any part of a hose assembly. If the hose is damaged, replace it immediately to avoid serious injury from fluid injection and electric shock.

If the hose is not heating, be sure the connector at the hose control box is firmly plugged in. If that does not correct the problem, relieve the fluid pressure in the pump and hoses, as instructed at left. If the hose is faulty or the problem not corrected, replace the hose. See Troubleshooting on page 8 for electrical measurements.

Troubleshooting

9. Check the continuity of the hose components.

Approximate RTD resistance values at various temperatures.

- a. Use an ohmmeter to check the electrical resistance at the heating element pins between pins A1 and A2 of the machine end connector (A) that attaches to the heated hose control. See Fig.1. The resistance of the heating element for the various lengths of coupled hose assemblies is given in the following coupled hose chart.

Length/ft	Pins A1 & A2 Resistance Values (ohms) at 230 VAC	
6	176	+/- 18
10	106	+/- 11
15	71	+/- 7
20	53	+/- 5
25	42	+/- 4

Any resistance reading outside the range may indicate a faulty hose

The resistance values of the RTD will vary with temperature. An approximation of hose temperature must be made to verify the resistance reading of the RTD across pin A4 and A5 is correct.

- b. Between pin A4 and A5 of the large machine end connector, the RTD resistance must be within the range of the following chart.

Temperature		Pins A4 & A5 Approximate Resistance Values (ohms)
C	F	
16	60	106
27	80	110
38	100	115
49	120	119
60	140	123
71	160	128
82	180	132
93	200	136
104	220	140
116	240	144
127	260	149
138	280	153
149	300	160
160	320	161
171	340	165
182	360	170
193	380	174
204	400	177

10. **Check all hose connections** to be sure they are securely tightened.

11. **Ground the system.**

Troubleshooting

Make sure there is electrical continuity ($<10\Omega$) between the following pins of the large machine end connector and the small gun end connector

Lack of electrical continuity between any of these pins is a failure of the hose. Replace the hose assembly.

Continuity Between Connectors	
Machine End	Gun End
B1	1
B2	2
B3	5
B4	3
B5	4
C1	6
C2	7
GND	GND

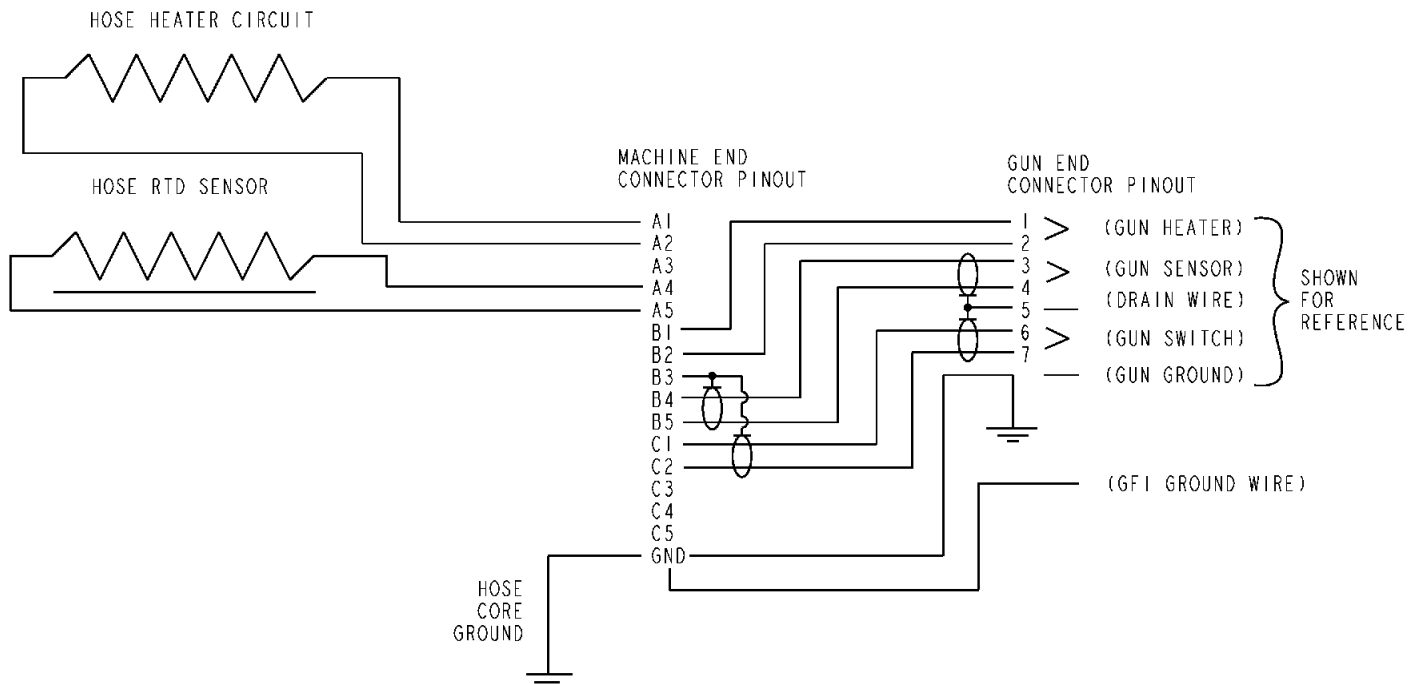

Fig. 3

Technical Data

Maximum fluid working pressure	See table on page 2
Maximum working temperature	See table on page 2
Hose fluid fittings	See table on page 2
Power required	230 VAC, 50/60 Hz
Wetted parts	PTFE core, SST couplings
Power consumption	50 \pm 3 watts/linear foot of hose (164 \pm 10 watts/linear meter of hose)
Minimum Bend Radius	Hose with No. 6 – No. 16 core = 8 in. (20 cm) Hose with No. 20 core = 12 in. (30 cm)

Graco Standard Warranty

Graco warrants all equipment manufactured by Graco and bearing its name to be free from defects in material and workmanship on the date of sale to the original purchaser for use. With the exception of any special, extended, or limited warranty published by Graco, Graco will, for a period of twelve months from the date of sale, repair or replace any part of the equipment determined by Graco to be defective. This warranty applies only when the equipment is installed, operated and maintained in accordance with Graco's written recommendations.

This warranty does not cover, and Graco shall not be liable for general wear and tear, or any malfunction, damage or wear caused by faulty installation, misapplication, abrasion, corrosion, inadequate or improper maintenance, negligence, accident, tampering, or substitution of non-Graco component parts. Nor shall Graco be liable for malfunction, damage or wear caused by the incompatibility of Graco equipment with structures, accessories, equipment or materials not supplied by Graco, or the improper design, manufacture, installation, operation or maintenance of structures, accessories, equipment or materials not supplied by Graco.

This warranty is conditioned upon the prepaid return of the equipment claimed to be defective to an authorized Graco distributor for verification of the claimed defect. If the claimed defect is verified, Graco will repair or replace free of charge any defective parts. The equipment will be returned to the original purchaser transportation prepaid. If inspection of the equipment does not disclose any defect in material or workmanship, repairs will be made at a reasonable charge, which charges may include the costs of parts, labor, and transportation.

THIS WARRANTY IS EXCLUSIVE, AND IS IN LIEU OF ANY OTHER WARRANTIES, EXPRESS OR IMPLIED, INCLUDING BUT NOT LIMITED TO WARRANTY OF MERCHANTABILITY OR WARRANTY OF FITNESS FOR A PARTICULAR PURPOSE.

Graco's sole obligation and buyer's sole remedy for any breach of warranty shall be as set forth above. The buyer agrees that no other remedy (including, but not limited to, incidental or consequential damages for lost profits, lost sales, injury to person or property, or any other incidental or consequential loss) shall be available. Any action for breach of warranty must be brought within two (2) years of the date of sale.

Graco makes no warranty, and disclaims all implied warranties of merchantability and fitness for a particular purpose in connection with accessories, equipment, materials or components sold but not manufactured by Graco. These items sold, but not manufactured by Graco (such as electric motors, switches, hose, etc.), are subject to the warranty, if any, of their manufacturer. Graco will provide purchaser with reasonable assistance in making any claim for breach of these warranties.

In no event will Graco be liable for indirect, incidental, special or consequential damages resulting from Graco supplying equipment hereunder, or the furnishing, performance, or use of any products or other goods sold hereto, whether due to a breach of contract, breach of warranty, the negligence of Graco, or otherwise.

FOR GRACO CANADA CUSTOMERS

The parties acknowledge that they have required that the present document, as well as all documents, notices and legal proceedings entered into, given or instituted pursuant hereto or relating directly or indirectly hereto, be drawn up in English. Les parties reconnaissent avoir convenu que la rédaction du présente document sera en Anglais, ainsi que tous documents, avis et procédures judiciaires exécutés, donnés ou intentés à la suite de ou en rapport, directement ou indirectement, avec les procédures concernées.

Graco Information

For the latest information about Graco products, visit www.graco.com.

TO PLACE AN ORDER, contact your Graco distributor or call to identify the distributor closest to you:

Phone: 612-623-6921 or **Toll Free:** 1-800-328-0211 **Fax:** 612-378-3505

All written and visual data contained in this document reflects the latest product information available at the time of publication.

Graco reserves the right to make changes at any time without notice.

For patent information, see www.graco.com/patents.

Original instructions. This manual contains English. MM 309160

Graco Headquarters: Minneapolis

International Offices: Belgium, China, Japan, Korea

GRACO INC. AND SUBSIDIARIES • P.O. BOX 1441 • MINNEAPOLIS MN 55440-1441 • USA

Copyright 2000, Graco Inc. All Graco manufacturing locations are registered to ISO 9001.

www.graco.com

Revised December 2012

Free Manuals Download Website

<http://myh66.com>

<http://usermanuals.us>

<http://www.somanuals.com>

<http://www.4manuals.cc>

<http://www.manual-lib.com>

<http://www.404manual.com>

<http://www.luxmanual.com>

<http://aubethermostatmanual.com>

Golf course search by state

<http://golfingnear.com>

Email search by domain

<http://emailbydomain.com>

Auto manuals search

<http://auto.somanuals.com>

TV manuals search

<http://tv.somanuals.com>