

Seal Kits

312071D

ENG

To replace proportioning pump piston seal sets or cylinder seal sets used on Hydraulic Proportioners.



Important Safety Instructions

For complete instructions and warnings see manual 312068. Read all warnings and instructions in this manual and manual 312068. Save both sets of instructions.

FIG. 1: Piston Seal Kits

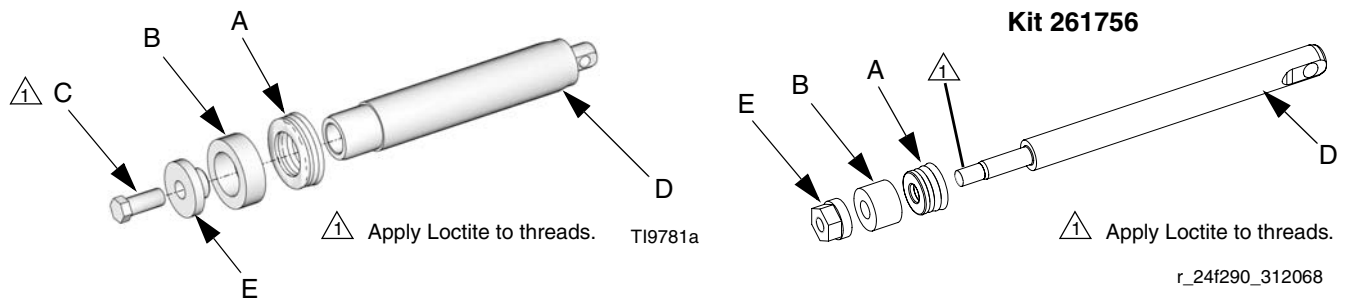
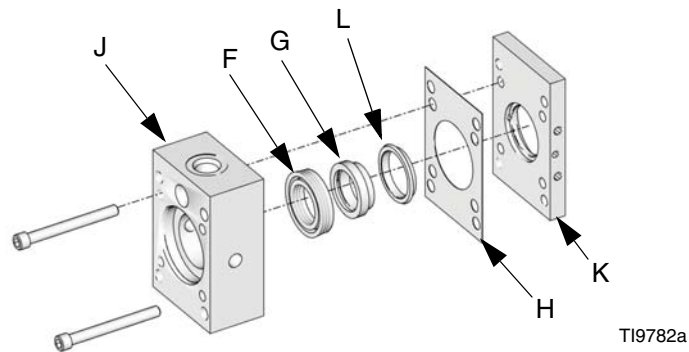







FIG. 2: Cylinder Seal Kits



 Parts with a check mark (✓) in the following tables are included in the kits.

						
Before beginning, follow the Pressure Relief Procedure in proportioning pump manual 312068.						

Piston Seal Kits

See FIG. 1 for piston seal locations.

Pump	Pump Size	Kit	A (Piston Seal)	B (Bushing)	C (Bolt)	D (Piston Rod)	E (Piston Cap)
24F291	28	261756	✓	✓		16F202	16F204
247371	30	261851	✓	✓	✓	261882	261889
247372	40	261850	✓	✓	✓	261881	261886
247373	48	261849	✓	✓	✓	261880	261886
247374	60	261848	✓	✓	✓	261879	261886
247375	80	261847	✓	✓	✓	261878	261883
247577	88	247578	✓	✓	✓	247584	261883
247376	96	261846	✓	✓	✓	261877	261883
247377	120	261845	✓	✓	✓	261876	261883
247576	140	247579	✓	✓	✓	247585	261883

Cylinder Seal Kits

See FIG. 2 for cylinder seal locations.

Pump	Proportioning Pump Size	Kit	F (Cylinder Seal)	G (Bearing)	H (Gasket)	J (Outlet Flange)	K (Retainer Flange)	L (Adapter Ring)
24F291	28	261858	✓	✓	✓	261902	261875	261874
247371	30	261858	✓	✓	✓	261902	261875	261874
247372	40	261857	✓	✓	✓	261902	261875	261873
247373	48	261856	✓	✓	✓	261902	261875	261872
247374	60	261855	✓	✓	✓	261902	261875	261871
247375	80	261854	✓	✓	✓	261901	261875	261870
247577	88	247580	✓	✓	✓	261901	261875	247586
247376	96	261853	✓	✓	✓	261901	261875	261869
247377	120	261852	✓	✓	✓	261901	261875	261868
247576	140	247581	✓	✓	✓	261901	261875	247587

All written and visual data contained in this document reflects the latest product information available at the time of publication. Graco reserves the right to make changes at any time without notice.

Original instructions. This manual contains English. MM 312071

Graco Headquarters: Minneapolis
International Offices: Belgium, China, Japan, Korea

GRACO INC. P.O. BOX 1441 MINNEAPOLIS, MN 55440-1441

Copyright 2007, Graco Inc. is registered to ISO 9001

www.graco.com

Revised 07/2010

Download from Www.Softmanuals.com. All Manuals Search And Download.

Free Manuals Download Website

<http://myh66.com>

<http://usermanuals.us>

<http://www.somanuals.com>

<http://www.4manuals.cc>

<http://www.manual-lib.com>

<http://www.404manual.com>

<http://www.luxmanual.com>

<http://aubethermostatmanual.com>

Golf course search by state

<http://golfingnear.com>

Email search by domain

<http://emailbydomain.com>

Auto manuals search

<http://auto.somanuals.com>

TV manuals search

<http://tv.somanuals.com>