

24P822 E-Flo® DC Control

Module Kit

3A2527E
EN

User Interface for E-Flo® DC Pumps with an Advanced Motor.
For professional use only.



Important Safety Instructions

Read all warnings and instructions in this manual, the supplied ADCM manual, and the E-Flo DC manuals.

Save these instructions.

*See the separate manual (supplied)
for complete warnings and approvals
information about the 24L097 Advanced
Display Control Module (ADCM).*

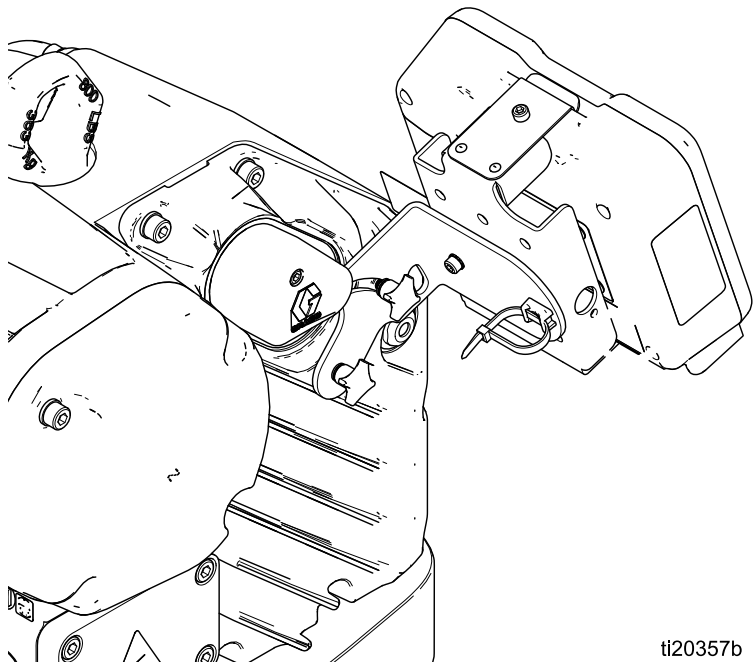

ti20357b

PROVEN QUALITY. LEADING TECHNOLOGY.

Contents

Control Module	3	Setup Screen 1	16
Installation.....	3	Setup Screen 2.....	18
Install the Control Module	3	Setup Screen 3.....	19
Install Optional Accessory Kits	4	Setup Screen 4.....	20
Cable Connection	5	Setup Screen 5.....	22
Operation.....	6	Setup Screen 6.....	23
Module Screens.....	6	Setup Screen 7.....	23
Module Keys.....	6	Setup Screens 8 and 9.....	24
Icons.....	8	Setup Screens 10 and 11	25
Screen Navigation and Editing	9	Setup Screen 12.....	26
Initial Setup	9	Setup Screen 13.....	27
Screen Map.....	10	Setup Screen 14.....	28
Run Screens	12	Setup Screen 15.....	29
Run Screen 1	12	Error Code Troubleshooting	30
Run Screen 2	13	Parts.....	32
Run Screen 3	13	24P822 Control Module Kit	32
Run Screen 4	14	Appendix A - Modbus Variable Map	34
Run Screens 5–8	14	Appendix B. Pump Control from a PLC	38
Setup Screens.....	16	Graco Standard Warranty.....	40

Control Module

The Control Module provides the interface for users to enter selections and view information related to setup and operation.

The screen backlight is factory set to remain on, even without screen activity. See **Setup Screen 4** to set the backlight timer to your preference. Press any key to restore.

Keys are used to input numerical data, enter setup screens, navigate within a screen, scroll through screens, and select setup values.

4. Install the module (1) in the bracket (6a), making sure the tabs at the bottom of the bracket engage the slots in the module, and the lip at the top of the bracket holds the module securely in place.
5. Connect the accessory cable (C), using the tie (12) as a strain relief as shown. See [Cable Connection, page 5](#).
6. Restore power to the motor.

Installation

Install the Control Module

1. Shut off and lock out power to the motor.
2. Install the jumper connector (5) over the top two terminals of the motor, using the screw (5a).

NOTE: To connect up to 8 motors together, see Appendix A in the E-Flo DC Motor Manual, where the control module is the referenced intrinsically safe (IS) apparatus.

3. Assemble the bracket kit (6a-6f) and the holder and tie (11, 12) as shown.

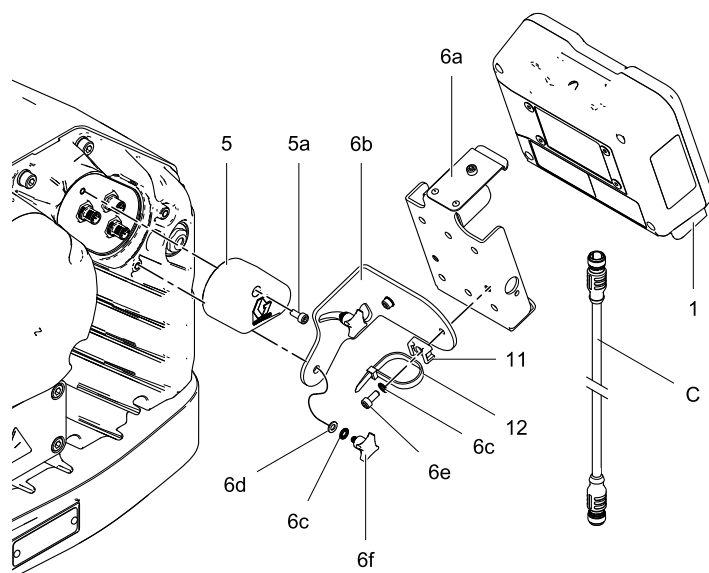

ti20137b

Figure 1 Install the Control Module

Install Optional Accessory Kits

Optional accessory kits are available for purchase separately, including a pressure transducer kit (PN 24R050 for 4–ball pumps; PN 24Y245 for 2–ball pumps), a start/stop switch kit (PN 16U729), and a controller kit (24V001) for a back pressure regulator.

Pressure Transducer Kit

1. To measure fluid pressure, install the pressure transducer in the fluid line with a tee fitting.

Option	Description
Closed Loop Control Enabled	If closed loop control is enabled on Setup Screen 8 (transducer 1) or Setup Screen 9 (transducer 2), install the transducer near the pump outlet, not near the end of the circulation line.
Closed Loop Control Not Enabled	Install the transducer where needed.

2. Connect the transducer cable to Port 7 (transducer 1) or Port 10 (transducer 2) on the control module.

Start/Stop Switch Kit

1. Mount the switch near the control module, using the bracket provided.
2. Connect the switch cable to Port 4 on the control module.

BPR Controller

The BPR (back pressure regulator) controller enables the user to control the back fluid pressure from the control module.

1. Mount the BPR controller using the bracket provided.
2. Connect a supply air line to the BPR controller air inlet (105).

NOTICE

To prevent equipment damage, always apply air pressure to the BPR controller before applying power to the system.

3. Connect an air line from the BPR controller air output (108) to the BPR.
4. Connect the BPR controller input cable (102) to Port 8 on the control module.

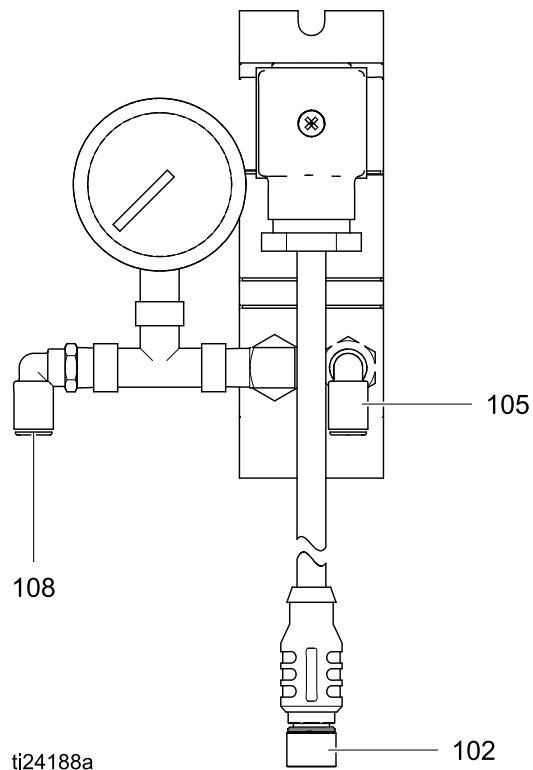

Cable Connection

Order an accessory cable (C) from Table 1. Connect the cable to Port 3 on the bottom of the control module (see Fig. 2). Connect the other end to the power terminal (PT) on the motor (see Fig. 3). Connect other cables as described in Table 2.

Table 1 CAN Cables

Cable Part No.	Description
16P911	Intrinsically safe CAN cable, female x female, 3 ft (1 m)
16P912	Intrinsically safe CAN cable, female x female, 25 ft (8 m)

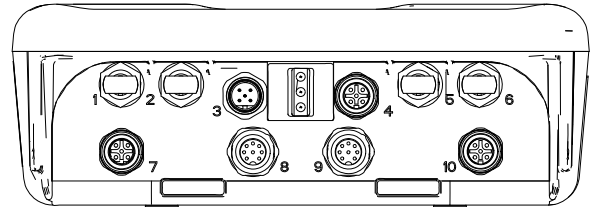

ti19093a

Figure 2 ADCM Connectors

Table 2 ADCM Cable Connections

ADCM Port Number	Connector Purpose
1	Fiber Optic RX - to PLC
2	Fiber Optic TX - to PLC
3	Power and CAN communication
4	Start/stop input
5	Fiber Optic RX - to next ADCM
6	Fiber Optic TX - to next ADCM
7	Pressure transducer 1
8	BPR control 4-20mA output
9	Not used
10	Pressure transducer 2

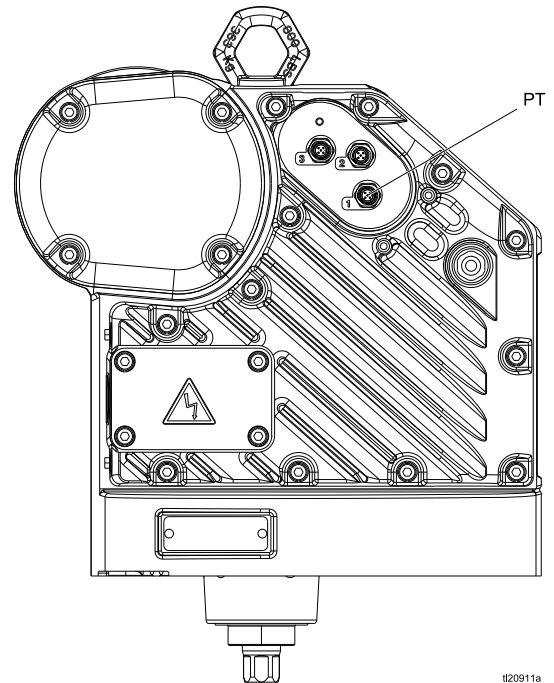

ti20911a

Figure 3 Motor Power Terminal

Operation

Module Screens

The Control Module has two sets of screens: Run and Setup. For detailed information see [Run Screens, page 12](#), and [Setup Screens, page 16](#).

Press  to toggle between the Run screens and the Setup screens.

Module Keys

Fig. 4 is a view of the control module display and keys. Table 2 explains the function of the membrane keys on the control module. As you move through the screens, you will notice that most information is communicated using icons rather than words to simplify global communication. The detailed screen descriptions in [Run Screens, page 12](#), and [Setup Screens, page 16](#), explain what each icon represents. The two softkeys are membrane buttons whose function correlates with the screen content to the immediate left of the button.

NOTICE



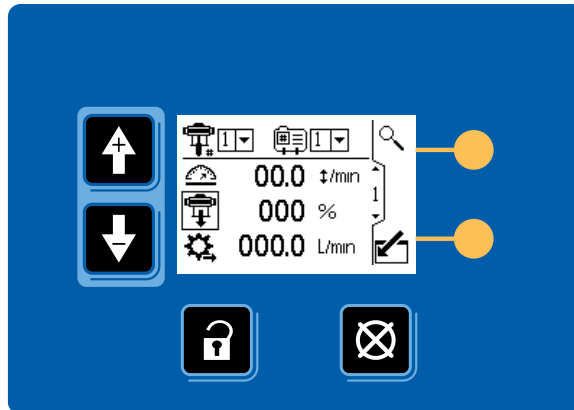







To prevent damage to the softkey buttons, do not press the buttons with sharp objects such as pens, plastic cards, or fingernails.



ii19866b

Figure 4 Control Module Keypad and Display

Table 3 Module Keys

Membrane Keys	Softkeys
 <p>Press to toggle between Run screens and Setup screens.</p>	 <p><i>Enter Screen.</i> Highlight data that can be edited. Also changes the function of the Up/Down arrows so they move between data fields on the screen, rather than between screens.</p>
 <p><i>Error Reset:</i> Use to clear alarm after cause has been fixed. When there is no alarm to clear, this key will set the active pump's profile to Stop. Also used to cancel data entered and return to original data.</p>	 <p><i>Exit Screen.</i> Exit data editing.</p>
 <p><i>Up/Down Arrows:</i> Use to move between screens or fields on a screen, or to increment or decrement the digits in a settable field.</p>	 <p><i>Enter.</i> Press to activate a field for editing or to accept the highlighted selection on a dropdown menu.</p>
 <p><i>Softkeys:</i> Use varies by screen. See columns at right.</p>	 <p><i>Right.</i> Move to the right when editing number fields. Press again to accept the entry when all digits are correct.</p>
	 <p><i>Reset.</i> Reset totalizer to zero.</p>
	 <p><i>Activate Profile.</i> This softkey is disabled by default, and only appears if the "Profile Lock" box is checked on Setup Screen 15, page 29. Press to activate the profile just edited.</p>
	 <p><i>Search.</i> Press in Run Screen 1 to make the active pump blink for identification.</p>

Icons

As you move through the screens, you will notice that most information is communicated using icons rather than words to simplify global communication. The detailed screen descriptions in [Run Screens, page 12](#), and [Setup Screens, page 16](#), explain what each icon represents.







Screen Icons	
	Pump Number
	Speed
	Pump Pressure
	Pressure
	In Setup Mode
	Pressure Mode
	Lower Size
	Maximum Limit
	Maximum and Minimum Limits
	Alarm Enable
	Profile Number
	Cycles
	Flow Rate
	Target
	Mode Select
	Flow Mode
	Back Pressure Regulator
	Minimum Limit
	Deviation Enable

Screen Icons	
	Jog Mode
	Jog Up/Down
	Cycles Total
	Volume
	Maintenance
	Transducer
	Pressure Transducer Off
	Calibration Scale
	Zero Offset
	Serial Number
	Control Location
	Local Control
	PLC/Remote Control
	Modbus Device
	Modbus Address
	Serial Port
	Serial Baudrate
	Calendar
	Clock
	Password
	Lock Profile





Screen Navigation and Editing

Refer to this section if you have questions about screen navigation or about how to enter information and make selections.





All Screens

1. Use   to move between screens.
2. Press  to enter a screen. The first data field on the screen will highlight.
3. Use   to highlight the data you wish to change.
4. Press  to edit.

Drop Down Field



1. Use   to highlight the correct choice from the dropdown menu.
2. Press  to select.
3. Press  to cancel.

Number Field

1. The first digit will be highlighted. Use   to change the number.
2. Press  to move to the next digit.
3. When all digits are correct, press  again to accept.
4. Press  to cancel.

Check Box Field



A check box field is used to enable or disable features in the software.

1. Press  to toggle between  and an empty box.
2. The feature is enabled if a  is in the box.

Reset Field

The reset field is used for totalizers. Press  to reset the field to zero.

When all data is correct, press  to exit the screen.

Then use   to move to a new screen, or  to move between Setup screens and Run screens.

Initial Setup

NOTE: Before creating the pump profiles in Setup Screens 1 through 4, you must set up the system parameters in Setup Screens 5 through 15, as follows.



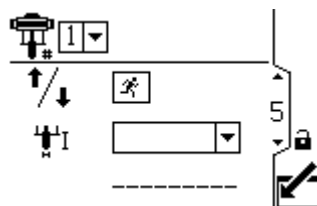



1. Press  to enter the Setup screens. Setup Screen 1 will appear.
2. Scroll to Setup Screen 5.

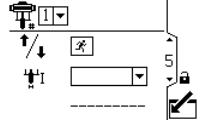
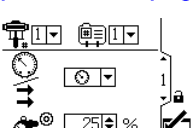
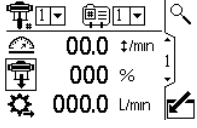
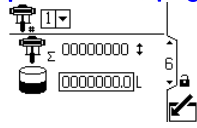
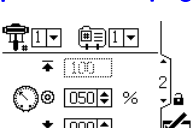
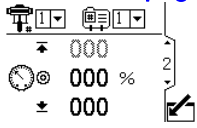
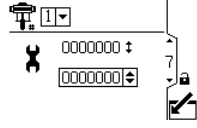
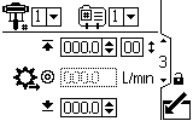
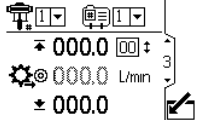
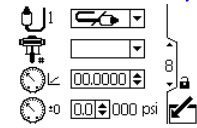
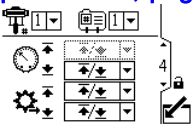
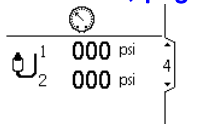
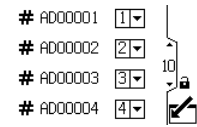
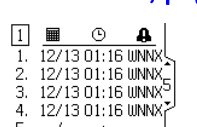

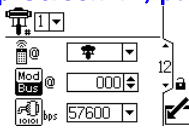
3. See [Setup Screen 5, page 22](#), and select the lower used in your system.
4. Continue setting the system parameters on [Setup Screen 6, page 23](#) through [Setup Screen 15, page 29](#).
5. Scroll to Setup Screen 1. Establish the profiles for each pump. See [Setup Screen 1, page 16](#) through [Setup Screen 4, page 20](#).

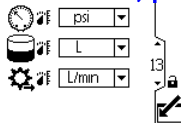
Screen Map

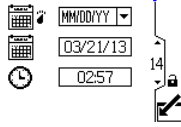
INITIAL SETUP (Setup Screens 5–14)	SETUP AND EDIT PROFILES (Setup Screens 1–4)	RUN (Run Screens 1–8)
<p>Setup Screen 5, page 22</p> 	<p>Setup Screen 1, page 16</p> 	<p>Run Screen 1, page 12</p> 
▼	▼	▼
<p>Setup Screen 6, page 23</p> 	<p>Setup Screen 2, page 18</p> 	<p>Run Screen 2, page 13</p> 
▼	▼	▼
<p>Setup Screen 7, page 23</p> 	<p>Setup Screen 3, page 19</p> 	<p>Run Screen 3, page 13</p> 
▼	▼	▼
<p>Setup Screens 8 and 9, page 24</p> 	<p>Setup Screen 4, page 20</p> 	<p>Run Screen 4, page 14</p> 
▼		▼
<p>Setup Screens 10 and 11, page 25</p> 		<p>Run Screens 5–8, page 14</p> 
▼		
<p>CONTINUED ON THE NEXT PAGE.</p>		

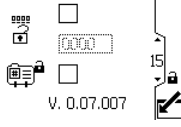
INITIAL SETUP (Setup Screens 5–14)	SETUP AND EDIT PROFILES (Setup Screens 1–4)	RUN (Run Screens 1–8)
<p>Setup Screen 12, page 26</p> 		
		
<p>Setup Screen 13, page 27</p> 		
		
<p>Setup Screen 14, page 28</p> 		
		
<p>Setup Screen 15, page 29</p> 		

Run Screens

The Run screens display current target values and performance for a selected pump and profile. Any alarms will display in the sidebar at the right of the screen. Screens 5–8 display a log of the last 20 alarms for the active pump.

Information displayed on the Run screens corresponds to the Modbus Registers. See [Appendix A - Modbus Variable Map, page 34](#).

The active pump and profile may be changed in Run Screens 1, 2, and 3.

Run Screen 1

This screen displays information for a selected pump and profile. A box around an icon indicates which mode the active pump and profile is running (pressure or flow).

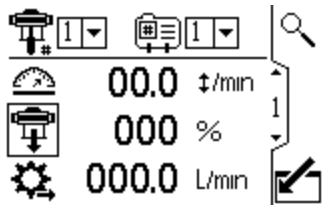

Figure 5 Run Screen 1

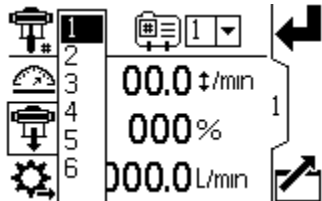

Figure 6 Select a Pump

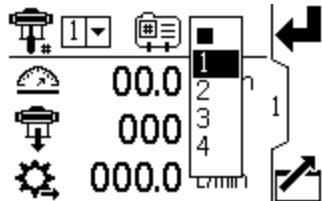

Figure 7 Select a Profile

Run Screen 1 Key	
	Enter the screen.
	For systems with multiple pumps and one display, select the desired pump (1 to 8), using the pull-down menu.
	Select the desired profile (1 to 4), using the pull-down menu.
	Select from the profile drop-down menu to stop the pump.
	Displays current pump speed in cycles per minute.
	Displays current pump pressure as a percentage. If a transducer is used, this icon is replaced by the pressure icon.
	Displays current flow rate, in units as selected in Setup Screen 13, page 27 .
	Exit the screen.
	Signals the active pump to blink code 9 for identification.

Run Screen 2

This screen displays pressure settings for the active pump and profile.

NOTE: Some fields are grayed out, depending on setup selections.

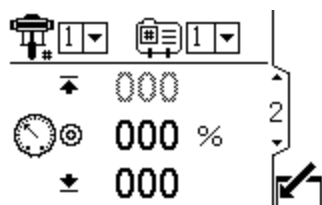

Figure 8 Run Screen 2, in Pressure Mode

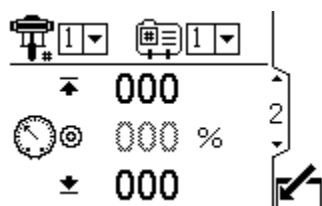

Figure 9 Run Screen 2, in Flow Mode

Run Screen 3

This screen displays fluid flow settings for the active pump and profile.

NOTE: Some fields are grayed out, depending on setup selections.

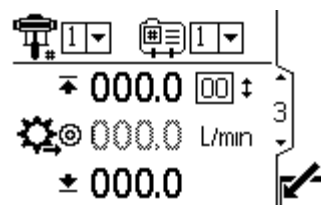

Figure 10 Run Screen 3, in Pressure Mode

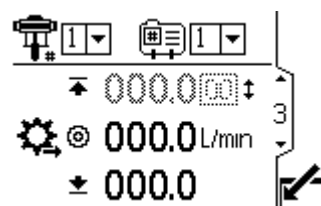

Figure 11 Run Screen 3, in Flow Mode

Run Screen 2 Key	
	Enter the screen.
	For systems with multiple pumps and one display, select the desired pump (1 to 8), using the pull-down menu.
	Select the desired profile (1 to 4), using the pull-down menu.
	Select from the profile drop-down menu to stop the pump.
	Displays pressure maximum (first data field), target (second data field), and minimum (third data field), as selected in Setup Screen 2, page 18 . See Setup Screen 4, page 20 to set or disable the pressure alarms.
	Exit the screen.

Run Screen 3 Key	
	Enter the screen.
	For systems with multiple pumps and one display, select the desired pump (1 to 8), using the pull-down menu.
	Select the desired profile (1 to 4), using the pull-down menu.
	Select from the profile drop-down menu to stop the pump.
	The first line displays the maximum flow rate and maximum cycle rate (displayed as a cpm conversion of the maximum flow setting). The second line displays the target flow rate. The third line displays the minimum flow rate. See Setup Screen 3, page 19 to establish these settings. See Setup Screen 4, page 20 to set or disable the flow alarms.
	Exit the screen.

Run Screen 4

This screen displays the current pressure readings of transducers 1 and 2. Pressure can be displayed as psi, bar, or MPa. See [Setup Screen 13, page 27](#).

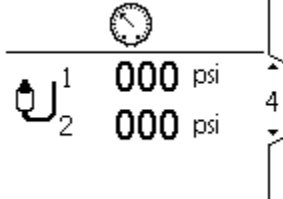

Figure 12 Run Screen 4

Run Screens 5–8

Run Screens 5–8 display a log of the last 20 alarms, with date and time. The currently active pump is displayed in a box at the top left of the screen.

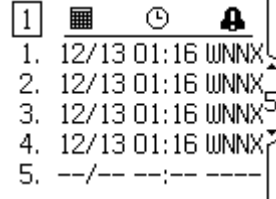

Figure 13 Run Screens 5–8 (Screen 5 shown)

Setup Screens

Use the Setup screens to set control parameters for the motor. See [Screen Navigation and Editing, page 9](#), for information on how to make selections and enter data.

Inactive fields are grayed-out on a screen.

Information displayed on the Setup screens corresponds to the Modbus Registers. See [Appendix A - Modbus Variable Map, page 34](#).

NOTE: Before setting up profiles on Setup Screens 1–4, do the initial setup on Setup Screens 5–15. Screens 5–15 establish the configuration for your system and affect the displayed data.

Setup Screen 1

Use this screen to set the operating mode for a selected pump and profile.

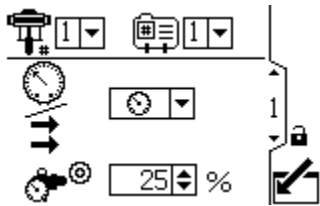

Figure 14 Setup Screen 1

Setup Screen 1 Key	
	Enter the screen.
	Pump selection — See Step 1.
	Profile selection — See Step 2.
	Pressure mode or Flow mode — See Step 3
	Setting for Back Pressure Regulator — See Step 4.
	Press to accept the selections.
	This softkey is disabled by default, and only appears if the “Profile Lock” box is checked on Setup Screen 15, page 29 . Press to activate the profile just edited.
	Exit the screen.

- For systems with multiple pumps and one display, select the desired pump (1 to 8), using the pull-down menu.

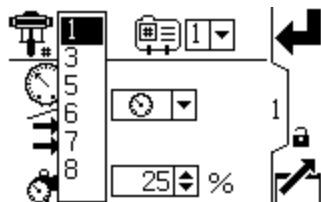

Figure 15 Select Pump Number

- Select the desired profile (1 to 4), using the pull-down menu.

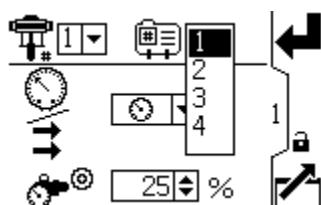

Figure 16 Select Profile Number

- Select the desired operating mode (pressure or flow), using the pull-down menu.

- In pressure mode**, the motor will adjust the pump speed to maintain the fluid pressure percentage set on Setup Screen 2. If the flow limit is reached before the target pressure, the unit will stop driving to the pressure (if set as an alarm).

- In flow mode**, the motor will maintain a constant speed to maintain the target flow rate set on Setup Screen 3, regardless of the fluid pressure, up to the pump's maximum working pressure.

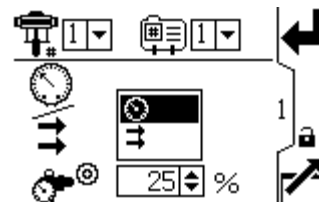

Figure 17 Select Mode (Pressure Mode Shown)

- If the system is equipped with a back pressure regulator (BPR), set the target air pressure to the BPR from 0 to 100 percent (approximately 1 to 100 psi). Leave the field set to 000 for a system with no BPR. See manual 332142 for information on the BPR control kit.

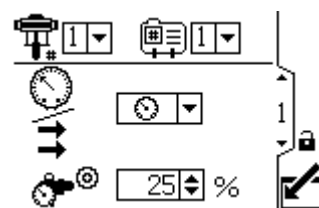











Figure 18 Set Back Pressure Regulator

Setup Screen 2

Use this screen to set the maximum, target, and minimum fluid pressure for a selected pump and profile. In pressure mode, you will set a target fluid pressure. In flow mode, you will set a maximum fluid pressure. In either pressure or flow mode, a minimum pressure may be set if desired. See [Setup Screen 4, page 20](#), to specify how the system will respond if the pump begins to operate outside of the set boundaries.

Setup Screen 2 Key	
	Enter the screen.
	Pump selection — See Step 1.
	Profile selection — See Step 2.
	Fluid pressure maximum— See Step 3.
	Fluid pressure target — See Step 4.
	Fluid pressure minimum — See Step 5.
	Press to accept the selections.
	This softkey is disabled by default, and only appears if the “Profile Lock” box is checked on Setup Screen 15, page 29 . Press to activate the profile just edited.
	Exit the screen.

1. For systems with multiple pumps and one display, select the desired pump (1 to 8), using the pull-down menu.
2. Select the desired profile (1 to 4), using the pull-down menu.
3. In **flow mode**, set the desired maximum pump fluid pressure, as a percentage of the maximum pressure of your pump. **NOTE:** The motor will not run if the profile does not have a maximum pressure setting. This field is not used in pressure mode.

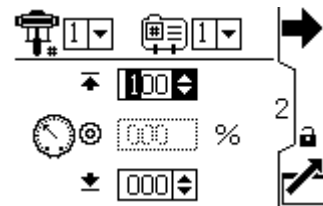

4. In **pressure mode**, set the desired fluid pressure target as a percentage of the maximum pressure of your pump. This field is not used in flow mode.

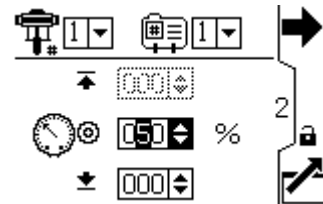









NOTE: If closed loop pressure is enabled, the target pressure will be displayed as a pressure value rather than a percentage of maximum pressure. See [Setup Screens 8 and 9, page 24](#) to enable closed loop pressure control.

5. If desired, set a minimum pump fluid pressure, as a percentage of the maximum fluid pressure of your pump.

Setup Screen 3

Use this screen to set your flow rate settings for a selected pump and profile. In pressure mode, you will set a maximum flow rate. In flow mode, you will set a target flow rate. In either pressure or flow mode, a minimum flow rate may be set if desired. See Setup Screen 4 to specify how the system will respond if the pump begins to operate outside of the set boundaries.

Setup Screen 3 Key	
	Enter the screen to set or change preferences.
	Pump selection — See Step 1.
	Profile selection — See Step 2.
	Flow rate maximum— See Step 3.
	Flow rate target— See Step 4.
	Flow rate minimum — See Step 5.
	Press to accept the selections.
	This softkey is disabled by default, and only appears if the “Profile Lock” box is checked on Setup Screen 15, page 29 . Press to activate the profile just edited.
	Exit data editing.

NOTE: With flow rate units of cc/min, the maximum value that can be displayed is 9999. If the field displays #####, the saved value is out of range. Go to [Setup Screen 13, page 27](#) and change the flow rate to a larger unit. Return to this screen and reduce the setting to a lower value that will be within the display’s range, then reset the flow rate units to cc/min.

1. For systems with multiple pumps and one display, select the desired pump (1 to 8), using the pull-down menu.
2. Select the desired profile (1 to 4), using the pull-down menu.
3. **In flow mode**, set a target flow rate. This field is not used in pressure mode.

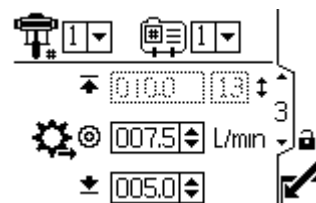

Figure 19 Flow Mode: Flow Rate Settings

4. **In pressure mode**, set the maximum flow rate. The software will calculate the number of pump cycles needed to achieve that flow rate. This field is not used in flow mode.

NOTE: The motor will not run if the profile does not have a maximum flow rate setting.

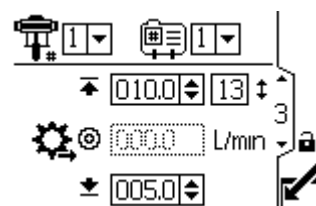

Figure 20 Pressure Mode: Flow Rate Settings

5. If desired, set a minimum flow rate.

Setup Screen 4

Use this screen to specify how the system will respond if the pump begins to operate outside of the pressure and flow settings established on Setup Screen 2 and Setup Screen 3. The operating mode (pressure or flow, set on Setup Screen 1) determines which fields are active.

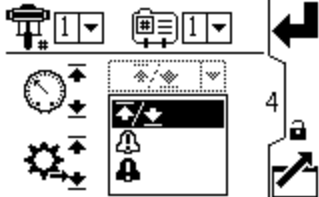











Figure 21 Alarm Preference Menu

-  **Limit:** The pump continues to run and issues no alert.
 - Maximum pressure set to Limit: The system reduces the flow if necessary to prevent the pressure from exceeding the limit.
 - Maximum flow set to Limit: The system reduces the pressure if necessary to prevent the flow from exceeding the limit.
 - Minimum pressure or flow set to Limit: The system takes no action. Use this setting if no minimum pressure or flow setting is desired.
-  **Deviation:** The system alerts you to the problem, but the pump may continue to run past the maximum or minimum settings until the system's absolute pressure or flow boundaries are reached.
-  **Alarm:** The system alerts you to the alarm cause and shuts down the pump.

Setup Screen 4 Key	
	Enter the screen to set or change preferences.
	Pressure Alarm Enable Line 1 (Pressure Maximum): use dropdown menu to set as Limit, Deviation, or Alarm. Line 2 (Pressure Minimum): use dropdown menu to set as Limit, Deviation, or Alarm.
	Flow Rate Alarm Enable Line 3 (Flow Maximum): use dropdown menu to set as Limit, Deviation, or Alarm. Line 4 (Flow Minimum): use dropdown menu to set as Limit, Deviation, or Alarm.
	Press to accept the selections.
	This softkey is disabled by default, and only appears if the "Profile Lock" box is checked on Setup Screen 15, page 29 . Press to activate the profile just edited.
	Exit data editing.

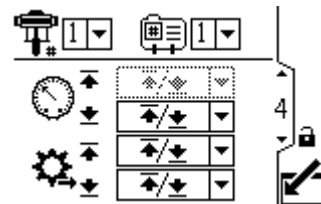

Figure 22 Setup Screen 4 (In Pressure Mode)

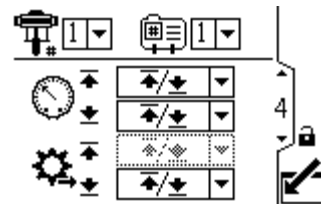





Figure 23 Setup Screen 4 (In Flow Mode)

Pressure Mode Examples

- **Runaway Control:** The user may choose to set the maximum flow to Alarm. If the flow rate exceeds the maximum entered on Setup Screen 3, an Alarm symbol  will show on screen and the pump will shut down.
- **Detect a Plugged Filter or Pipe:** The user may choose to set the minimum flow to Deviation. If the flow rate drops below the minimum entered on Setup Screen 3, a Deviation symbol  will show on screen to warn the user that action should be taken. The pump continues to run.

Flow Mode Examples

- **Runaway Control:** The user may choose to set the minimum pressure to Alarm. If a hose bursts, the pump will not change speed, but the back pressure will fall. When the pressure falls below the minimum entered on Setup Screen 2, an Alarm symbol  will show on screen and the pump will shut down.
- **Protect Connected Equipment:** The user may choose to set the maximum pressure to Limit to prevent the connected equipment from excessive pressure.
- **Detect a Plugged Filter or Pipe:** The user may choose to set the maximum pressure to Deviation. When the pressure exceeds the maximum entered on Setup Screen 2, a Deviation symbol  will show on screen to warn the user that action should be taken. The pump continues to run.

Setup Screen 5

Use this screen to set the lower pump size (cc) of each pump. The default is blank; select the correct lower size, or custom. If custom is selected, enter the size of the lower in cc. This screen also activates jog mode, allowing you to position the motor/pump shaft for connection or disconnection.

NOTE: The motor will limit its pressure output when the selected lower is 750cc, to prevent exceeding the pressure rating of the lower.

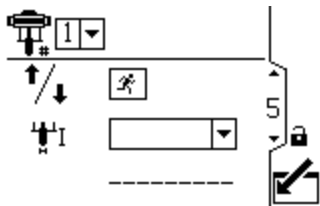

Figure 24 Setup Screen 5

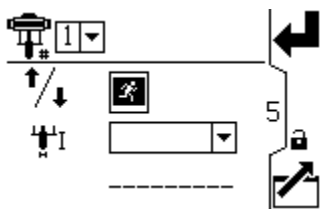

Figure 25 Select Jog Mode

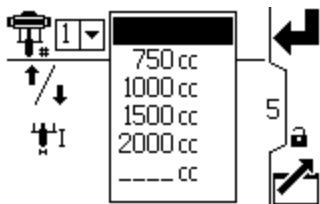

Figure 26 Select Pump Lower

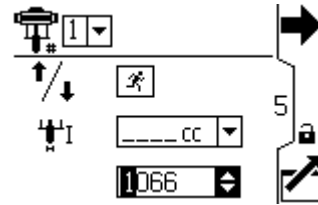

Figure 27 Select a Custom Lower

Setup Screen 5 Key	
	Enter the screen.
	For systems with multiple pumps and one display, select the desired pump (1 to 8), using the pull-down menu.
	Select to enable jog mode. Use the arrow keys to move the motor/pump shaft up or down.
	Select the correct pump lower size from the drop-down menu. The default is blank. If custom is selected, a field will open to input the size of the lower in cc.
	Press to accept the selections.
	Exit the screen.

Setup Screen 6

Use this screen to view the grand totalizer value and set or reset the batch totalizer.

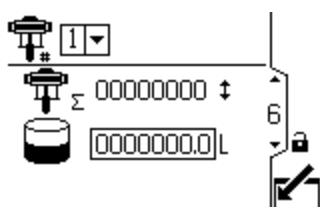

Figure 28 Setup Screen 6

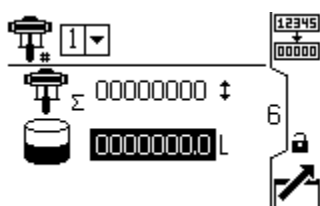

Figure 29 Reset the Totalizer

Setup Screen 6 Key	
	Enter the screen to set or change preferences.
	Grand Totalizer - displays the current grand total of pump cycles. Not resettable.
	Batch Totalizer - displays the batch total in selected volume units.
	Reset Batch Totalizer - resets the batch totalizer to zero.
	Press to accept the selections.
	Exit data editing.

Setup Screen 7

Use this screen to set the desired maintenance interval (in cycles) for each pump. The screen also displays the current cycle count. An Advisory is issued when the counter reaches 0 (zero).

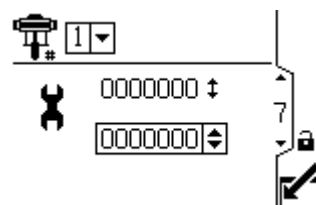

Figure 30 Setup Screen 7

Setup Screen 7 Key	
	Enter the screen.
	For systems with multiple pumps and one display, select the desired pump (1 to 8), using the pull-down menu.
	Set the desired maintenance interval (in cycles) for each pump.
	Press to accept the selections.
	Exit the screen.

Setup Screens 8 and 9

Use these screens to set up the pressure transducers. The screens are identical, except Screen 8 is for transducer 1 and Screen 9 is for transducer 2. Selecting a transducer and a pump activates closed loop pressure control.

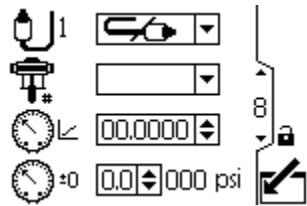

Figure 31 Setup Screens 8 and 9 (Screen 8 shown)

Setup Screens 8 and 9 Key	
	Select from the dropdown options to enable the transducer.
	For systems with multiple pumps and one display, select the desired pump (1 to 8), using the pull-down menu. Enables closed loop pressure control and assigns the transducer to a pump.
	Enter the calibration scale factor from the transducer label.
	Enter the calibration offset value from the transducer label.
000 psi	Displays the current transducer reading.
	Exit data editing.
	Move between Setup Screens, fields on a screen, or to increment/decrement the digits when editing number fields.

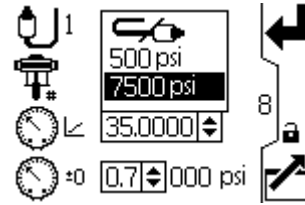

Figure 32 Select Pressure Transducer

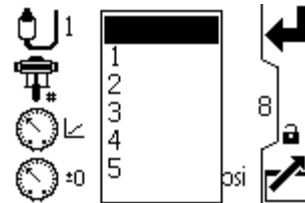

Figure 33 Select Pump, to Enable Closed Loop Pressure Control

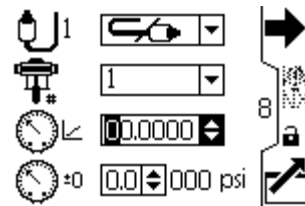

Figure 34 Enter Calibration Scale Factor

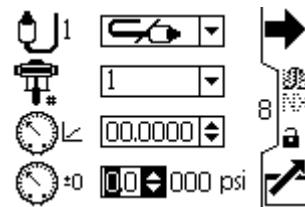

Figure 35 Enter Calibration Offset Value

Setup Screens 10 and 11

These screens are auto-populated by the software. Screen 10 displays the serial numbers of motors 1–4, and Screen 11 displays the serial numbers of motors 5–8.

NOTE: Changing the pump order will shift every other pump up one position. For example, if AD00001 is changed to be pump 4, AD00002 will become pump 1, AD00003 will become pump 2, and so on.

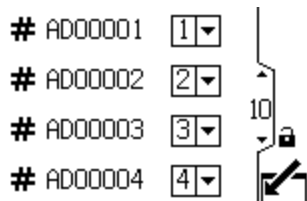

Figure 36 Setup Screens 10 and 11 (Screen 10 shown)



Figure 37 Select a Pump Number for Each Serial Number

Setup Screen 12

Use this screen to set your modbus preferences.

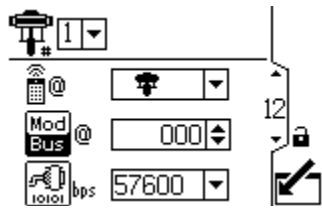

Figure 38 Setup Screen 12

Setup Screen 12 Key	
	Enter the screen.
	For systems with multiple pumps and one display, select the desired pump (1 to 8), using the pull-down menu.
	Control location. Select local or remote control from the dropdown options. Setting applies to the selected pump only.
	Enter or change the Modbus node ID. Value is between 1 and 247. Each pump requires a unique node ID, which identifies that pump if more than one pump is connected to the display..
	Select serial port baud rate from the dropdown options: 57600 or 115200. This is a system-wide setting.
	Press to accept the selections.
	Exit data editing.

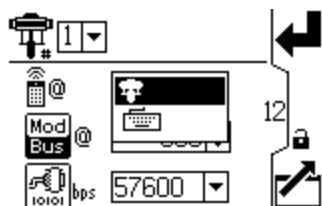

Figure 39 Select Local or Remote Control

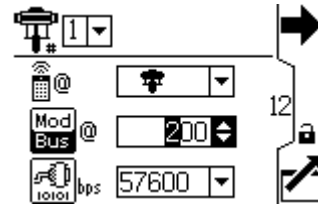

Figure 40 Set Modbus Node ID

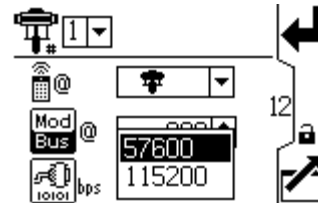

Figure 41 Set Baud Rate (Bits Per Second)

NOTE:The following are fixed modbus settings, which cannot be set or changed by the user: 8 data bits, 2 stop bits, no parity.

Setup Screen 13

Use this screen to set the desired units for pressure, totals, and flow.

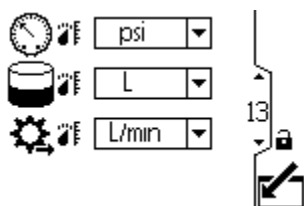

Figure 42 Setup Screen 13

Setup Screen 13 Key	
	Select desired pressure units (psi, bar, or MPa)
	Select desired volume units (liters or gallons)
	Select desired flow rate units (L/min, gpm, cc/min, oz/min, or cycles/min)
	Exit data editing.
	Move between Setup Screens, fields on a screen, or to increment/decrement the digits when editing number fields.



Figure 43 Select Desired Pressure Units

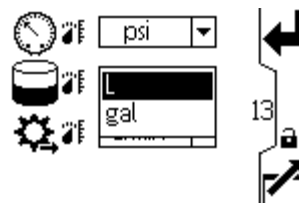

Figure 44 Select Desired Volume Units

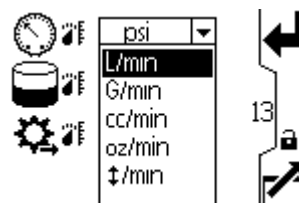

Figure 45 Select Desired Flow Rate Units

Setup Screen 14

Use this screen to set your date format, date, and time.

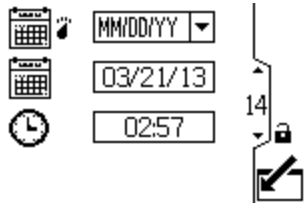

Figure 46 Setup Screen 14

Setup Screen 14 Key	
	Enter the screen to set or change preferences.
	Select your preferred date format from the dropdown menu.
	MM/DD/YY
	DD/MM/YY
	Set the correct date.
	YY/MM/DD
	Set the correct time.
	Press to accept the selections.
	Exit data editing.



Figure 47 Select the Date Format

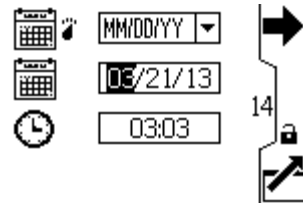

Figure 48 Set the Date

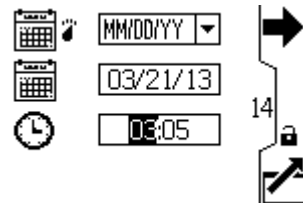

Figure 49 Set the Time

Setup Screen 15

Use this screen to enter a password that will be required to access the Setup screens. This screen also displays the software version.

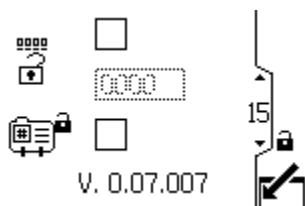

Figure 50 Setup Screen 15

Setup Screen 15 Key	
	Enter the screen to set the password.
<input checked="" type="checkbox"/>	When the top box of the screen is checked, the password is active. To temporarily disable the password, uncheck the box. The password field will be grayed-out.
	Enter the desired 4-digit password.
	Check the box to lock out the profile field in the Run screens.
	Exit data editing.

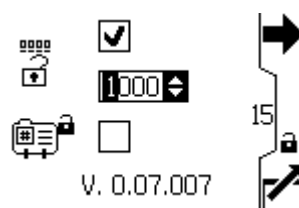

Figure 51 Set the Password

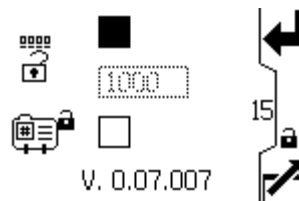

Figure 52 Disable the Password

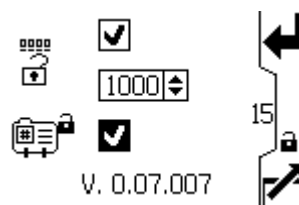



Figure 53 Lock the Profile

Error Code Troubleshooting

Error codes can take three forms:

- Alarm  : alerts you to the alarm cause and shuts down the pump.
- Deviation  : alerts you to the problem, but pump may continue to run past the set limits until the system's absolute limits are reached.
- Advisory: information only. Pump will continue to operate.



NOTE: On Advanced motors, flow (K codes) and pressure (P codes) can be designated as alarms or deviations. See [Setup Screen 4, page 20](#).

NOTE: In the error codes listed below, an “X” means the code is associated with the display only.

NOTE: In the error codes listed below, a “_” in the code is a placeholder for the number of the pump where the event occurred.

NOTE: The blink code is displayed using the power indicator on the motor. The blink code given below indicates the sequence. For example, blink code 1–2 indicates 1 blink, then 2 blinks; the sequence then repeats.

NOTE: A blink code of 9 is not an error code, but an indicator of which pump is active ( softkey has been pushed, see [Run Screen 1, page 12](#)).

Display Code	Applicable Motor	Blink Code	Alarm or Deviation	Description
None	Basic	6	Alarm	The Mode Select knob is set between Pressure  and Flow  . Set knob to the desired mode.
None	Basic and Advanced	9	None	A blink code of 9 is not an error code, but an indicator of which pump is active.
CAC_	Advanced	None	Alarm	Display detects a loss of CAN communication. Flashing alarm appears on the display, and the blink code occurs.
CAD_	Advanced	2–3	Alarm	Unit detects a loss of CAN communication. This alarm is only logged. No flashing alarm appears on the display, but the blink code does occur.
CAG_	Advanced	2–4	Alarm	Display detects a loss of modbus communication when control access is set to modbus.
CCN_	Basic and Advanced	3–6	Alarm	Circuit board communication failure.
K1D_	Advanced	1–2	Alarm	Flow is below minimum limit.
K2D_	Advanced	None	Deviation	Flow is below minimum limit.
K3D_	Advanced	None	Deviation	Flow exceeds maximum target; also indicates pump runaway condition exists.
K4D_	Basic and Advanced	1	Alarm	Flow exceeds maximum target; also indicates pump runaway condition exists.

Display Code	Applicable Motor	Blink Code	Alarm or Deviation	Description
MND_	Advanced	None	Advisory	Maintenance counter is enabled and countdown reached zero (0).
P1I_	Advanced	1-3	Alarm	Pressure is below minimum limit.
P2I_	Advanced	None	Deviation	Pressure is below minimum limit.
P3I_	Advanced	None	Deviation	Pressure exceeds maximum target.
P4I_	Advanced	1-4	Alarm	Pressure exceeds maximum target.
P5DX	Advanced	None	Deviation	More than one pump is assigned to a transducer. The assignment for that transducer is automatically cleared under this condition. User must reassign.
P6CA or P6CB	Advanced	None	Deviation	For units without closed loop pressure control: Transducer (A or B) is enabled but not detected.
P6D_	Advanced	1-6	Alarm	For units with closed loop pressure control: Transducer is enabled but not detected.
T2D_	Basic and Advanced	3-5	Alarm	Internal thermistor disconnected.
T3D_	Basic and Advanced	5	Deviation	Over temperature.
V1I_	Basic and Advanced	2	Alarm	Brown out; voltage supplied to motor is too low.
V1M_	Basic and Advanced	2-6	Alarm	AC power is lost.
V4I_	Basic and Advanced	3	Alarm	Voltage supplied to motor is too high.
WMC_	Basic and Advanced	4-5	Alarm	Internal software error.
WNC_	Basic and Advanced	3-4	Alarm	Software versions do not match.
WSC_	Advanced	None	Deviation	Profile is set to 0 pressure or 0 flow.
WSD_	Advanced	1-5	Alarm	Invalid lower size; occurs if the unit is operated before setting up the lower size.
WXD_	Basic and Advanced	4	Alarm	An internal circuit board hardware failure is detected.

Parts

24P822 Control Module Kit

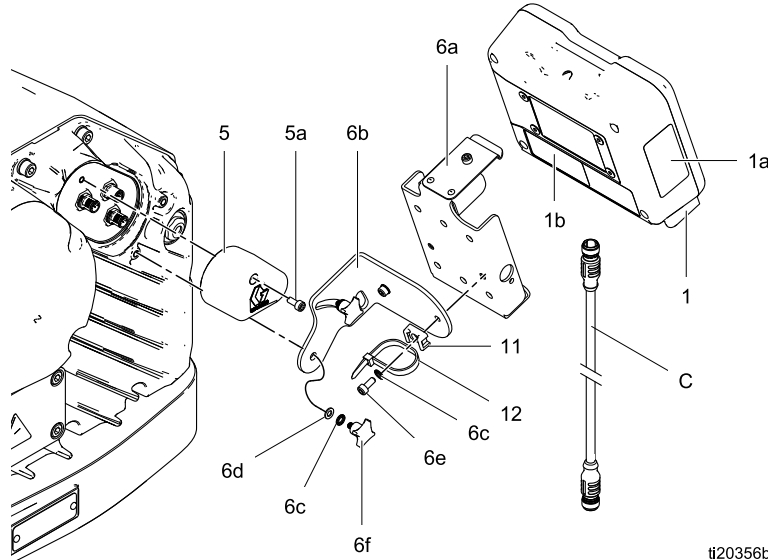

ti20356b

Ref	Part	Description	Qty	Ref	Part	Description	Qty
1	24P821	DISPLAY KIT, control module; includes item 1a; see manual 332013 for approvals information about the bare ADCM module	1	6a	— — —	BRACKET, control module	1
1a▲	16P265	LABEL, warning, English	1	6b	— — —	BRACKET, mounting	1
1b▲	16P265	LABEL, warning, French	1	6c	— — —	LOCKWASHER, external tooth; M5	4
1c▲	16P265	LABEL, warning, Spanish (shipped loose)	1	6d	— — —	WASHER; M5	2
5	24N910	CONNECTOR, jumper; includes item 5a	1	6e	— — —	SCREW, cap, socket head; M5 x 12 mm	2
5a	— — —	SCREW, cap, socket head; M5 x 40 mm	1	6f	— — —	KNOB; M5 x 0.8	2
6	24P823	BRACKET KIT, control module; includes items 6a-6f	1	11	— — —	HOLDER, tie	1
				12	— — —	STRAP, tie	1

▲ Replacement Danger and Warning labels, tags, and cards are available at no cost.

Items marked — — — are not available separately.

Cable (C) is shown for reference but is not included in the kit. Order desired length separately. See [Cable Connection, page 5](#).

Accessory Kits

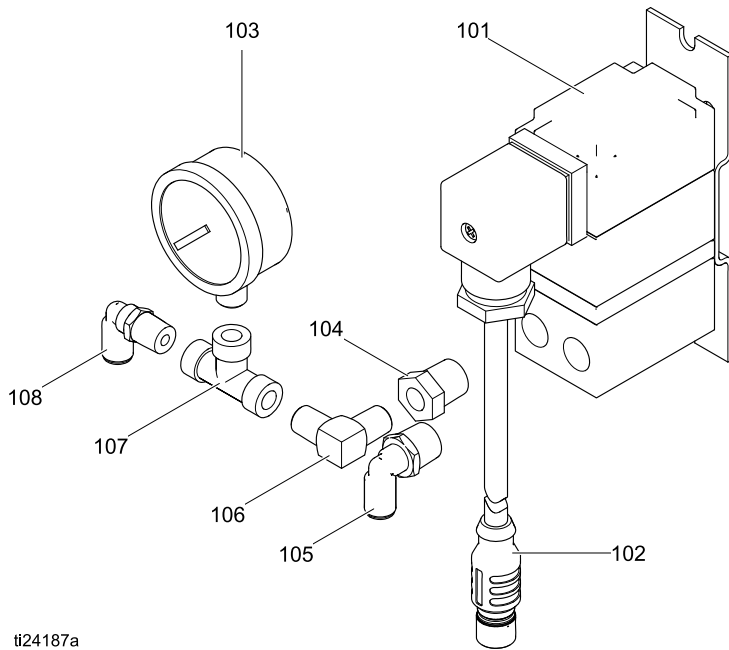

ti24187a

BPR Controller Kit 24V001

Ref	Part	Description	Qty
101	---	TRANSDUCER, miniature	1
102	---	CABLE, F/C, I.S., 8 M	1
103	110436	GAUGE, pressure, air	1
104	100030	BUSHING	1
105	198178	ELBOW	1

Ref	Part	Description	Qty
106	110207	ELBOW	1
107	C19466	TEE	1
108	198171	ELBOW	1

--- *Parts not sold separately.*

Start/Stop Switch Kit 16U729

The kit includes the switch and enclosure, a mounting bracket, and cables. Parts are not sold separately.

Pressure Transducer Kit 24R050 (for 4-Ball pumps) and Kit 24Y245 (for 2-Ball pumps)

Each kit includes the fluid pressure sensor with cable, an adaptor, and an o-ring. Parts are not sold separately.

Appendix A - Modbus Variable Map

To communicate through fiber optics with the E-Flo DC Control Module, reference the appropriate hardware as shown in manual 332356. That manual indicates various options for connecting fiber optic cables from the control module to the non-hazardous area. The following table lists Modbus registers available to a PC or PLC located in the non-hazardous area.

Table 4 shows the registers needed for basic operation, monitoring, and alarm control features. Tables 5 and 6 provide bit definitions as needed for certain registers. Table 7 shows the units and how to convert the register value to a unit value.

Reference the Modbus communication settings selected in [Setup Screen 12, page 26](#).

Table 4 Modbus Registers

Modbus Register	Variable	Register Access	Size	Notes/Units
404100	Pump Status Bits	Read Only	16 Bit	See Table 5 for bit definitions.
404101	Actual Pump Speed	Read Only	16 Bit	Speed units, see Table 7.
404102	Actual Pump Flow Rate	Read Only	16 Bit	Flow units, see Table 7..
404103	Actual Pump Pressure	Read Only	16 Bit	Percent pressure, see Table 7.
404104	Transducer 1 Pressure	Read Only	16 Bit	Pressure units, see Table 7.
404105	Transducer 2 Pressure	Read Only	16 Bit	Pressure units, see Table 7.
404106	Batch Total High Word	Read Only	16 Bit	Volume units, see Table 7.
404107	Batch Total Low Word	Read Only	16 Bit	Volume units, see Table 7.
404108	Grand Total High Word	Read Only	16 Bit	Pump cycles, see Table 7.
404109	Grand Total Low Word	Read Only	16 Bit	Pump cycles, see Table 7.
404110	Maintenance Total High Word	Read Only	16 Bit	Pump cycles, see Table 7.
404111	Maintenance Total Low Word	Read Only	16 Bit	Pump cycles, see Table 7.
404112	Pump Alarms High Word	Read Only	16 Bit	See Table 5 for bit definitions.
404113	Pump Alarms Low Word	Read Only	16 Bit	See Table 5 for bit definitions.
404114	Display Alarms High Word	Read Only	16 Bit	See Table 5 for bit definitions.
404115	Display Alarms Low Word	Read Only	16 Bit	See Table 5 for bit definitions.
<hr/>				
404200	Local/Remote Control	Read / Write	16 Bit	0 = local, 1 = remote/PLC
404201	Active Profile Number	Read / Write	16 Bit	0 = stopped, 1, 2, 3, 4
404202	Pump Control Bitfield	Read / Write	16 Bit	See Table 5 for bit definitions.
404203	Maintenance Interval High Word	Read / Write	16 Bit	Pump cycles, see Table 7.
404204	Maintenance Interval Low Word	Read / Write	16 Bit	Pump cycles, see Table 7.
<hr/>				
403102	Display seconds	Read Only	16 Bit	Use as heartbeat.

NOTE: See [Error Code Troubleshooting, page 30](#), for a description of each alarm.

Table 5 Alarm Bits

404112 - Pump Alarms Word 1			
Bit	Event Type	Event Code	Event Name
0	Deviation	T3D_	Over Temperature
2	Alarm	P6D_	Pressure Transducer Missing
3	Deviation	ERR_	Internal Software Error
4	Advisory	MND_	Maintenance Count
5	Alarm	V1M_	AC Power Loss
6	Alarm	T2D_	Low Temperature
7	Alarm	WNC_	Version Mismatch
8	Alarm	CCN_	IPC Communication
9	Alarm	WMC_	Internal software error
10	Deviation	P5D_	Multiple Pumps Assigned to Transducer
11	Deviation	WSC_	Zero setting on active profile
others			Reserved
404113 - Pump Alarms Word 2			
Bit	Event Type	Event Code	Event Name
0	Alarm	K1D_	Minimum Speed
1	Deviation	K2D_	Minimum Speed
2	Alarm	K4D_	Maximum Speed
3	Deviation	K3D_	Maximum Speed
4	Alarm	P1I_	Minimum Pressure
5	Deviation	P2I_	Minimum Pressure
6	Alarm	P4I_	Maximum Pressure
7	Deviation	P3I_	Maximum Pressure
8	Alarm	V1I_	Under Voltage
9	Alarm	V4I_	Over Voltage
10	Alarm	V4I_	High Pressure 120V
11	Alarm	CAD_	CAN Communication Pump
13	Alarm	WXD_	Board Hardware
14	Alarm	WSD_	Invalid Lower Size
others			Reserved

404114 - Display Alarms Word 1			
Bit	Event Type	Event Code	Event Name
1	Deviation	P6C_	Pressure Transducer Missing
others			Reserved
404115 - Display Alarms Word 2			
Bit	Event Type	Event Code	Event Name
12	Alarm	CAG_	Modbus Communication
15	Alarm	CAC_	CAN Communication Display
others			Reserved

Table 6 Pump Status and Control Bits

404100 - Pump Status Bits	
Bit	Meaning
0	Reads 1 if the pump is trying to move
1	Reads 1 if the pump is actually moving
2	Reads 1 if there are any active alarms
3	Reads 1 if there are any active deviations
4	Reads 1 if there are any active advisories
others	Reserved for future use
404202 - Pump Control Bits	
Bit	Meaning
0	Reads 0 for an active alarm or deviation. Reset to 1 to clear.
1	Set to 1 to reset the batch total
2	Set to 1 to reset the maintenance counter
others	Reserved for future use - only write 0

Table 7 Units

Unit Type	Selectable Units	Units Register	Converting registers to unit values	Register value for 1 unit
Pressure	Percent	n/a	Pressure = Register	1 = 1% Pressure
Pressure	psi	403208 = 0	Pressure = Register	1 = 1 psi
	Bar	403208 = 1	Pressure = Register/10	10 = 1.0 Bar
	MPa	403208 = 2	Pressure = Register/100	100 = 1.00 Mpa
Speed	Cycles/min	n/a	Speed = Register/10	10 = 1.0 cycle/min
Flow	Liters/min	403210 = 0	Flow = Register/10	10 = 1.0 L/min
	Gallons/min	403210 = 1	Flow = Register/10	10 = 1.0 Gal/min
	cc/min	403210 = 2	Flow = Register	1 = 1 cc/min
	oz/min	403210 = 3	Flow = Register	1 = 1 oz/min
	Cycles/min	403210 = 4	Flow = Register/10	10 = 1.0 cycle/min
Volumet	Liters	403209 = 0	Volume = 1000*High + Low/10	0 (High) / 10 (Low) = 1.0 L
	Gallons	403209 = 1	Volume = 1000*High + Low/10	0 (High) / 10 (Low) = 1.0 Gal
Cyclest†	Pump Cycles	n/a	Cycles = 10000*High + Low	0 (High) / 1 (Low) = 1 cycle

† Example of converting volume register reading to units: If the reading for register 404106 (volume high word) is 12, and the reading for register 404107 (volume low word) is 34, the volume is 12003.4 liters. $12 * 1000 + 34/10 = 12003.4$.

†† Example of converting cycles register reading to units: If the reading for register 404108 (cycles high word) is 75, and the reading for register 404109 (cycles low word) is 8000, the volume is 758,000 cycles. $75 * 10000 + 8000 = 758000$.

Appendix B. Pump Control from a PLC

This guide shows how to use the information in Appendix A to control a pump remotely from a PLC. The steps progress from basic pump control to more advanced monitoring and alarm control features.

It is important that you first follow all directions in the Setup Screens to configure your system properly. Test that the pump operates correctly when controlled from the Display. Make sure the display, fiber optics, communication gateway, and PLC are connected properly. Refer to Communication Kit manual. Use Setup Screen 12 to enable remote control and set your modbus preferences.

1. **Enable PLC control:** Set register 404200 to 1.
2. **Run a pump:** Set register 404201. Enter 0 for stopped, 1 to 4 for the desired profile.
3. **View pump profile:** Read register 404201. This register updates automatically to reflect the actual pump status. If the profile is changed from the display, this register changes as well. If the pump stops due to an alarm, this register will read 0.
4. **View pump status:** Read register 404100 to see the status of the pump. See Appendix A, Table 6, for a description of each bit.
 - Example 1: Register 404100, bit 1, reads 1 if the pump is currently moving.
 - Example 2: Register 404100, bit 2 reads 1 if the pump has an active alarm.
5. **Monitor alarms and deviations:** Read register 404112 to 404115. Each bit in these registers corresponds to an alarm or deviation. See Appendix A, Table 5. I
 - Example 1: Pressure falls below the minimum setting entered on Setup Screen 2. It will show on bit 4 of register 404113 if minimum pressure is set to Alarm, and on bit 5 of register 404113 if minimum pressure is set to Deviation.
 - Example 2: The system is set up for a pressure transducer on Setup Screen 8, but no transducer is detected. It will show on bit 1 of register 404114.
6. **Monitor pump cycle rate, flow rate, and pressure:** Read registers 404101 to 404105. Note that pressure is available only if a pressure transducer is connected to the display. Register 404104 shows the pressure on transducer 1. Register 404105 shows the pressure on transducer 2. See Appendix A, Table 7 for units for these registers.
 - Example 1: If register 404101 reads 75, the pump speed is 7.5 cycles/minute.
 - Example 2: If register 404103 reads 67, the pump is operating at 67 percent pressure.
7. **Reset active alarms and deviations:** Clear the condition that caused the alarm. Set register 404202, bit 0, to 1 to clear the alarm. The pump will be in profile 0 due to the alarm. Set 404201 to the desired profile to run the pump again.

Graco Standard Warranty

Graco warrants all equipment referenced in this document which is manufactured by Graco and bearing its name to be free from defects in material and workmanship on the date of sale to the original purchaser for use. With the exception of any special, extended, or limited warranty published by Graco, Graco will, for a period of twelve months from the date of sale, repair or replace any part of the equipment determined by Graco to be defective. This warranty applies only when the equipment is installed, operated and maintained in accordance with Graco's written recommendations.

This warranty does not cover, and Graco shall not be liable for general wear and tear, or any malfunction, damage or wear caused by faulty installation, misapplication, abrasion, corrosion, inadequate or improper maintenance, negligence, accident, tampering, or substitution of non-Graco component parts. Nor shall Graco be liable for malfunction, damage or wear caused by the incompatibility of Graco equipment with structures, accessories, equipment or materials not supplied by Graco, or the improper design, manufacture, installation, operation or maintenance of structures, accessories, equipment or materials not supplied by Graco.

This warranty is conditioned upon the prepaid return of the equipment claimed to be defective to an authorized Graco distributor for verification of the claimed defect. If the claimed defect is verified, Graco will repair or replace free of charge any defective parts. The equipment will be returned to the original purchaser transportation prepaid. If inspection of the equipment does not disclose any defect in material or workmanship, repairs will be made at a reasonable charge, which charges may include the costs of parts, labor, and transportation.

THIS WARRANTY IS EXCLUSIVE, AND IS IN LIEU OF ANY OTHER WARRANTIES, EXPRESS OR IMPLIED, INCLUDING BUT NOT LIMITED TO WARRANTY OF MERCHANTABILITY OR WARRANTY OF FITNESS FOR A PARTICULAR PURPOSE.

Graco's sole obligation and buyer's sole remedy for any breach of warranty shall be as set forth above. The buyer agrees that no other remedy (including, but not limited to, incidental or consequential damages for lost profits, lost sales, injury to person or property, or any other incidental or consequential loss) shall be available. Any action for breach of warranty must be brought within two (2) years of the date of sale.

GRACO MAKES NO WARRANTY, AND DISCLAIMS ALL IMPLIED WARRANTIES OF MERCHANTABILITY AND FITNESS FOR A PARTICULAR PURPOSE, IN CONNECTION WITH ACCESSORIES, EQUIPMENT, MATERIALS OR COMPONENTS SOLD BUT NOT MANUFACTURED BY GRACO. These items sold, but not manufactured by Graco (such as electric motors, switches, hose, etc.), are subject to the warranty, if any, of their manufacturer. Graco will provide purchaser with reasonable assistance in making any claim for breach of these warranties.

In no event will Graco be liable for indirect, incidental, special or consequential damages resulting from Graco supplying equipment hereunder, or the furnishing, performance, or use of any products or other goods sold hereto, whether due to a breach of contract, breach of warranty, the negligence of Graco, or otherwise.

FOR GRACO CANADA CUSTOMERS

The Parties acknowledge that they have required that the present document, as well as all documents, notices and legal proceedings entered into, given or instituted pursuant hereto or relating directly or indirectly hereto, be drawn up in English. Les parties reconnaissent avoir convenu que la rédaction du présente document sera en Anglais, ainsi que tous documents, avis et procédures judiciaires exécutés, donnés ou intentés, à la suite de ou en rapport, directement ou indirectement, avec les procédures concernées.

Graco Information

For the latest information about Graco products, visit www.graco.com.
For patent information, see www.graco.com/patents.

To place an order, contact your Graco Distributor or call to identify the nearest distributor.

Phone: 612-623-6921 or **Toll Free:** 1-800-328-0211 **Fax:** 612-378-3505

All written and visual data contained in this document reflects the latest product information available at the time of publication. Graco reserves the right to make changes at any time without notice

Original Instructions. This manual contains English. MM 3A2527

Graco Headquarters: Minneapolis
International Offices: Belgium, China, Japan, Korea
GRACO INC. AND SUBSIDIARIES • P.O. BOX 1441 • MINNEAPOLIS MN 55440-1441 • USA
Copyright 2013, Graco, Inc. All Graco manufacturing locations are registered to ISO 9001.

www.graco.com
Revision E, April 2015

Free Manuals Download Website

<http://myh66.com>

<http://usermanuals.us>

<http://www.somanuals.com>

<http://www.4manuals.cc>

<http://www.manual-lib.com>

<http://www.404manual.com>

<http://www.luxmanual.com>

<http://aubethermostatmanual.com>

Golf course search by state

<http://golfingnear.com>

Email search by domain

<http://emailbydomain.com>

Auto manuals search

<http://auto.somanuals.com>

TV manuals search

<http://tv.somanuals.com>