



14 GAUGE SWIVEL HEAD SHEARS

MODEL H5503

INSTRUCTION MANUAL



COPYRIGHT © JUNE, 2003 BY GRIZZLY INDUSTRIAL, INC.

WARNING: NO PORTION OF THIS MANUAL MAY BE REPRODUCED IN ANY SHAPE OR FORM WITHOUT THE WRITTEN APPROVAL OF GRIZZLY INDUSTRIAL, INC.

PRINTED IN CHINA

ONLINE MANUAL DISCLAIMER

THE INFORMATION IN THIS MANUAL REPRESENTS THE CONFIGURATION OF THE MACHINE AS IT IS CURRENTLY BEING SHIPPED. THE MACHINE CONFIGURATION CAN CHANGE AS PRODUCT IMPROVEMENTS ARE INCORPORATED. IF YOU OWN AN EARLIER VERSION OF THE MACHINE, THIS MANUAL MAY NOT EXACTLY DEPICT YOUR MACHINE. CONTACT CUSTOMER SERVICE IF YOU HAVE ANY QUESTIONS ABOUT DIFFERENCES. PREVIOUS VERSIONS ARE NOT AVAILABLE ONLINE.

WARNING

Some dust created by power sanding, sawing, grinding, drilling, and other construction activities contains chemicals known to the State of California to cause cancer, birth defects or other reproductive harm. Some examples of these chemicals are:

- Lead from lead-based paints.
- Crystalline silica from bricks, cement, and other masonry products.
- Arsenic and chromium from chemically treated lumber.

Your risk from these exposures varies, depending on how often you do this type of work. To reduce your exposure to these chemicals: work in a well ventilated area, and work with approved safety equipment, such as those dust masks that are specially designed to filter out microscopic particles.

SAFETY

WARNING

For Your Own Safety Read Instruction Manual Before Operating This Equipment

The purpose of safety symbols is to attract your attention to possible hazardous conditions. This manual uses a series of symbols and signal words which are intended to convey the level of importance of the safety messages. The progression of symbols is described below. Remember that safety messages by themselves do not eliminate danger and are not a substitute for proper accident prevention measures.

 **DANGER** Indicates an imminently hazardous situation which, if not avoided, WILL result in death or serious injury.

 **WARNING** Indicates a potentially hazardous situation which, if not avoided, COULD result in death or serious injury.

 **CAUTION** Indicates a potentially hazardous situation which, if not avoided, MAY result in minor or moderate injury. It may also be used to alert against unsafe practices.

NOTICE This symbol is used to alert the user to useful information about proper operation of the equipment.

WARNING

Safety Instructions For Power Tools

- KEEP ALL SAFETY DEVICES IN PLACE** and in working order.
- REMOVE ADJUSTING KEYS AND WRENCHES.** Form a habit of checking to see that keys and adjusting wrenches are removed from tool before operation.
- KEEP WORK AREA CLEAN.** Cluttered areas and benches invite accidents.
- DO NOT USE IN DANGEROUS ENVIRONMENT.** DO NOT use power tools in damp or wet locations, or where any flammable or noxious fumes may exist. Keep work area well lighted.
- KEEP CHILDREN AND VISITORS AWAY.** All children and visitors should be kept a safe distance from work area.
- WATCH FOR SHARP EDGES,** this tool may produce a sharp edge on sheet metal.
- DO NOT FORCE TOOL.** It will do the job better and safer at the rate for which it was designed.
- USE THE RIGHT TOOL.** DO NOT force tool or attachment to do a job for which it was not designed.
- DO NOT USE UNDER THE INFLUENCE OF DRUGS OR ALCOHOL.**

WARNING

Safety Instructions For Power Tools

- 10. USE PROPER EXTENSION CORD** for the tool. Make sure your extension cord is in good condition. Conductor size should be in accordance with the chart below. The amperage rating should be listed on the motor or tool nameplate. An undersized cord will cause a drop in line voltage resulting in loss of power and overheating. Your extension cord must also contain a ground wire and plug pin. Always repair or replace extension cords if they become damaged.

Minimum Gauge for Extension Cords

AMP RATING	LENGTH		
	25ft	50ft	100ft
0-6	16	16	16
7-10	16	16	14
11-12	16	16	14
13-16	14	12	12
17-20	12	12	10
21-30	10	10	No

- 11. WEAR PROPER APPAREL.** DO NOT wear loose clothing, gloves, neckties, rings, bracelets, or other jewelry which may get caught in moving parts. Non-slip footwear is recommended. Wear protective hair covering to contain long hair.
- 12. ALWAYS USE SAFETY GLASSES.** Also use face or dust mask if cutting operation is dusty. Everyday eyeglasses only have impact resistant lenses, they are NOT safety glasses.
- 13. SECURE WORK.** Use clamps or a vise to hold work when practical. It is safer than using your hand and frees both hands to operate tool.
- 14. DO NOT OVERREACH.** Keep proper footing and balance at all times.
- 15. MAINTAIN TOOLS WITH CARE.** Keep tools sharp and clean for best and safest performance. Follow instructions for lubricating and changing accessories.
- 16. DISCONNECT TOOLS** before servicing and changing accessories.
- 17. REDUCE THE RISK OF UNINTENTIONAL STARTING.** Make sure switch is in off position before plugging in.
- 18. USE THE RECOMMENDED ACCESSORIES.** Consult the owner's manual for recommended accessories. The use of improper accessories may cause risk of injury.
- 19. CHECK DAMAGED PARTS.** Before further use of the tool, a guard or other part that is damaged should be carefully checked to determine that it will operate properly and perform its intended function. Check for alignment of moving parts, binding of moving parts, breakage of parts, mounting, and any other conditions that may affect its operation. A guard or other part that is damaged should be properly repaired or replaced.
- 20. NEVER LEAVE TOOL RUNNING UNATTENDED.** Turn the power off, and do not leave tool until it comes to a complete stop.
- 21. NEVER ALLOW UNTRAINED USERS TO RUN THIS TOOL WHILE UNSUPERVISED.**
- 22. IF YOU ARE UNSURE OF THE INTENDED OPERATION, STOP USING THE TOOL.** Seek formal training or research books or magazines that specialize in power tools.

INTRODUCTION

Commentary

We are proud to offer the Grizzly Model H5503 14 Gauge Swivel Head Shears. This model is part of a growing Grizzly family of fine power tools. When used according to the guidelines set forth in this manual, you can expect years of trouble-free, enjoyable operation and proof of Grizzly's commitment to customer satisfaction.

This shear features a 120 volt, 4 amp, $\frac{3}{4}$ HP motor and a heavy duty aluminum head that swivels 360°. It can cut up to 14 gauge mild steel and 18 gauge stainless steel, and is capable of cutting 12.5 feet per minute.

We are pleased to provide this manual with the Model H5503. It was written to encourage safety considerations and guide you through general operating procedures and maintenance. This manual represents our effort to produce the best documentation possible.

The specifications, details, and photographs in this manual represent the Model H5503 as supplied when the manual was prepared. However, owing to Grizzly's policy of continuous improvement, changes may be made at any time with no obligation on the part of Grizzly. If you have any comments regarding this manual, please write to us at the address below:

Grizzly Industrial, Inc.
%o Technical Documentation
P.O. Box 2069
Bellingham, WA 98227-2069

Most importantly, we stand behind our tools. If you have any service questions or parts requests, please call or write us at the location listed below.

Grizzly Industrial, Inc.
1203 Lycoming Mall Circle
Muncy, PA 17756
Phone: (570) 546-9663
Fax: (800) 438-5901
E-Mail: techsupport@grizzly.com
Web Site: <http://www.grizzly.com>

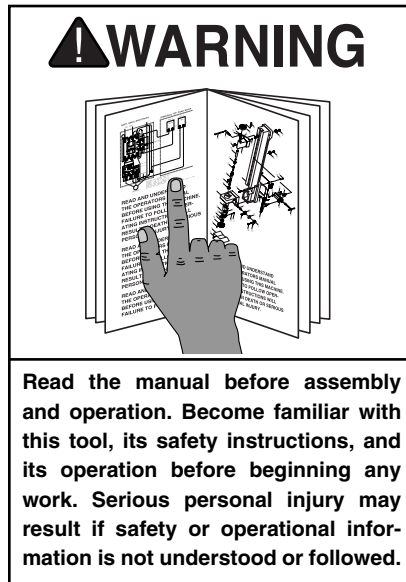

Read the manual before assembly and operation. Become familiar with this tool, its safety instructions, and its operation before beginning any work. Serious personal injury may result if safety or operational information is not understood or followed.

OPERATION

WARNING

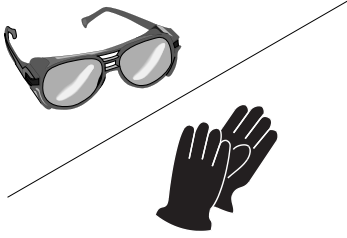

Operating these shears can propel objects into the air, causing immediate eye damage. To protect yourself, always wear American National Standards Institute (ANSI) approved safety glasses or goggles when operating this equipment. To protect your hands, always wear leather hand protection when operating this shear.

Test Run

Before performing any cutting operations, test run the tool.

1. Connect the tool to a power source and squeeze the trigger (**Figure 1**).
2. If everything appears to be in working order, you are ready to set up a cut.



Figure 1. ON/OFF Trigger.

Preparing For Operation

Before performing a cut, you will need to prepare the workpiece.

Check the type and the gauge of the material that will be cut. Make sure the capacity of the shears can handle the material to be cut.

Cutting Capacities:

- Up to 14 gauge sheet metal
- Up to 18 gauge stainless steel

Make sure that the workpiece is secure before starting the cut.

Swivel Head

The aluminum head on the Model H5503 is capable of rotating 360°.

To rotate the head of the shears:

1. Loosen the middle and rear setscrews (shown with arrows in **Figure 2**) on the side of the shear head.

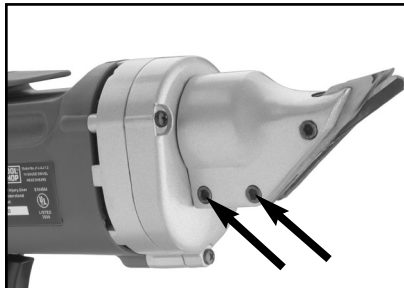

Figure 2. Loosening set screw.

2. Rotate the head until the desired position is reached, then tighten the setscrews.

Cutting

To start a cutting operation:

1. Choose a work space that is adequate for the size of material to be cut and secure the workpiece.
2. Layout the cut lines in your material with a scribe or writing utensil.
3. Start cutting at the edge of the workpiece as shown in **Figure 3**. You must apply forward pressure to begin cutting. **DO NOT** force shears through the workpiece.

When making an inside cut, drill a starting hole in the material. This will provide an interior starting edge to cut the material.



Figure 3. Starting at the edge.

Note—If everything is properly adjusted and in working order, there should be a spiral trail of sheet metal exiting the shear as you make your cut.

!WARNING

The removed spiral metal is sharp. **DO NOT** try to remove the metal from the workpiece by hand. Use heavy leather gloves when handling. Serious personal injury could occur.

Trigger Lock

The trigger lock allows you to cut without holding in the trigger.

!WARNING

Never start a cut with the trigger lock on. Only engage the trigger lock when the shears have entered and started cutting the workpiece. Serious personal injury and damage to the workpiece can occur.

To operate the trigger lock when cutting:

1. Begin cutting the material.
2. While cutting, press the trigger lock button into the handle as shown in **Figure 4**.
3. Continue cutting without holding down the trigger.
4. Squeeze in the trigger and the trigger lock will disengage.



Figure 4. Trigger Lock

Changing Blades

To change the blades:

1. Make sure the tool is disconnected from the power supply.
2. Unscrew the three cap screws in the head of the shears and set them aside.
3. Remove the head assembly from the main body of the shear by pulling it forward (**Figure 5**).



Figure 5. Shear head removal.

4. Remove the middle blade and side blades from the housing. Keep the spacer bushing for re-assembly.
5. Sharpen or replace the blades.
6. Install the blades back into the housing.

Note— Reassemble the blades back into the housing the same way they were taken out. Make note of their orientation.

7. Place the head around the gear box cover ring and tighten the cap screws to lock it into position.

MAINTENANCE

Lubrication

Always disconnect the power from the tool before performing any maintenance.

- Place one drop of light machine oil in the shear jaws (as shown in **Figure 6**) before every use. Wipe off any excess oil to avoid dust build-up.

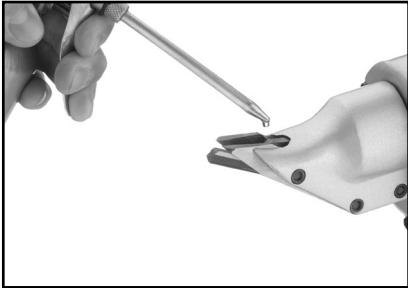

Figure 6. Lubricating shear.

- Place a few drops of heavy oil on the bearing assembly (**Figure 7**). Remove the gear box cover and lubricate the backside of the bearing assembly.

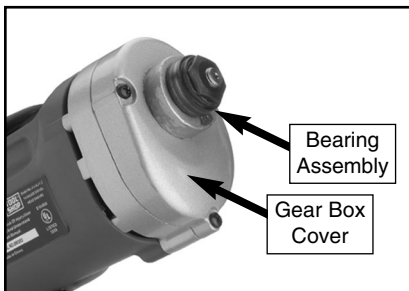

Figure 7. Bearing lubrication area.

Changing Motor Brushes

Carbon motor brushes are an important factor in maintaining quality power tool performance.

To change the motor brushes:

1. Remove the four screws in the handle cover (**Figure 8**).



Figure 8. Handle cover screws.

2. Remove the old motor brushes from the side of the motor casing (**Figure 9**).

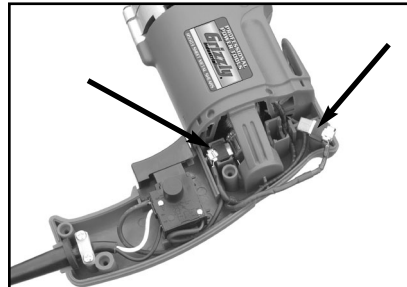

Figure 9. Carbon brushes.

3. Replace the carbon brushes and reattach the handle cover.

Basic Care

The following should be performed on the tool when applicable:

- Blow off dirt, dust and debris from the tool and out of the air vents.
- Maintain a sharp edge on your blades for the best performance.
- Clean the power cord and coil it neatly when the tool is not in use.
- Repair or replace damaged parts.
- Keep the blade safety cover on when the tool is not in use.

Cleaning Shear

Use a good solvent to clean the jaw assembly of the shear. Avoid getting solvent on the plastic body of the shear as it may damage the plastic. Always be sure that the shear is dry before using it again.

Do not allow dust, chips, sand, etc. into the air vent holes. This could lead to motor failure and premature bushing failure.

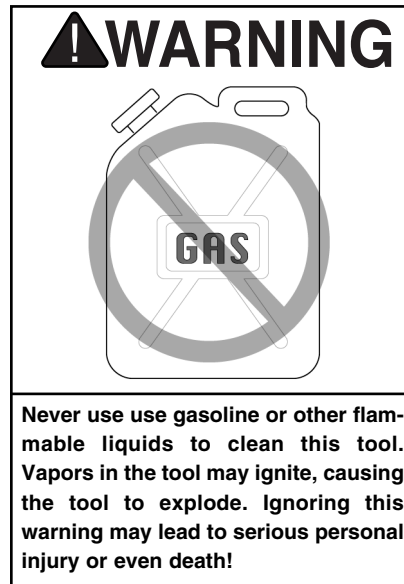

NOTES

H5503 14 Gauge Swivel Head Shears

-9-

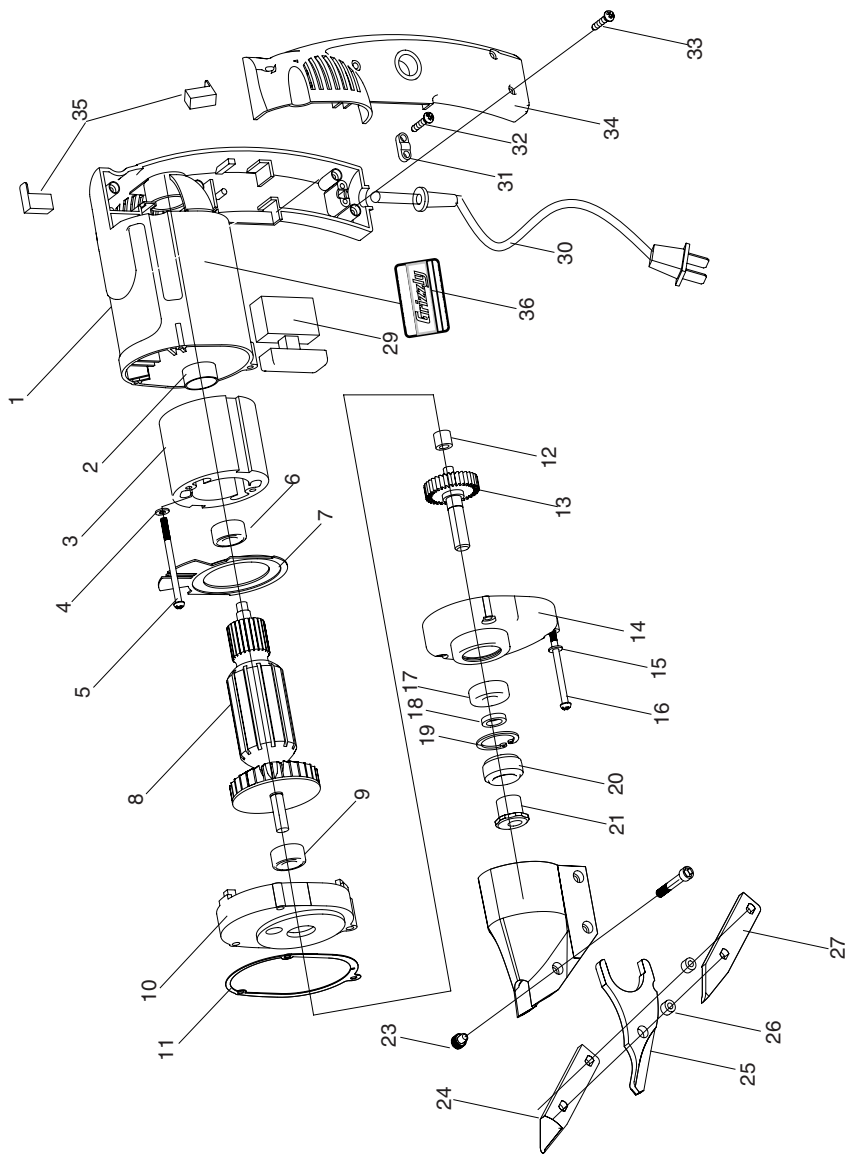

REF	PART #	DESCRIPTION
1	PH5503001	BODY COVER
2	PH5503002	BEARING STAND
3	PH5503003	STATOR
4	PW05M	FLAT WASHER 4MM
5	PH5503005	SPECIAL TAP SCREW M4-X 62
6	P607	BEARING 607Z
7	PH5503007	FAN COVER
8	PH5503008	ROTOR
9	PH5503009	BEARING STAND
10	PH5503010	GEAR BOX
11	PH5503011	SEALING MAT
12	P608ZZ	BEARING 608ZZ
13	PH5503013	GEAR BOX
14	PH5503014	COVER OF GEAR BOX
15	PH5503015	SPACER
16	PH5503016	SPECIAL TAP SCREW 4MM X42MM
17	P6000	BALL BEARING 6000ZZ
18	PH5503018	SPACER 11MM
19	PR46M	INT RETAINING RING 27
20	PH5503020	NEEDLE BEARING
21	PH5503021	CAM BEARING
22	PH5503022	BLADE HOUSING
23	PH5503023	SPECIAL NUT
24	PH5503024	BLADE
25	PH5503025	BLADE
26	PH5503026	BUSHING
27	PH5503027	BLADE
28	PH5503028	SPECIAL CAP SCREW
29	PH5503029	SWITCH
30	PH5503030	POWER CORD
31	PH5503031	BRACKET
32	PHTEK10	TAP SCREW 4MM X11MM
33	PHTEK8M	TAP SCREW M4 X 20
34	PH5503034	HANDLE
35	PH5503035	CARBON BRUSH (2)
36	PH5503036	GRIZZLY ID LABEL

WARRANTY AND RETURNS

Grizzly Industrial, Inc. warrants every product it sells for a period of **1 year** to the original purchaser from the date of purchase. This warranty does not apply to defects due directly or indirectly to misuse, abuse, negligence, accidents, repairs or alterations or lack of maintenance. This is Grizzly's sole written warranty and any and all warranties that may be implied by law, including any merchantability or fitness, for any particular purpose, are hereby limited to the duration of this written warranty. We do not warrant or represent that the merchandise complies with the provisions of any law or acts unless the manufacturer so warrants. In no event shall Grizzly's liability under this warranty exceed the purchase price paid for the product and any legal actions brought against Grizzly shall be tried in the State of Washington, County of Whatcom.

We shall in no event be liable for death, injuries to persons or property or for incidental, contingent, special, or consequential damages arising from the use of our products.

To take advantage of this warranty, contact us by mail or phone and give us all the details. We will then issue you a "Return Authorization Number," which must be clearly posted on the outside as well as the inside of the carton. We will not accept any item back without this number. Proof of purchase must accompany the merchandise.

The manufacturers reserve the right to change specifications at any time because they constantly strive to achieve better quality equipment. We make every effort to ensure that our products meet high quality and durability standards and we hope you never need to use this warranty.

Please feel free to write or call us if you have any questions about the machine or the manual.

Grizzly Industrial, Inc.
1203 Lycoming Mall Circle
Muncy, PA 17756
Phone: (570) 546-9663
Fax: (800) 438-5901

E-Mail:
techsupport@grizzly.com

Web Site: <http://www.grizzly.com>

Thank you again for your business and continued support. We hope to serve you again soon!

WARRANTY CARD

Name _____

Street _____

City _____ State _____ Zip _____

Phone Number _____ E-Mail _____ FAX _____

Model # _____ Order # _____

The following information is given on a voluntary basis. It will be used for marketing purposes to help us develop better products and services. Of course, all information is strictly confidential.

1. How did you learn about us?
 Advertisement Friend
 Catalog Card Deck
 World Wide Web
 Other _____
2. What is your annual household income?
 \$20,000-\$29,999 \$60,000-\$69,999
 \$30,000-\$39,999 \$70,000-\$79,999
 \$40,000-\$49,999 \$80,000-\$89,999
 \$50,000-\$59,999 \$90,000 +
3. What is your age group?
 20-29 50-59
 30-39 60-69
 40-49 70 +
4. How long have you been a woodworker?
 0 - 2 Years 8 - 20 Years
 2 - 8 Years 20+ Years
5. How would you rank your woodworking skills?
 Simple Advanced
 Intermediate Master Craftsman
6. What stationary woodworking tools do you own?
Check all that apply.
 Air Compressor Panel Saw
 Band Saw Planer
 Drill Press Power Feeder
 Drum Sander Radial Arm Saw
 Dust Collector Shaper
 Spindle Sander Jointer
 Table Saw Lathe
 Mortiser Wide Belt Sander
 Horiz.Boring Machine
 Vacuum Veneer Press
 Other _____
7. How many of your woodworking machines are Grizzly? _____
8. Which benchtop tools do you own? Check all that apply.
 1"x42" Belt Sander 6" - 8" Grinder
 5" - 8" Drill Press Mini Lathe
 8" Table Saw 8" - 10" Bandsaw
 Scroll Saw Disc/Belt Sander
 Spindle/Belt Sander Mini Jointer
 10"-12"Thickness Planer
 Other _____
9. How many of the machines checked above are Grizzly? _____
10. Which portable/hand held power tools do you own?
Check all that apply.
 Belt Sander Orbital Sander
 Biscuit Joiner Palm Sander
 Circular Saw Portable Planer
 Detail Sander Saber Saw
 Drill/Driver Reciprocating Saw
 Miter Saw Router
 Other _____
11. What machines/supplies would you like Grizzly Industrial to carry?

12. What new accessories would you like Grizzly Industrial to carry?

13. What other companies do you purchase your tools and supplies from?

14. Do you think your purchase represents good value?
 Yes No
15. Would you recommend Grizzly to a friend?
 Yes No
16. Would you allow us to use your name as a reference for Grizzly customers in your area? **Note: We never use names more than three times.**
 Yes No
17. Comments: _____

Send a Grizzly Catalog to a friend:

Name _____
Street _____
City _____ State _____ Zip _____

FOLD ALONG DOTTED LINE

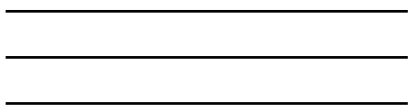

Place
Stamp
Here



GRIZZLY INDUSTRIAL, INC.
P.O. BOX 2069
BELLINGHAM, WA 98227-2069



TAPE ALONG EDGES--PLEASE DO NOT STAPLE

Free Manuals Download Website

<http://myh66.com>

<http://usermanuals.us>

<http://www.somanuals.com>

<http://www.4manuals.cc>

<http://www.manual-lib.com>

<http://www.404manual.com>

<http://www.luxmanual.com>

<http://aubethermostatmanual.com>

Golf course search by state

<http://golfingnear.com>

Email search by domain

<http://emailbydomain.com>

Auto manuals search

<http://auto.somanuals.com>

TV manuals search

<http://tv.somanuals.com>