

HKTS 60BQ

Home theater speaker system

Owner's Manual



harman/kardon[®]
by HARMAN

Important Safety Instructions

1. Read these instructions.
2. Keep these instructions.
3. Heed all warnings.
4. Follow all instructions.
5. Do not use this apparatus near water.
6. Clean only with a dry cloth.
7. Do not block any ventilation openings. Install in accordance with the manufacturer's instructions.
8. Do not install near any heat sources such as radiators, heat registers, stoves or other apparatus (including amplifiers) that produce heat.
9. Do not defeat the safety purpose of the polarized or grounding-type plug. A polarized plug has two blades with one wider than the other. A grounding-type plug has two blades and a third grounding prong. The wide blade or the third prong is provided for your safety. If the provided plug does not fit into your outlet, consult an electrician for replacement of the obsolete outlet.
10. Protect the power cord from being walked on or pinched, particularly at plugs, convenience receptacles and the point where they exit from the apparatus.
11. Only use attachments/accessories specified by the manufacturer.
12. Use only with the cart, stand, tripod, bracket or table specified by the manufacturer or sold with the apparatus.  When a cart is used, use caution when moving the cart/apparatus combination to avoid injury from tip-over.
13. Unplug this apparatus during lightning storms or when unused for long periods of time.
14. Refer all servicing to qualified service personnel. Servicing is required when the apparatus has been damaged in any way, such as power supply cord or plug is damaged, liquid has been spilled or objects have fallen into the apparatus, or the apparatus has been exposed to rain or moisture, does not operate normally or has been dropped.
15. Do not expose this apparatus to dripping or splashing and ensure that no objects filled with liquids, such as vases, are placed on the apparatus.
16. To completely disconnect this apparatus from the AC Mains, disconnect the power supply cord plug from the AC receptacle.
17. The mains plug of the power supply cord shall remain readily operable.
18. Do not expose batteries to excessive heat such as sunshine, fire or the like.

	<p>CAUTION RISK OF ELECTRIC SHOCK DO NOT OPEN</p>	
<p>THE LIGHTNING FLASH WITH AN ARROWHEAD SYMBOL, WITHIN AN EQUILATERAL TRIANGLE, IS INTENDED TO ALERT THE USER TO THE PRESENCE OF UNINSULATED "DANGEROUS VOLTAGE" WITHIN THE PRODUCT'S ENCLOSURE THAT MAY BE OF SUFFICIENT MAGNITUDE TO CONSTITUTE A RISK OF ELECTRIC SHOCK.</p>	<p>WARNING: TO REDUCE THE RISK OF FIRE OR ELECTRIC SHOCK, DO NOT EXPOSE THIS APPARATUS TO RAIN OR MOISTURE.</p>	<p>THE EXCLAMATION POINT WITHIN AN EQUILATERAL TRIANGLE IS INTENDED TO ALERT THE USER TO THE PRESENCE OF IMPORTANT OPERATING AND MAINTENANCE (SERVICING) INSTRUCTIONS IN THE LITERATURE ACCOMPANYING THE PRODUCT.</p>
<p>SEE MARKING ON BACK OF PRODUCT.</p>		

Harman Kardon® HKTS 60

Typographical Conventions

We have employed certain conventions to help you use this manual:

① – (number in a circle) – Indicates a rear-panel control or connection on the illustration of the HKTS200SUB subwoofer

Example (bold type) – Indicates the name of a specific control or rear-panel connection on the HKTS200SUB subwoofer

EXAMPLE (OCR type) – Indicates a control or switch setting on the HKTS200SUB subwoofer

Thank you for purchasing the Harman Kardon® HKTS 60 speaker system, with which you're about to begin many years of listening enjoyment. The HKTS 60 has been custom designed to provide all the excitement and power of the cinema experience in your own living room.

While sophisticated electronics and state-of-the-art speaker components are hard at work within the HKTS 60, hookup and operation are easy, thanks to simple controls and color-keyed cables and connections.

To obtain maximum enjoyment from your new home theater speaker system, we urge you to take a few minutes to read through this manual. It will help ensure that the connections you make to your receiver (or preamp/processor), amplifier and other devices are correct. In addition, a few minutes spent learning the functions of the various controls will enable you to take advantage of all the power and refinement the HKTS 60 is able to deliver.

If you have any questions about this product, its installation or its operation, please contact your dealer, the best local source of information.

Description and Features

The HKTS 60 is a complete six-piece home theater speaker system that includes:

- An 8-inch, 200-watt powered subwoofer
- Four identical, two-way, video-shielded, dual-driver satellite speakers for the front left and front right, and rear left and rear right (surround) speaker positions
- A dedicated, voice-matched, video-shielded, dual-driver center speaker
- Removable bases and wall-mount brackets for the satellite speakers and a wall-mount bracket for the center speaker
- All of the cables you need to connect all of the speakers to your receiver or preamp/processor and amplifier.

The speaker cables all use a color-coding system to conform to the Consumer Electronics Association (CEA®) standard. This color-coding system minimizes confusion when connecting the speakers, especially when you are connecting them to a Harman Kardon receiver.

We have equipped the HKTS200SUB subwoofer with a special input (labeled LFE) that simplifies connection to receivers and preamp/processors with dedicated subwoofer outputs that carry low-frequency signals. Other conveniences include a level control, a phase switch for fine-tuning bass response to suit your listening environment and taste, and an efficient switching system that senses the presence of an audio signal and automatically switches the subwoofer from standby mode to on.

We have included wall-mount brackets for the satellite and center speakers and shelf stands for the satellite speakers. Optional HKFS 3 floorstands are available separately from your Harman Kardon dealer.

Harman Kardon invented the high-fidelity receiver fifty years ago. With state-of-the-art features and time-honored circuit designs, the HKTS 60 is a perfect complement to a Harman Kardon receiver or any home theater system.

Included

Four satellite speakers for front left/right and surround left/right

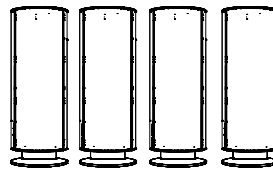

One center speaker

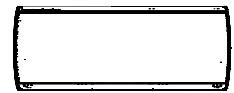

One powered subwoofer

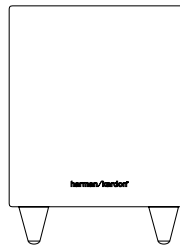

Four wall-mount brackets for satellite speakers

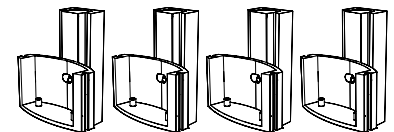

One wall-mount bracket for center speaker

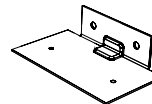

Four metal stop plates and screws (for satellite speaker wall-mount brackets)

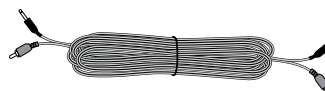
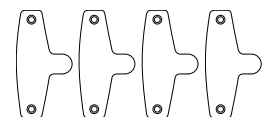

One combination LFE and trigger cable for connection to the subwoofer (LFE cable has purple connectors)

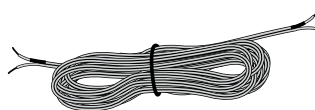

One 4-meter (13.1-foot) speaker cable for center speaker (green color bands)

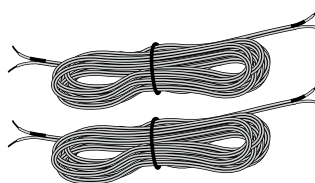

Two 5-meter (16.4-foot) speaker cables for front satellites (red and white color bands)

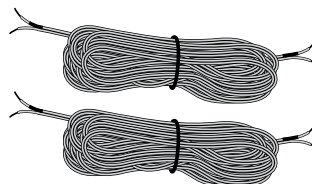

Two 10-meter (32.8-foot) speaker cables for rear satellites (gray and blue color bands)

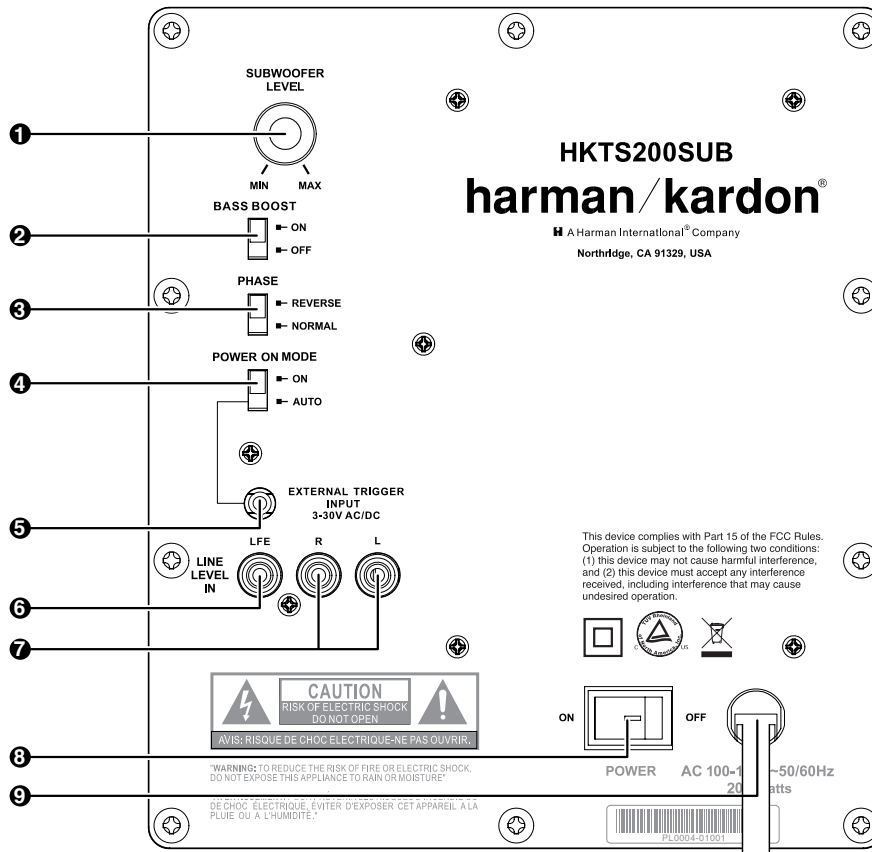

- 1 **Subwoofer Level Control:** Use this control to adjust the HKTS200SUB's volume. Turn clockwise to increase the volume; turn counterclockwise to decrease the volume.
- 2 **Bass Boost Switch:** Set this switch to **ON** to enhance the HKTS200SUB's low-frequency performance. Set this switch to **OFF** for normal low-frequency performance.
- 3 **Phase Switch:** This switch determines whether the HKTS200SUB's piston-like action moves in and out in phase with the satellite speakers. If the subwoofer were to play out of phase with the satellite speakers, the sound waves from the satellites could cancel out some of the subwoofer's sound waves, reducing bass performance and sonic impact. This phenomenon depends in part on the placement of all the speakers in the room. In most cases the **Phase Switch** 3 should be left in the **NORMAL** position. However, it does no harm to experiment, and you can leave the **Phase Switch** 3 in the position that maximizes bass response and impact.
- 4 **Power On Mode Switch:** When this switch is set in the **AUTO** position and when the **Power Switch** 8 is set to **ON**, the HKTS200SUB will automatically turn itself on when it receives an audio signal and will enter the standby mode after it has received no audio signal for about 15 minutes. When this switch is set in the **ON** position, the HKTS200SUB will remain on whether or not it is receiving an audio signal. An LED light on the HKTS200SUB's top panel indicates whether the subwoofer is in the on or standby state:
 - When the LED is illuminated white, the HKTS200SUB is turned on.
 - When the LED is not illuminated, the HKTS200SUB is in standby mode. When the **Power Switch** 8 is set to **OFF**, the LED will not be illuminated, no matter what setting the **Power On Mode Switch** 4 is in.
- 5 **External Trigger Input:** Use the mini-plug of the supplied combination LFE and trigger cable to connect the **External Trigger Input** to the trigger output of another compatible component. Whenever the HKTS200SUB's amplifier detects a trigger signal between 3V and 30V (AC or DC), the amplifier will turn on. The amplifier will turn off after the trigger signal ceases, even when the **Power On Mode Switch** 4 is in the **AUTO** position.
- 6 **Line-Level LFE In Connector:** Use the LFE (purple) connector of the supplied combination LFE and trigger cable to connect the **Line-Level LFE In Connector** 6 to the dedicated subwoofer output of a receiver or preamp processor. This input bypasses the HKTS200SUB's internal crossover circuitry, so use it only with a subwoofer output that has been low-pass filtered. If your receiver or preamp/processor does not have a dedicated subwoofer output that is low-pass

- filtered, use the HKTS200SUB's **Line-Level L/R In Connectors** 7 instead.
- 7 **Line-Level L/R In Connectors:** Use these connectors if your receiver or pre-amp/processor does not have digital surround-sound decoding or a subwoofer output that is low-pass filtered.
 - If your receiver or preamp/processor has a separate subwoofer output, use the LFE (purple) connector of the supplied combination LFE and trigger cable to connect it to either one of the HKTS200SUB's **Line-Level L/R In Connectors**.
 - If your receiver or preamp/processor does not have a separate subwoofer output, use two Y-adapters (not supplied). Connect an adapter's single end to the unit's preamp output for that channel. Connect one of the adapter's dual ends to the main amp input for that channel, and connect the adapter's other dual end to one of the HKTS200SUB's **Line-Level L/R In Connectors**. Repeat the process with the other Y-adapter, preamp channel, main amp input and HKTS200SUB **Line-Level L/R In Connector**.
 - 8 **Power Switch:** Set this switch in the **ON** position to turn the HKTS200SUB on. The subwoofer will then be either on or in standby mode, depending on the setting of the **Power On Mode Switch** 4.
 - 9 **Power Cord (Non-Detachable):** After you have made and verified all subwoofer and speaker connections described in this manual, plug this cord into an active, *unswitched* electrical outlet for proper operation of the HKTS200SUB. DO NOT plug this cord into the accessory outlets found in some audio components.

Color-Coding System

The HKTS 60 uses the channel color-coding system established by the CEA to make setting up your home theater speaker system as easy as possible. The HKTS 60 system includes speaker wires with color bands on each end.

Speaker Position	Wire Color Band
Front Left	White
Front Right	Red
Center	Green
Surround Left	Blue
Surround Right	Gray
Subwoofer	Purple

Placing the Front Speakers

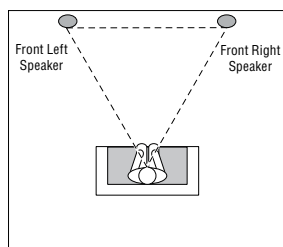

Place the front speakers the same distance from each other as they are from the listener's position. Place them at about the same height from the floor as the listener's ears will be. They also can be angled toward the listener.

Placing the Center Speaker

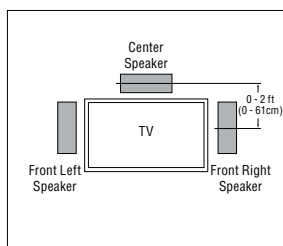

Place the center speaker slightly behind the front left and front right speakers (farther away from the listener). Its center should be no more than two feet (61cm) above or below the tweeters of the front left and front right speakers. If you have a CRT television (that is, not a flat screen), it may be convenient to set the center speaker on top of the television set.

Placing the Subwoofer

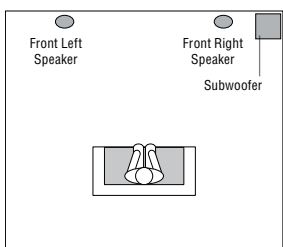

Since our ears do not hear directional sound at the low frequencies where the subwoofer operates, it will perform well from just about any location in your room. However, you are likely to hear the best bass reproduction when the subwoofer is placed in a corner along the same wall as the front left and front right speakers. You can experiment with subwoofer placement by temporarily placing the subwoofer in the listening position and playing music with strong bass content. Move around to various locations in the room while the system is playing, and listen until you find the location where the bass performance is best. Place the subwoofer in that location.

Placing the Surround Speakers

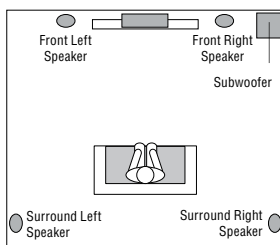
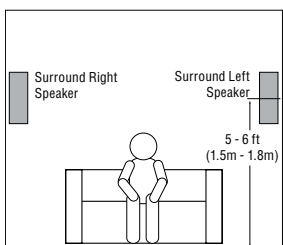

The two surround speakers should be placed slightly behind the listening position, facing each other, and, ideally, should be 5 – 6 feet (1.5m – 1.8m) from the floor. An alternate location would be on a wall behind the listening position, facing forward. The surround speakers should not call attention to themselves while they're playing. Experiment with their placement until you hear a diffuse, ambient sound accompanying the program material heard from the front left, front right and center speakers.

Mounting Options for Satellite and Center Speakers

Shelf Placement

You can place the satellite and center speakers on shelves. The satellite speakers have built-in bases for shelf placement. You can also remove the bases.

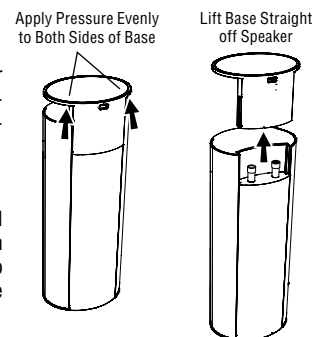

To remove a satellite speaker's base, pull it straight off the speaker, as shown in the illustration. Applying even pressure to both sides of the base will allow it to slide off smoothly.

Wall-Mounting: Satellite Speakers

IMPORTANT: Read the *Speaker Connections* section, on page 7, before wall-mounting the satellite speakers. You will need to insert the speaker wires through the wall-mount brackets and connect the wires to the speakers during the process of installing the brackets.

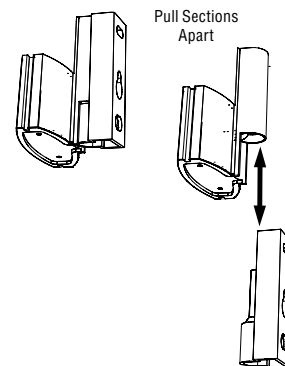

NOTE: If you are using your own speaker wire, it must be no thicker than the wire supplied with the speakers. Thicker wire will prevent the bracket from sliding onto the speaker.

1. Decide on the location for the speaker.
2. Remove the speaker's base as explained in *Shelf Placement*, above.
3. Disassemble the wall-mount bracket by sliding the two sections apart, as shown in the illustration.
4. Attach the wall portion of the wall-mount bracket onto the wall using hardware that is appropriate for the wall's construction and materials. We recommend first anchoring the bracket using its keyhole, then attaching it with another anchor through its top opening, as shown in the illustration. Note that the satellite speakers weigh 3.4 lb (1.55kg). Be sure to use hardware that can support this weight.

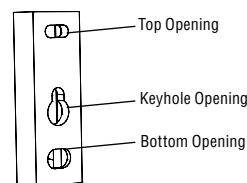

NOTE: If you're running the speaker wire through the wall, you can bring it out directly behind the bracket location and insert it through the bottom opening in the wall portion of the bracket, as shown in the illustration. Running the wire in this way will keep the wire completely hidden from view once the installation is complete.

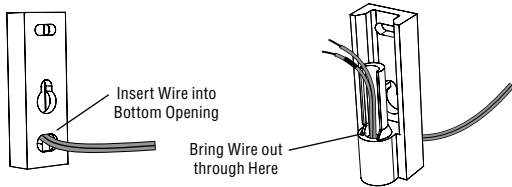

5. If you're not running the speaker wire through the wall, insert it through the wall portion of the bracket, as shown in the illustration.

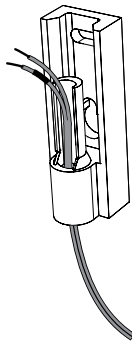

6. Pass the speaker wire through the speaker portion of the wall-mount bracket, as shown in the illustration.

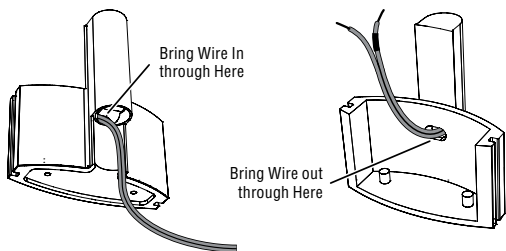

7. If you have not already removed the speaker's base, do so by pulling it straight off the speaker, as shown in the illustration. Applying even pressure to both sides of the base will allow it to slide off smoothly.

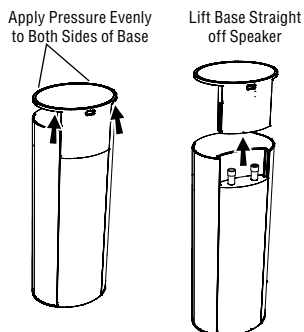

CAUTION: Before making speaker connections, be sure that your receiver or amplifier is turned OFF and its AC cord is unplugged from the AC outlet.

8. Connect the speaker wire to the speaker terminals as shown in the illustration:

- Press down on the top of the terminal to open the connection hole.
- Insert the wire's bare end all the way into the hole.
- Release the terminal to secure the wire.

Insert the conductor with the colored band into the speaker's *red* (+) terminal, and insert the other conductor into the speaker's *black* (-) terminal.

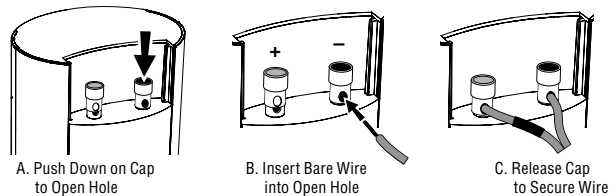

IMPORTANT: Make sure the (+) and (-) bare wires do not touch each other or the other terminal. Touching wires can cause a short circuit that can damage your receiver or amplifier.

9. Slide the speaker portion of the wall-mount bracket onto the speaker as shown in the illustration. Fit the grooves on the bracket onto the rails in the speaker, and apply even pressure on both sides of the bracket so it slides straight onto the speaker.

- Push the bracket all the way onto the speaker until it snaps into place.
- Pull any slack speaker wire back through the bracket as you slide the bracket onto the speaker.

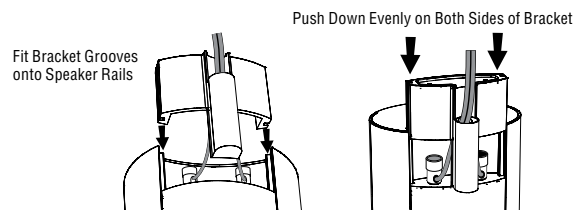

10. Slide the speaker onto the bracket's wall section, as shown in the illustration. Pull any slack speaker wire back through the bracket's wall section.

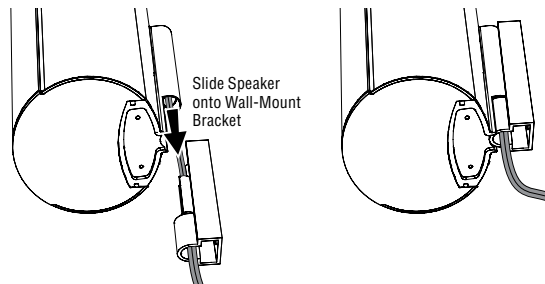

11. Fit the metal stop plate into the recess on the bottom of the bracket with the pad facing the bracket, and fasten it to the bracket using two of the supplied screws. Fastening it will prevent the speaker from detaching from the bracket and will hold the speaker's position as you rotate it.

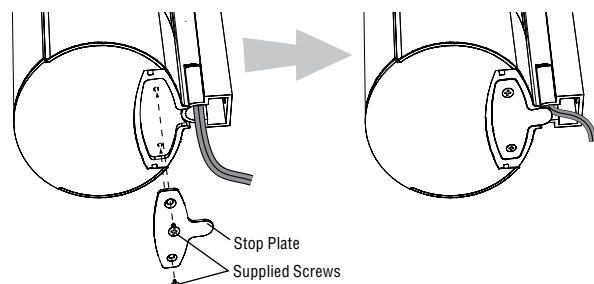

Wall-Mounting: Center Speaker

1. Decide on the location for the speaker.
2. Attach the center speaker wall-mount bracket to the wall using hardware that is appropriate for the wall's construction and materials. Attach the anchors through the holes shown in the illustration.

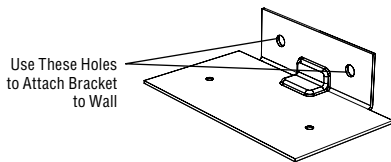

NOTE: The center speaker weighs 3.3 lb (1.5kg). Be sure to use hardware that can support this weight.

CAUTION: Before making speaker connections, be sure that your receiver or amplifier is turned OFF and its AC cord is unplugged from the AC power source.

3. Connect the speaker wire to the speaker terminals. Press down on the top of the terminal to open the connection hole, insert the wire's bare end all the way into the hole and release the terminal to secure the wire. Insert the conductor with the colored band into the speaker's *red* (+) terminal, and insert the other conductor into the speaker's *black* (-) terminal, as shown in the illustration.

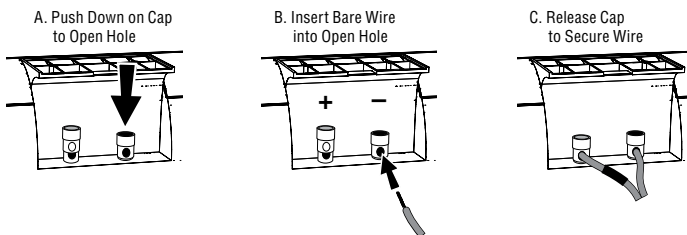

Important: Make sure the (+) and (-) bare wires do not touch each other or the other terminal. Touching wires can cause a short circuit that can damage your receiver or amplifier.

4. Using two of the supplied screws, attach the center speaker to the bracket, as shown in the illustration.

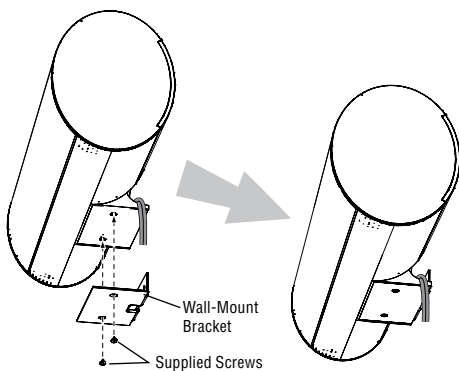

Speaker Connections

CAUTION: Before making speaker connections, be sure that your receiver or amplifier is turned OFF and its AC cord is unplugged from the AC power outlet.

Speakers and receivers/amplifiers have corresponding (+) and (-) connection terminals. Most electronics manufacturers, including Harman Kardon, use *red* to denote the (+) terminal and *black* for the (-) terminal. Newer Harman Kardon receivers conform to the CEA standard and therefore use a color other than red to denote the (+) terminal for some speaker positions. See the table in *Color-Coding System*, on page 4.

Each speaker wire included with your system has colored bands at both ends of the (+) conductor, and the subwoofer cable has purple connectors that correspond to the color of the HKTS200SUB's LFE jack. This system helps ensure that the speaker in each location is connected to the correct receiver or amplifier terminals. In addition to the colored bands at each end, each speaker wire's (+) terminal has ribs molded into its insulation to help you identify it.

It is very important to connect each speaker identically: (+) on the speaker to (+) on the receiver or amplifier, and (-) on the speaker to (-) on the receiver or amplifier. Miswiring one or more speakers results in thin sound, weak bass and a poor stereo image. With the advent of multichannel surround-sound systems, connecting all of the speakers in your system correctly is very important to achieving the proper ambience and directionality of the program material.

To connect the speaker wire to the terminals on the satellite and center speakers, press down on the top of the terminal to open the connection hole, insert the wire's bare end all the way into the hole, and release the terminal to secure the wire. Insert the conductor with the colored band into the speaker's *red* (+) terminal, and insert the other conductor into the speaker's *black* (-) terminal, as shown in the illustration.

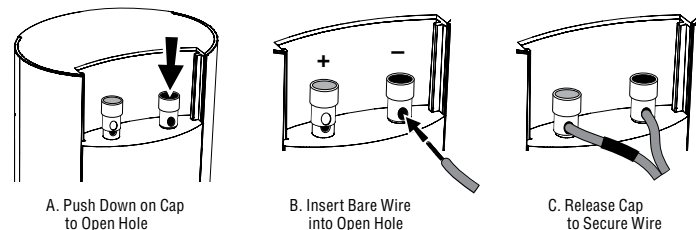

IMPORTANT: Make sure the (+) and (-) bare wires do not touch each other or the other terminal. Touching wires can cause a short circuit that can damage your receiver or amplifier.

Connecting Satellite Speakers With Supplied Wall-Mount Brackets

Follow the instructions in *Wall-Mounting: Satellite Speakers*, on page 5, and *Wall-Mounting: Center Speaker*, opposite.

Connecting Satellite Speakers with Supplied Bases

1. Remove the speaker's base (see *Shelf Placement*, on page 5).
2. Pass the speaker wire through the opening in the speaker's base.
3. Connect the speaker wire as described above.
4. Reattach the speaker's base, as shown in the illustration.

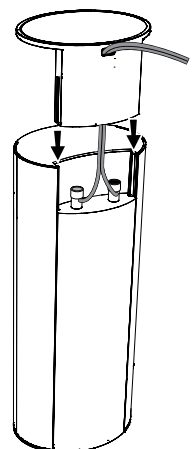

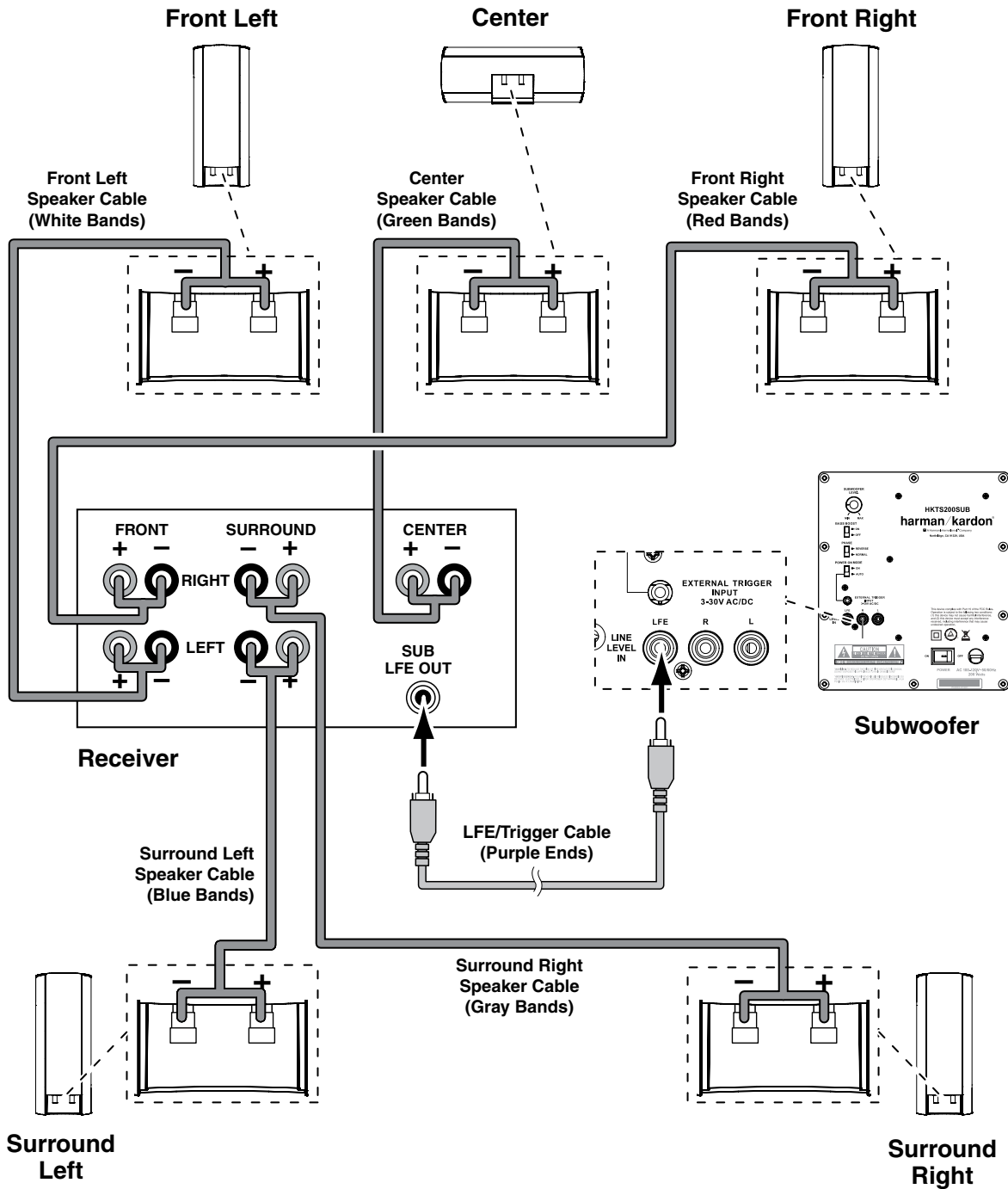

Connecting the Subwoofer to a Receiver or Preamp/Processor With a Dedicated Subwoofer Output

Use this installation method for receivers and preamp/processors that have a dedicated subwoofer output with low-pass filtering (also called bass management). If the dedicated subwoofer output does not have low-pass filtering, follow the instructions in *Connecting the Subwoofer to a Receiver or Preamp/Processor With Line Outputs*, on page 9.

Use the LFE (purple) connector of the supplied combination LFE and trigger cable to connect the HKTS200SUB's **Line-Level LFE In Jack** ⑥ to the dedicated subwoofer output (or LFE output) of your receiver or preamp/processor.

Connect each satellite speaker and the center speaker to the corresponding speaker terminals on your receiver or amplifier.

Configure your receiver or preamp/processor's setup menu for *Subwoofer ON*, and set the front left, front right, center and surround speakers to *Small*. After you have made and verified all connections, plug the HKTS200SUB's **AC Power Cord** ⑨ into an active AC outlet.

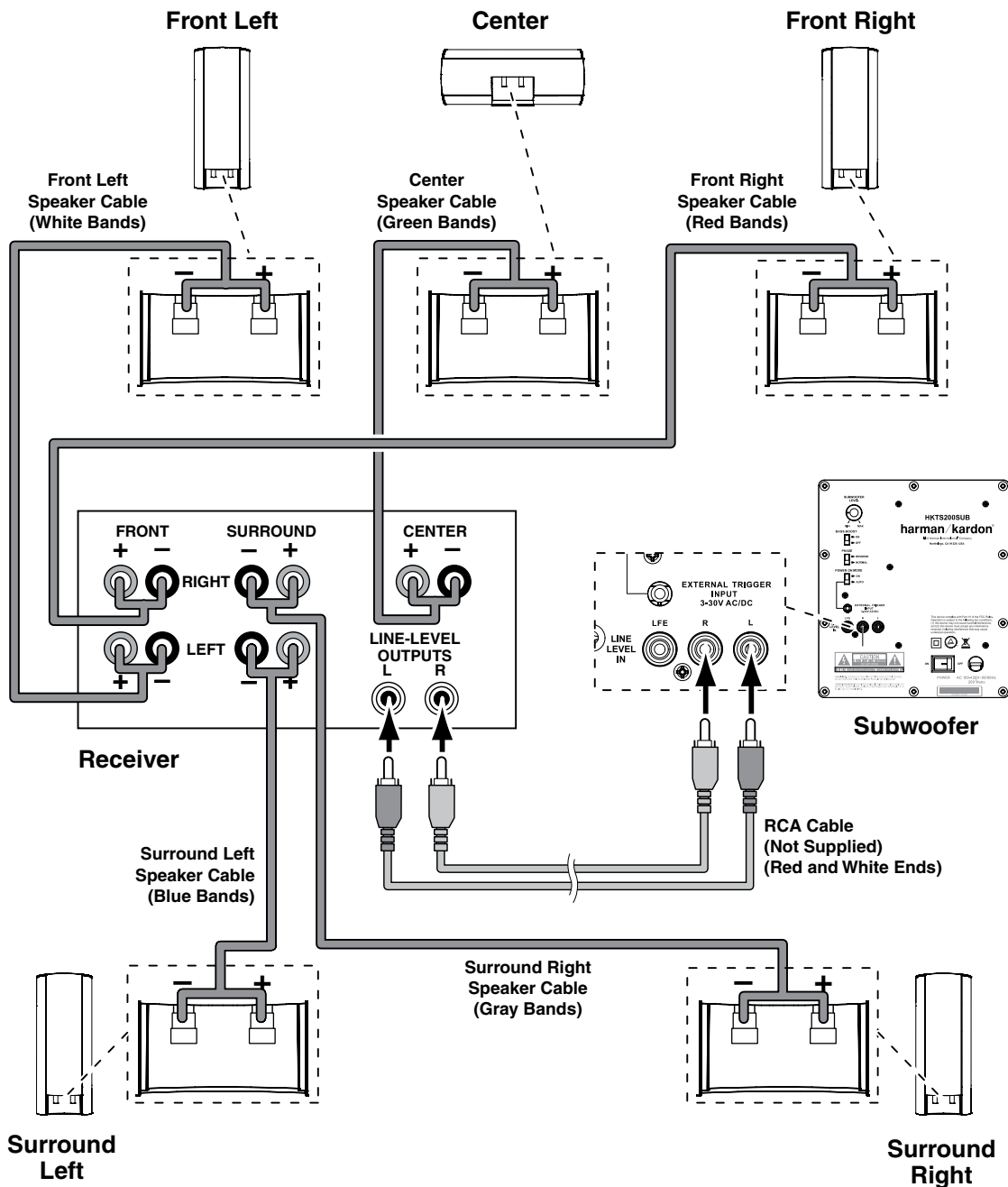

Connecting the Subwoofer to a Receiver or Preamp/Processor With Line Outputs

Use this installation method for receivers and preamp/processors that do not have a dedicated subwoofer output but do have preamp-level (volume-controlled) line outputs. If the receiver or preamp/processor has a dedicated subwoofer output with low-pass filtering, see *Connecting the Subwoofer to a Receiver or Preamp/Processor With a Dedicated Subwoofer Output*, on page 8.

If you're connecting to a receiver with left and right line outputs that are not connected to amplifier inputs, connect the LFE (purple) connector of the supplied combination LFE and trigger cable to one of those outputs and to either of the HKTS200SUB's **Line-Level L/R In Connectors** 7. Use a second RCA cable (not supplied) to connect the other receiver or preamp line output to the other of the HKTS200SUB's **Line-Level L/R In Connectors** 7.

If you're connecting to a receiver or preamp/processor with left and right line outputs that are connected to amplifier front left and front right inputs, connect

the single line outputs. Connect one of the Y-adapter's double ends to the HKTS200SUB's **Line-Level L/R In Connectors** 7, and connect the other double end to your amplifier's front left and right inputs.

Connect each satellite speaker and the center speaker to the corresponding speaker terminals on your receiver or amplifier.

Configure your receiver or preamp/processor's setup menu for *Subwoofer ON*, and set the front left, front right, center and surround speakers to *Small*.

After you have made and verified all connections, plug the HKTS200SUB's **AC Power Cord** 9 into an active AC outlet.

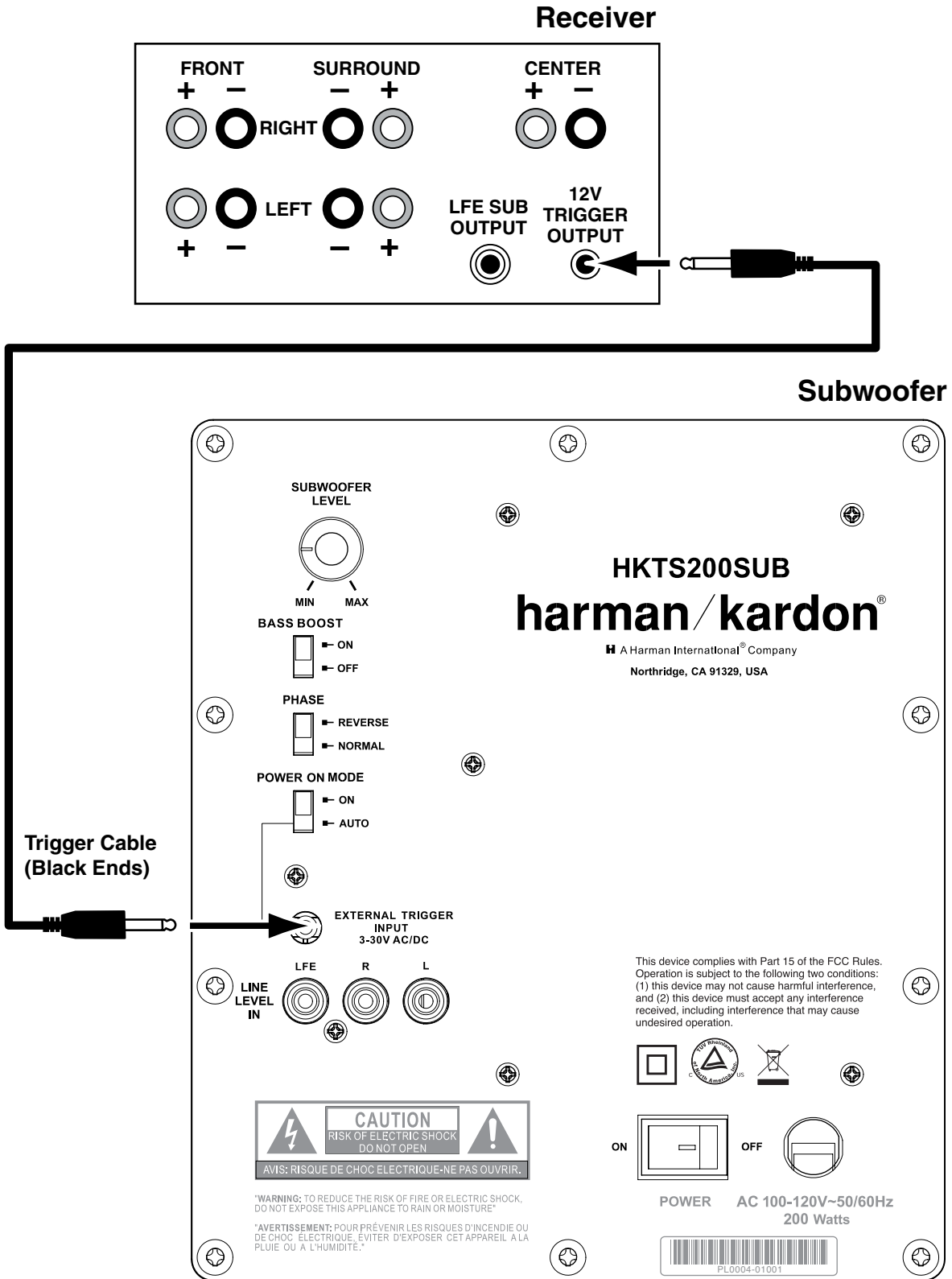

Connecting to a Trigger-Voltage Source

If your preamp/processor or another audio/video component has a trigger-voltage connection that supplies between 3V and 30V (AC or DC), connect it to the HKTS-200SUB's **External Trigger Input** ⑤. If the component's trigger-voltage connection has a 3.5mm mini jack, you can use the supplied combination LFE/trigger cable to make the connection.

NOTE: Please do not connect the subwoofer ON/OFF trigger cable to the Remote Control Output (IR Out) of your home cinema system or surround receiver. Doing so could lead to malfunction.

Operation

Turning the Subwoofer On and Off

Set the HKTS200SUB's **Power Switch ③** to the **ON** position.

- If the **Power On Mode Switch ④** is set to **AUTO**, the HKTS200SUB will automatically turn itself on when it receives an audio signal, and it will go into standby mode after it has received no audio signal for 15 minutes. The HKTS-200SUB's LED will glow white when the subwoofer is on, and will not be illuminated when the subwoofer is in standby.
- If the **Power On Mode Switch ④** is set to **ON**, the HKTS200SUB will remain on at all times. The HKTS200SUB's LED will glow white.
- If the **External Trigger Input ⑤** is connected to a trigger voltage source, the HKTS200SUB will turn on whenever a trigger voltage is present, and will turn off after the trigger voltage ceases, regardless of the position of the **Power On Mode Switch ④**.

If you will be away from home for an extended period of time, or if you will not be using the subwoofer for an extended period, switch the **Power Switch ③** to the **OFF** Position.

Subwoofer Adjustments: Volume

Use the **Subwoofer Level Control ①** to set the HKTS200SUB's volume. Turn the knob clockwise to increase the subwoofer's volume; turn the knob counterclockwise to decrease the subwoofer's volume.

Subwoofer Adjustments: Phase

The **Phase Switch ②** determines whether the HKTS200SUB's piston-like action moves in and out in phase with the satellite speakers. If the subwoofer were to play out of phase with the satellite speakers, the sound waves from the satellites could cancel out sound waves from the subwoofer, reducing bass performance and sonic impact. This phenomenon depends in part on the placement of all the speakers in the room.

Although in most cases the **Phase Switch ②** should be left in the **NORMAL** position, there is no absolutely correct setting for the **Phase Switch ②**. When the HKTS200SUB is properly in phase with the satellite speakers, the audio will be clearer, have maximum impact and make percussive sounds like drums, piano and plucked strings sound more lifelike. The best way to set the **Phase Switch ②** is to listen to music that you know well and set the switch in the position that gives drums and other percussive sounds maximum impact.

Subwoofer Adjustments: Bass Boost

When set to the **ON** position, the **Bass Boost Switch ④** enhances low-frequency performance, resulting in bass with more impact, which you may prefer while watching movies or listening to music. There is no harm in experimenting with this control. Setting the switch to the **OFF** position will return normal low-frequency performance.

Troubleshooting

This unit is designed for trouble-free operation. Most problems that users encounter are due to operating errors. So if you have a problem, first check this list for a possible solution. If the problem persists, consult your authorized Harman Kardon service center.

Problem	Solution
If there is no sound from <i>any</i> of the speakers:	<ul style="list-style-type: none"> • Check that the receiver/amplifier is on and a source is playing. • Make sure that all wires and connections between the receiver/amplifier and the speakers are connected properly. • Make sure that the speaker wires are not frayed, cut or punctured. • Review the proper operation of your receiver/amplifier.
If there is no sound coming from <i>one</i> of the speakers:	<ul style="list-style-type: none"> • Check that the balance control on your receiver/amplifier is not set all the way to one channel. • Check your receiver/amplifier's speaker setup procedure to make sure that the speaker in question has been enabled and its volume level has not been turned all the way down. • Make sure that all wires and connections between the receiver/amplifier and the speaker are connected properly. • Make sure that the speaker wires are not frayed, cut or punctured.
If there is no sound coming from the center speaker:	<ul style="list-style-type: none"> • Check your receiver/amplifier's speaker setup procedure to make sure that the center speaker has been enabled and its volume level has not been turned all the way down. • Make sure that all wires and connections between the receiver/amplifier and the center speaker are connected properly. • Make sure that the speaker wires are not frayed, cut or punctured. • If your receiver is operating in Dolby® Pro Logic® mode, make sure that the center speaker is not set to Phantom.

You can find additional troubleshooting information in the FAQs link on the Support page at www.harmankardon.com.

Specifications

HKTS 60 System

Frequency response	45Hz – 20kHz (–6dB)
--------------------	---------------------

SAT-TS60 Satellites

Recommended power	20 ~ 150 watts
Impedance	8 ohms nominal
Sensitivity	83dB @ 2.83V/1 meter
Tweeter	One 1" (25mm) CMMD® Lite dome, video-shielded
Midrange	Dual 3" (75mm) flat-diaphragm drivers, video-shielded
Dimensions – including stands (H x W x D)	11-25/32" x 4-11/32" x 3-15/32" (299mm x 110mm x 88mm)
Weight	3.4 lb (1.55kg)

CEN-TS60

Recommended power	20 ~ 150 watts
Impedance	8 ohms nominal
Sensitivity	83dB @ 2.83V/1 meter
Tweeter	One 1" (25mm) CMMD Lite dome, video-shielded
Midrange	Dual 3" (75mm) flat-diaphragm drivers, video-shielded
Dimensions – including stands (H x W x D)	4-11/32" x 10-11/32" x 3-15/32" (110mm x 272mm x 88mm)
Weight	3.3 lb (1.5kg)

HKTS200SUB Subwoofer

Input rating	AC 100 – 120V, 50/60Hz, 200W
Amplifier power	200 watts RMS
Bass	8" woofer, sealed enclosure
External trigger input voltage	3 ~ 30 volts AC/DC
Dimensions (H x W x D)	13-29/32" x 10-1/2" x 10-1/2" (353mm x 267mm x 267mm)
Weight	19.8 lb (9kg)

HARMAN

Harman Consumer, Inc.
8500 Balboa Boulevard, Northridge, CA 91329 USA
516.255.4545 (USA only)

Made in P.R.C.

© 2010 Harman International Industries, Incorporated. All rights reserved.

Features, specifications and appearance are subject to change without notice. Harman Kardon and CMMD are trademarks of Harman International Industries, Incorporated, registered in the United States and/or other countries.

CEA is a registered trademark of the Consumer Electronics Association.

Dolby and Pro Logic are registered trademarks of Dolby Laboratories.

DTS is a registered trademark of Digital Theater Systems, Inc.

Part # 950-0302-001



harman/kardon®

www.harmankardon.com

Free Manuals Download Website

<http://myh66.com>

<http://usermanuals.us>

<http://www.somanuals.com>

<http://www.4manuals.cc>

<http://www.manual-lib.com>

<http://www.404manual.com>

<http://www.luxmanual.com>

<http://aubethermostatmanual.com>

Golf course search by state

<http://golfingnear.com>

Email search by domain

<http://emailbydomain.com>

Auto manuals search

<http://auto.somanuals.com>

TV manuals search

<http://tv.somanuals.com>