

Models:  
CARODG36I  
CARODG36IL  
CARODG42I  
CARODG42IL

GAS-FIRED



**CAUTION**



**DO NOT DISCARD THIS MANUAL**

Important operating and maintenance instructions included. • Read, understand and follow these instructions for safe installation and operation. • Leave this manual with party responsible for use and operation.



**⚠ DANGER**

If you smell gas:

1. Shut off gas to the appliance.
2. Extinguish any open flame.
3. If odor continues, keep away from the appliance and immediately call your gas supplier or fire department.

**⚠ WARNING**



**HOT SURFACES!**

Screens and other surfaces are hot during operation and cool down.

**Hot screens will cause burns.**

- Do not touch fireplace until it is cooled
  - NEVER allow children to touch fireplace
  - Keep children away
- CAREFULLY SUPERVISE children in same area as fireplace.
  - Alert children and adults to hazards of high temperatures.
- High temperatures may ignite clothing or other flammable materials.**
- Keep clothing, furniture, draperies and other combustibles away.

**⚠ WARNING: For Outdoor Use Only.**

**⚠ WARNING**

Do not store or use gasoline or other flammable vapors and liquids in the vicinity of this or any other appliance.

An LP-cylinder not connected for use shall not be stored in the vicinity of this or any other appliance.

**⚠ WARNING! Risk of Fire!**

**Do not install glass doors on this fireplace. Glass doors could cause overheating of adjacent structures.**

**⚠ WARNING:** Improper installation, adjustment, alteration, service or maintenance can cause injury or property damage. Read the installation, operating and maintenance instructions thoroughly before installing or servicing this equipment.

Installation and service of this appliance should be performed by qualified personnel. Hearth & Home Technologies suggests NFI certified or factory-trained professionals, or technicians supervised by an NFI certified professional.



**Read this manual before installing or operating this appliance.  
Please retain this owner's manual for future reference.**

**Congratulations**

Congratulations on selecting an Outdoor Lifestyles gas appliance—an elegant and clean alternative to wood burning appliances. The Outdoor Lifestyles gas appliance you have selected is designed to provide the utmost in safety, reliability, and efficiency.

As the owner of a new appliance, you'll want to read and carefully follow all of the instructions contained in this owner's manual. Pay special attention to all cautions and warnings.

This owner's manual should be retained for future reference. We suggest you keep it with your other important documents and product manuals.

The information contained in this owner's manual, unless noted otherwise, applies to all models and gas control systems.

Your new Outdoor Lifestyles gas appliance will give you years of durable use and trouble-free enjoyment. Welcome to the Outdoor Lifestyles family of appliance products!

|  |   |
|--|---|
| <b>Homeowner Reference Information</b> | <i>We recommend that you record the following pertinent information about your appliance:</i> |
| Model Name: _____                      | Date purchased/installed: _____   |
| Serial Number: _____                   | Location on appliance: _____  |
| Dealership purchased from: _____       | Dealer phone: _____   |
| Notes: _____                           |   |
| _____                                  |   |
| _____                                  |   |

**Listing Label Information/Location**

The model information regarding your specific appliance can be found on the rating plate located on the inside of the control box cover.



7571 215th St. West, Lakeville, MN 55044

IAS U.S. 4.96, Outdoor Fireplace  
CGA-CR-97-003, Outdoor Fireplace

FOR USE AT HIGH ALTITUDES. This installation must conform with local codes or, in the absence of local codes, with the National Fuel Gas Code, ANSI Z223.1/NFPA 54, or the Natural Gas and Propane Installation Code, CSAB149.1.

MODEL: \_\_\_\_\_  
MODELE: \_\_\_\_\_

**Minimum Permissible Gas Supply for Purposes of Input Adjustment:**

|   |                           |
|---|---------------------------|
| Approved Minimum (De Gaz) Acceptable..... | XX.X w.c (Po. Col. d'eau) |
| Maximum Pressure (Pression).....          | XX.X w.c (Po. Col. d'eau) |
| Min/Max Input BTUH: .....                 | XX,XXX/ XX,XXX            |
| Orifice Size:.....                        | #XX / .XXX                |

Open flame Gas appliance - for outdoor installation only.  
Not for use with solid fuel. (*Appareil à gaz à flamme nue - pour installation à l'extérieur seulement. Ne doit pas être utilisé avec un combustible solide.*)

MADE IN USA

**GAS-FIRED**



**29LD**  
OUTDOOR FIREPLACE

**Model Number** →

**Gas Information** →

← **Type of Gas**

# Table of Contents

|   |    |   |    |
|---|----|---|----|
| <b>1 Listing and Code Approvals</b>               |    | <b>7 Finishing</b>                                |    |
| A. Appliance Certification                        | 4  | A. Mantel Projections                             | 17 |
| B. BTU Specifications                             | 4  | B. Facing Material                                | 17 |
| C. High Altitude Installations                    | 4  | <b>8 Appliance Setup</b>                          |    |
| D. Noncombustible Materials Specification         | 4  | A. Clean the Appliance                            | 18 |
| E. Combustible Materials Specification            | 4  | B. Optional Accessories                           | 18 |
| F. Electrical Codes                               | 4  | C. Pilot Shield                                   | 18 |
| G. Fuel   | 4  | D. Install Lava Rock                              | 18 |
| <b>2 Getting Started</b>                          |    | E. Positioning the Logs                           | 18 |
| A. Design and Installation Considerations         | 5  | F. Place Remaining Lava Rock                      | 21 |
| B. Tools and Supplies Needed                      | 5  | G. Install Firescreen                             | 22 |
| C. Inspect Appliance and Components               | 5  | <b>9 Operating Instructions</b>                   |    |
| <b>3 Framing and Clearances</b>                   |    | A. Gas Fireplace Safety                           | 23 |
| A. Select Appliance Location                      | 6  | B. Your Fireplace                                 | 23 |
| B. Stand-Alone Installation                       | 6  | C. Screens  | 23 |
| C. Built-in Installation                          | 6  | D. Before Lighting Fireplace                      | 23 |
| D. Moisture Resistance                            | 6  | E. Lighting the Appliance                         | 24 |
| → E. Clearances and Framing Dimensions            | 7  | F. After the Appliance is Lit                     | 25 |
| <b>4 Appliance Preparation</b>                    |    | <b>10 Troubleshooting</b>                         |    |
| A. Securing and Leveling Appliance                | 10 | A. IntelliFire Plus™ Ignition System              | 26 |
| B. Flashing                                       | 10 | <b>11 Maintaining and Servicing the Appliance</b> |    |
| <b>5 Gas Information</b>                          |    | A. Maintenance and Service Tasks:                 | 29 |
| A. Fuel Conversion                                | 11 | <b>12 Reference Materials</b>                     |    |
| B. Gas Pressure                                   | 11 | A. Appliance Dimension Diagram                    | 30 |
| C. Gas Connection                                 | 11 | B. Service Parts List                             | 32 |
| D. Electrical Codes                               | 12 | C. Warranty                                       | 37 |
| E. Valve Access                                   | 12 | D. Contact Information                            | 39 |
| F. High Altitude Installations                    | 12 |   |    |
| <b>6 Electrical Information</b>                   |    |   |    |
| A. IntelliFire Plus™ Pilot Ignition System Wiring | 13 |   |    |
| → B. Control Module Operation                     | 14 |   |    |
| C. Installing the Optional Electric Kit           | 15 |   |    |

**Note:** An arrow (→) found in the text signifies change in content.

# 1 Listing and Code Approvals

## A. Appliance Certification

**MODELS:** CARODG36I, CARODG36IL,  
CARODG42I, CARODG42IL  
**LABORATORY:** Underwriters Laboratories, Inc. (UL)  
**TYPE:** Outdoor Open-Flame Decorative Gas Appliances  
**STANDARD:** **ANSI Z21.97-2008**

This product is listed to ANSI standards for "Outdoor Open-Flame Decorative Gas Appliances" and "Gas Fired Appliances for Use at High Altitudes".

**Note:** *This installation must conform with local codes. In the absence of local codes you must comply with the **National Fuel Gas Code, ANSI Z223.1-latest edition in the U.S.A. and the CAN/CGA B149 Installation Codes in Canada.***

**Note:** This appliance, when installed, must be electrically grounded in accordance with local codes, or in the absence of local codes with the **National Electrical Code, ANSI/NFPA 70**, if applicable.

## B. BTU Specifications

| Models          | Min/Max Input BTUH | Orifice Size (DMS) |
|-----------------|--------------------|--------------------|
| CARODG36I (NG)  | 36,000/55,000      | #27 / .144         |
| CARODG36IL (LP) | 29,000/50,000      | #46 / .081         |
| CARODG42I       | 33,000/65,000      | #24 / .152         |
| CARODG42IL      | 37,000/62,000      | #43 / .089         |

**Note:** See Section 6.A. for flame adjustment.

## C. High Altitude Installations

**NOTICE:** *If the heating value of the gas has been reduced, these rules do not apply. Check with your local gas utility or authorities having jurisdiction.*

When installing above 2000 feet elevation:

- In the USA: Reduce input rate 4% for each 1000 feet above 2000 feet.
- In CANADA: Reduce input rate 10% for elevations between 2000 feet and 4500 feet. Above 4500 feet, consult local gas utility.

Check with your local gas utility to determine proper orifice size.

## D. Noncombustible Materials Specification

Material which will not ignite and burn. Such materials are those consisting entirely of steel, iron, brick, tile, concrete, slate, glass or plasters, or any combination thereof.

Materials that are reported as passing **ASTM E 136, Standard Test Method for Behavior of Materials in a Vertical Tube Furnace at 750 °C** and **UL763** shall be considered noncombustible materials.

## E. Combustible Materials Specification

Materials made of or surfaced with wood, compressed paper, plant fibers, plastics, or other material that can ignite and burn, whether flame proofed or not, or plastered or unplastered shall be considered combustible materials.

## F. Electrical Codes

If this appliance will be wired, the following applies:

**NOTICE:** *This appliance must be electrically wired and grounded in accordance with local codes or, in the absence of local codes, with **National Electric Code ANSI/NFPA 70-latest edition** or the **Canadian Electric Code CSA C22.1.***

## G. Fuel

This appliance must not be used to burn solid fuel.

## 2 Getting Started

### A. Design and Installation Considerations

Improper installation, adjustment, alteration, service or maintenance can cause injury or property damage. For assistance or additional information, consult a qualified service technician, service agency or your dealer.

The Carolina Series outdoor gas fireplace is designed for outdoor use and may be installed as a standalone unit or built into an outside wall.

It may be installed in screened porches and lanais that meet these minimum requirements:

- Minimum porch area - 96 square feet
- Minimum ceiling height - 82 in.
- Minimum distance from top of appliance opening to ceiling - 49.5 in.

A minimum of one wall can be screened but must be open to outside ventilation. Minimum requirements are:

- Minimum screen area - 64 square feet
- Minimum screen top height - 80 in.

If this fireplace is to be installed within a wall, you must:

- Provide access to the gas controls.
- Slope outdoor floor (and hearth) away from fireplace.
- Flash the perimeter of the fireplace, corners and the fireplace face in a manner consistent with regional practices as required to prevent water penetration around the fireplace or manage water that may penetrate the fireplace. See Section 3.D. and Figure 3.1 for more information regarding wall and enclosure construction.

The fireplace may be installed on a wood or noncombustible deck.

Refer to Sections 3.D. and 3.E. for clearances.

When planning an appliance installation, it is necessary to determine the following information before installing:

- Where the appliance is to be installed:
  - Clearance to side walls
  - Location of adjacent stairwells
  - Doors
  - Windows
  - Walkways
  - Wires
  - Possibility of flooding or running water
- Location of gas supply piping
- Electrical wiring requirements
- Framing and finishing details

### B. Tools and Supplies Needed

Before beginning the installation be sure that the following tools and building supplies are available.

- |  |                                   |
|--|-----------------------------------|
| Reciprocating saw  | Framing material                  |
| Pliers   | Non-corrosive leak check solution |
| Hammer   | Gloves                            |
| Phillips screwdriver   | Framing square                    |
| Level  | Electric drill and bits (1/4 in.) |
| 3/4 in. wrench   | 7/16 in. wrench                   |
| 7/8 in. wrench   | 1/4 in. nut driver                |
| Crescent wrench  | Pipe sealant                      |
| Plumb line   | Safety glasses                    |
| Manometer  | Voltmeter                         |
| Tape measure   |                                   |
| Flat blade screwdriver                                       |                                   |
| Caulking material (300°F minimum continuous exposure rating) |                                   |
| 1/2 - 3/4 inch length, #6 or #8 Self-drilling screws         |                                   |

### C. Inspect Appliance and Components

**WARNING! Risk of Fire or Explosion! Damaged parts could impair safe operation. DO NOT install damaged, incomplete or substitute components. Keep appliance dry.**

- Carefully remove the appliance and components from the packaging.
- Remove screen package from grate, set aside.
- The gas logs are packaged separately and located on top of the firebox along with the lava rock. The installation manual will be found inside the firebox.
- Report any parts damaged in shipment to your dealer.
- **Read all of the instructions before starting the installation. Follow these instructions carefully during the installation to ensure maximum safety and benefit.**

**WARNING! Risk of Fire, Explosion or Electric Shock! DO NOT use this appliance if any part has been under water. Call a qualified service technician to inspect the appliance and to replace any part of the control system and/or gas control which has been under water.**

Hearth & Home Technologies disclaims any responsibility for, and the warranty will be voided by, the following actions:

- Installation and use of any damaged appliance or vent system component.
- Modification of the appliance or vent system.
- Installation other than as instructed by Hearth & Home Technologies.
- Improper positioning of the gas logs or the glass door.
- Installation and/or use of any component part not approved by Hearth & Home Technologies.

**Any such action may cause a fire hazard.**



# 3 Framing and Clearances

**NOTICE:** Illustrations reflect typical installations and are for DESIGN PURPOSES ONLY. Illustrations/diagrams are not drawn to scale. Actual installation may vary due to individual design preference.

## A. Select Appliance Location

Refer to Figures 3.1, 3.2 and 3.3.

When selecting a location for your appliance it is important to consider where the appliance is to be installed:

- Clearance to side walls
- Location of adjacent stairwells
- Doors
- Windows
- Walkways
- Wires
- Possibility of flooding or running water

**WARNING! Risk of Fire or Burns! The appliance is hot and wind may cause flames to reach out in front.**

- Keep furniture, draperies and other combustibles away.
- Locate the appliance away from traffic areas.
- Do not block air openings.
- DO NOT place rugs, carpeting or other combustible materials on the floor directly in front of the appliance.
- Clean up fallen leaves, branches and other combustible materials before using the appliance.
- See Figure 3.1 for required clearances.

**CAUTION! The appliance is hot and wind may cause flames to reach out in front. Install on wood or solid noncombustible surfaces extending full width and depth to prevent damage.**

- **DO NOT** install directly on carpeting, vinyl, plastic composite decking or combustible surfaces other than wood.
- When installed on wood, a 16" noncombustible hearth extension in front of the appliance is recommended. See Figure 3.3.

## B. Stand-Alone Installation

This fireplace may be installed as a stand-alone unit.

- Tape and seal all joints and corners.
- Provide proper flashing and moisture management if installed on surfaces that may rot or otherwise be damaged by water. (See also sections 3.C. and 3.D.)

When the stand-alone surround is constructed completely of noncombustible materials, stand-offs may be removed to permit a smaller structure.

- Air space clearances are not required for stand-alone construction with noncombustible materials.

## C. Built-in Installation

When this fireplace is installed into a wall, we recommend that the wall be an exterior wall system.

- See framing measurements in Figure 3.1.
- You must maintain 1 1/2 in. (38 mm) airspace at the sides and back of the fireplace.
- Header must be placed a minimum of 6 in. (152 mm) above the top of the fireplace.
- Noncombustible wall sheathing material is required the first 36 in. above the top of the firebox opening.
  - Remove the existing top front (cement board) and replace with 36 x 45 1/2 in. (minimum) cement board. Allow overlap on the framing studs. See Figure 3.1.
- The control box **MUST** be relocated to be easily accessible. See Section 5.D.
- Flash the perimeter of the fireplace, corners and the fireplace face in a manner consistent with regional practices as required to prevent water penetration around the fireplace or manage water that may penetrate the fireplace. See Section 3.D. and Figure 3.1 (CARODG36) and 3.2 (CARODG42) for more information regarding wall and enclosure construction.

**NOTICE:** Soot may accumulate on the area above the firebox opening and may require periodic cleaning.

**WARNING! Risk of Fire! Maintain specified air space clearances to appliance:**

- Insulation and other materials must be secured to prevent accidental contact.
- The chase/enclosure must be properly blocked to prevent blown insulation or other combustibles from entering and making contact with fireplace or chimney.
- Failure to maintain airspace may cause overheating and a fire.

## D. Moisture Resistance

This outdoor fireplace will shed moderate amounts of water, but is not waterproof. This appliance must be enclosed or covered with noncombustible finish material and all joints sealed to prevent water infiltration.

The fireplace fire box will not perform as an exterior wall. Moisture penetration must be considered for construction that places the fireplace in structure walls or on moisture sensitive surfaces.

**When installed on exterior walls:** Hearth & Home Technologies recommends that the fireplace chase be constructed outside the structure's weather envelope. Where the platform meets the wall, use a flashing detail similar to that required for attached decks. Chase platforms, including hearths should slope away from the structure at 1/8 in. to 1/4 in. per foot. The fireplace can be shimmed level.

## E. Clearances and Framing Dimensions CARODG36I, CARODG36IL

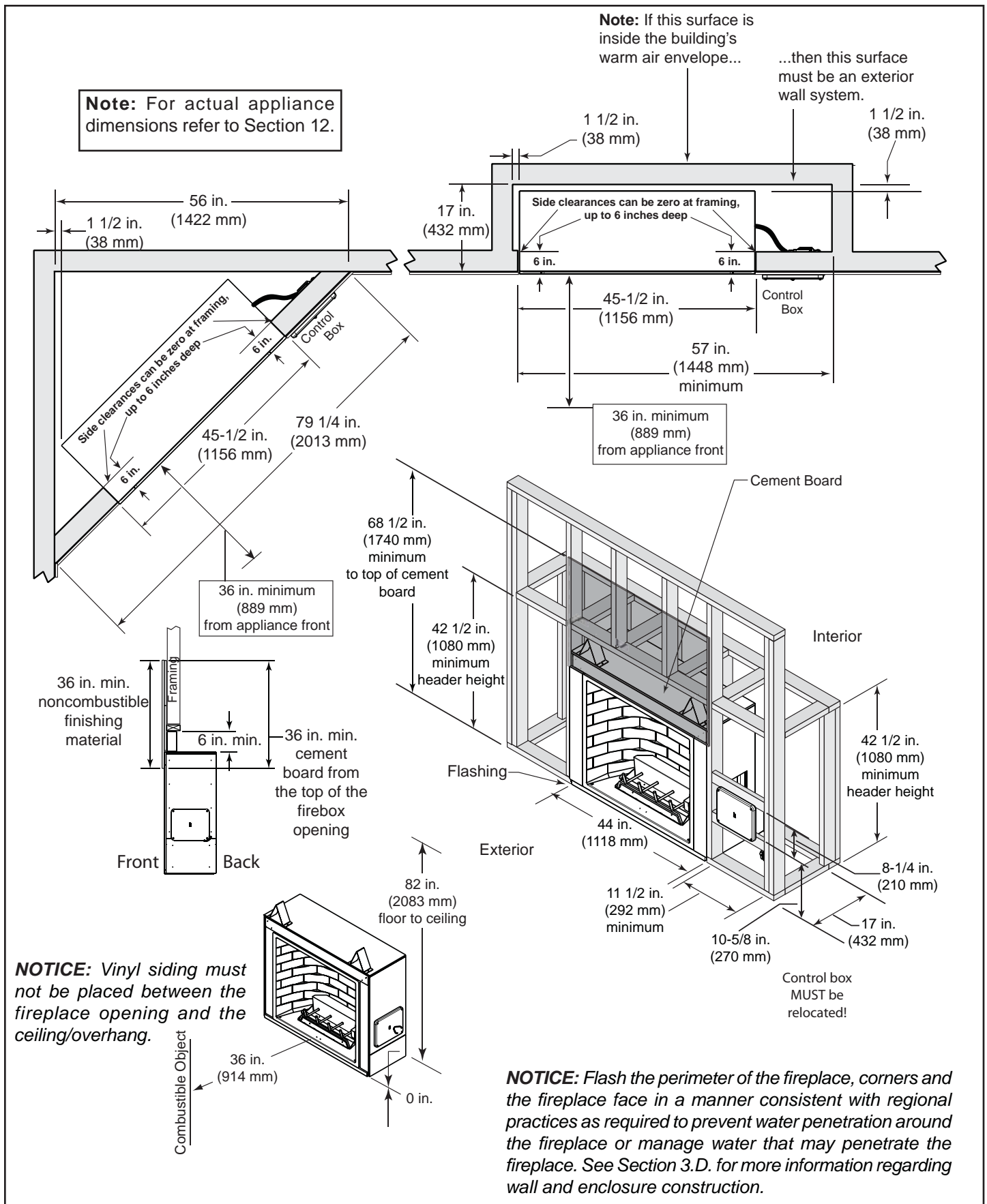

➔ Figure 3.1 Appliance Locations and Framing Dimensions - CARODG36I, CARODG36IL

## E. Clearances and Framing Dimensions CARODG42I, CARODG42IL

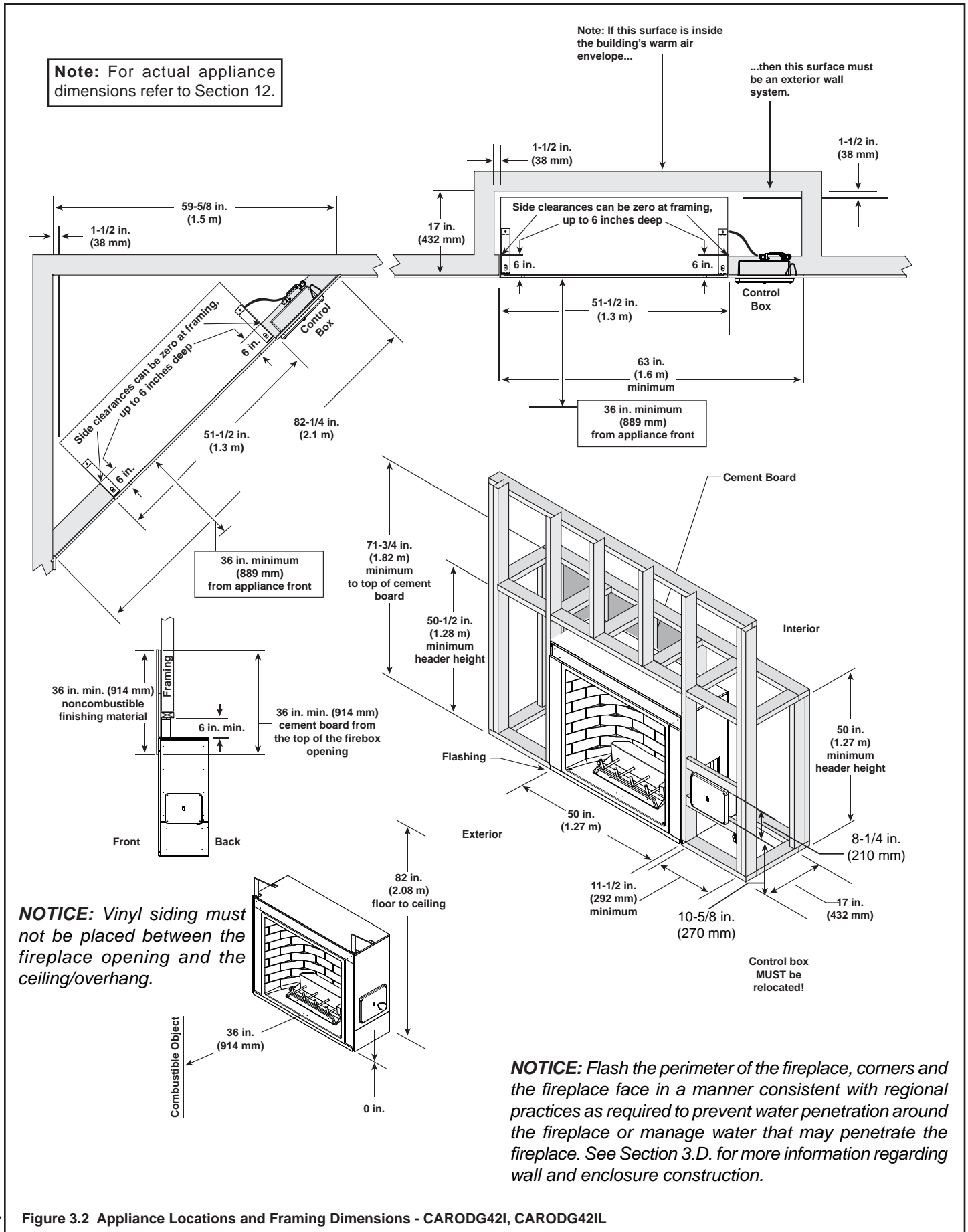

→ Figure 3.2 Appliance Locations and Framing Dimensions - CARODG42I, CARODG42IL



**WARNING! Risk of Fire!**  
 Comply with all minimum clearances to combustibles as specified. Framing or finishing material closer than the minimums listed must be constructed entirely of non-combustible materials (i.e., steel studs, concrete board, etc).

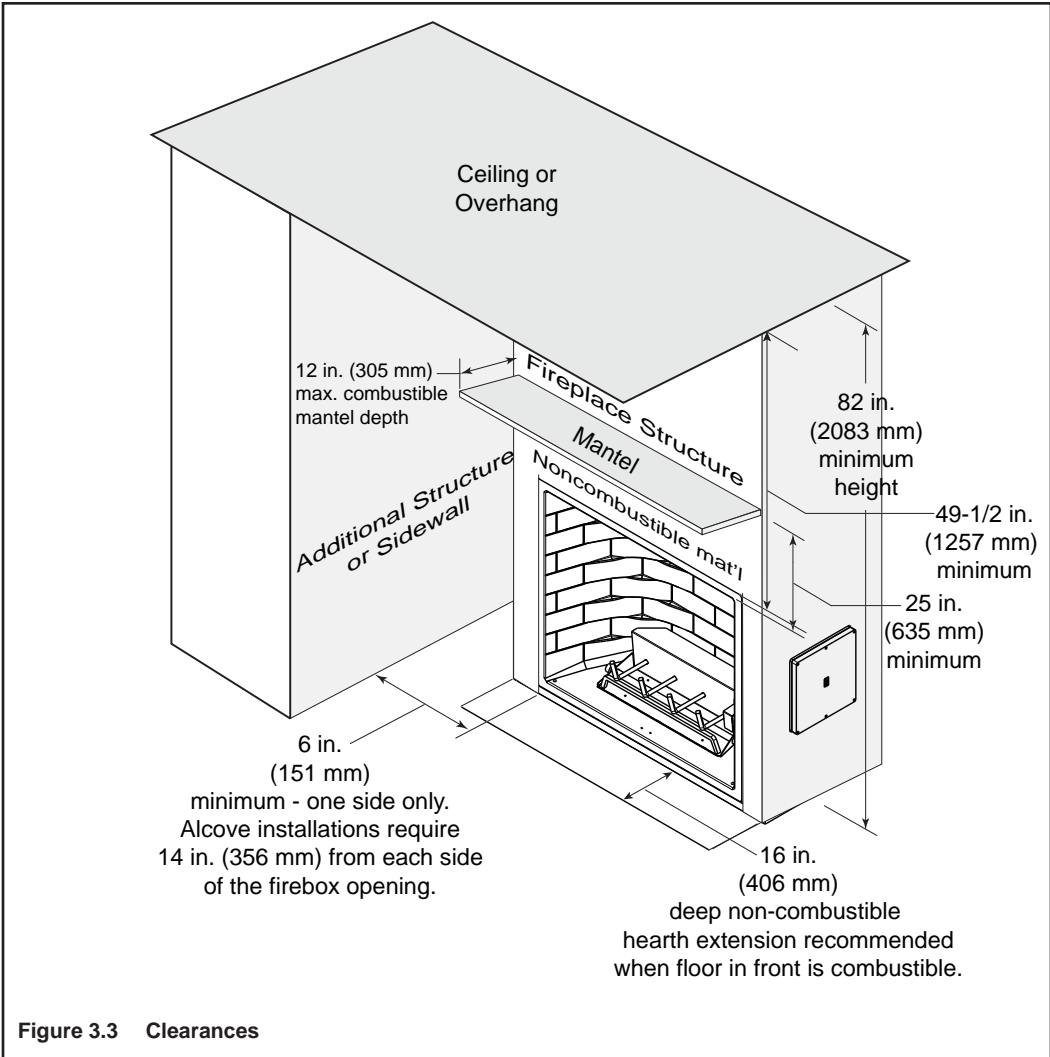

Figure 3.3 Clearances

# 4 Appliance Preparation

**CAUTION! Risk of Cuts, Abrasions or Flying Debris.**  
Wear protective gloves and safety glasses during installation. Sheet metal edges are sharp.

## A. Securing and Leveling Appliance

Position, level, and secure the appliance.

- Place the appliance into position on either a wood or noncombustible continuous flat surface.
- Level the appliance from side to side and front to back.
- Shim the appliance with noncombustible material, such as sheet metal, as necessary.
- Nailing tabs must be moved from shipping position to installation position and secured to framing. Remove screws and reposition nailing tabs as shown in Figure 4.1.

## B. Flashing

- Flash the fireplace in a manner consistent with regional practices to prevent water penetration around the fireplace. Due to elevated temperatures across the top of the fireplace, metal flashing and high temperature sealant must be used. Adhesive polymeric flashing materials may melt.
- For brick, stone, stucco and similar construction, weep screeds should be installed per regional codes.
- See Section 3.D. and Figure 3.1 for more information regarding wall and enclosure construction required to prevent moisture penetration into the structure. The fireplace will shed moderate amounts of water but is not waterproof.

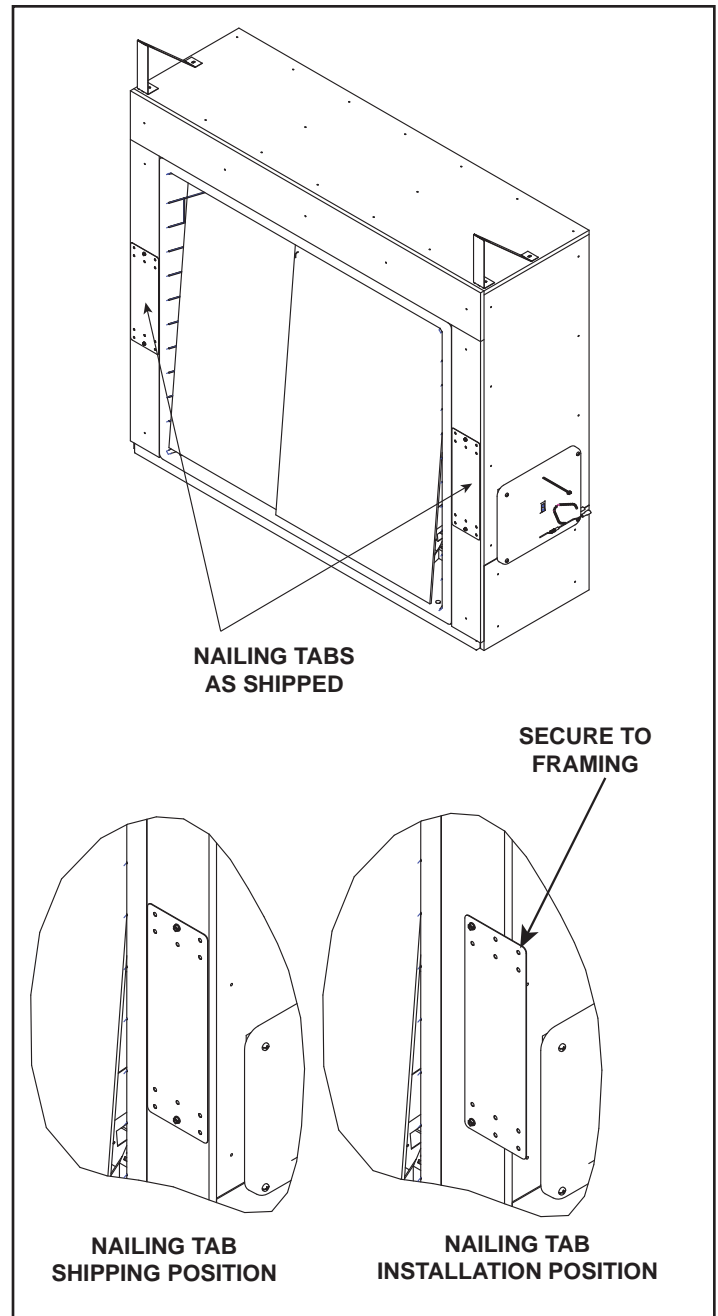

Figure 4.1 Positioning and Securing Nailing Tab

# 5 Gas Information

## A. Fuel Conversion

Before making gas connections ensure appliance being installed is compatible with the available gas type.

Any natural or propane gas conversions necessary to meet the appliance and locality needs must be made by a qualified technician using Hearth & Home Technologies specified and approved parts.

## B. Gas Pressure

Proper input pressures are required for optimum appliance performance. Gas line sizing requirements need to be made following **NFPA51**.

**⚠ WARNING**

**Fire Risk**  
**Explosion Risk**

*High pressure will damage valve.*

- Disconnect gas supply piping **BEFORE** pressure testing gas line at test pressures above 1/2 psig.
- Close the manual shutoff valve **BEFORE** pressure testing gas line at test pressures equal to or less than 1/2 psig.

*Low pressure may cause explosion.*

Pressure requirements for appliance are shown in the table below.

| Pressure               | Natural Gas      | Propane          |
|------------------------|------------------|------------------|
| Minimum Inlet Pressure | 5.0 inches w.c.  | 11.0 inches w.c. |
| Maximum Inlet Pressure | 10.0 inches w.c. | 13.0 inches w.c. |
| Manifold Pressure      | 3.5 inches w.c.  | 10.0 inches w.c. |

These pressures can be verified through the access panel as shown in Section E. Valve Access.

## C. Gas Connection

**Note:** Have the gas supply line installed in accordance with local building codes, if any. If not, follow **ANSI 223.1**. Installation should be done by a qualified installer approved and/or licensed as required by the locality. (In the Commonwealth of Massachusetts installation must be performed by a licensed plumber or gas fitter.)

If control box is to be relocated, move it at this time to avoid making the gas connection more than once.

**Note:** A listed (and Commonwealth of Massachusetts approved) 1/2 in. (13 mm) T-handle manual shutoff valve and flexible gas connector are connected to the 1/2 in. (13 mm) control valve inlet.

- If substituting for these components, please consult local codes for compliance.**

**Note:** Gas line **MUST** be run from right side of appliance.

The access panel is located below the control box. It will be easier to make gas connection after the control box is in its final position. If necessary, relocate control box prior to making gas connection. See Section 5.E.

- Remove the screws holding the access panel.
- Set the panel and screws aside for reinstallation.

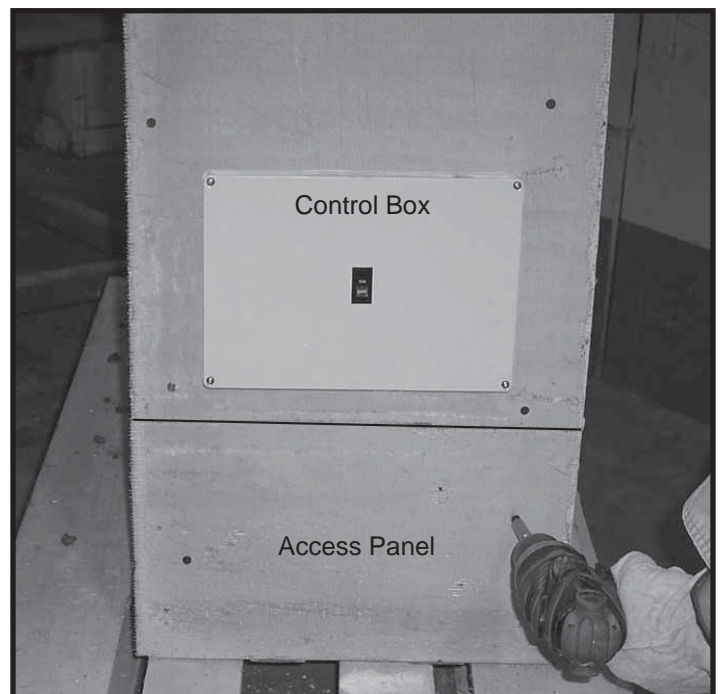

Figure 5.1 Control Box & Access Panel Locations

- The incoming gas line can be installed from the bottom of the fireplace structure, from the side or from the rear (drilling through the cement board may be necessary).
- The incoming line should be connected to the 1/2 in. connection on the manual shutoff valve provided with the fireplace.

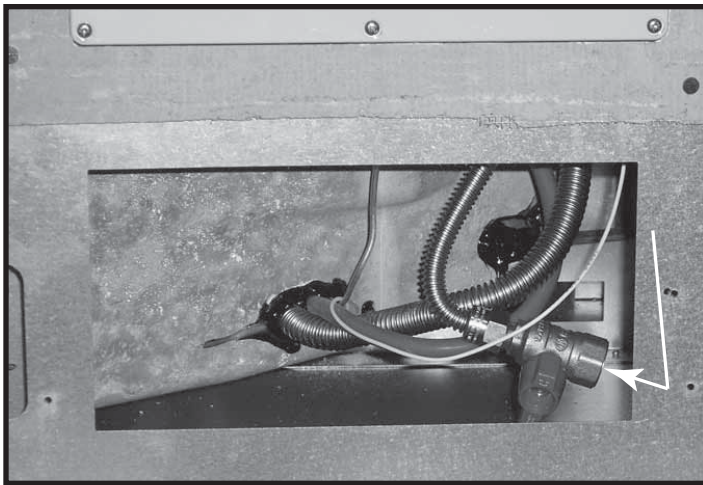

Figure 5.2 Connect Incoming Gas Line to Manual Shutoff Valve

- Accessibility to the shutoff valve is required after installation, or another accessible shutoff is required.
- The flex line and gas shutoff valve can be accessed after installation by removing four screws from the valve mounting bracket at the rear of the control box.

**WARNING! Risk of Fire, Explosion or Asphyxiation!** Check all fittings and connections with a non-corrosive commercially available leak-check solution. **DO NOT** use open flame. Fittings and connections could have loosened during shipping and handling.

**WARNING! Risk of Fire or Explosion!** Gas build-up during line purge could ignite.

- Purge should be performed by qualified service technician.
- Ensure adequate ventilation.
- Ensure there are no ignition sources such as sparks or open flames.

## D. Electrical Codes

If the optional electrical kit is going to be used, the wiring should be done at this time. See Section 6.A.

**NOTICE:** This appliance must be electrically wired and grounded in accordance with local codes or, in the absence of local codes, with **National Electric Code ANSI/NFPA 70-latest edition** or the **Canadian Electric Code CSA C22.1**.

- A 110/120 VAC circuit for this product must be protected with ground-fault circuit-interrupter protection, in compliance with the applicable electrical codes.
- National electrical codes require a minimum of three feet of space in front of the access panel for service accessibility.

## E. Valve Access

The valve and controls are located in the control box (Refer to Figure 5.1). Remove the screws and remove the lid.

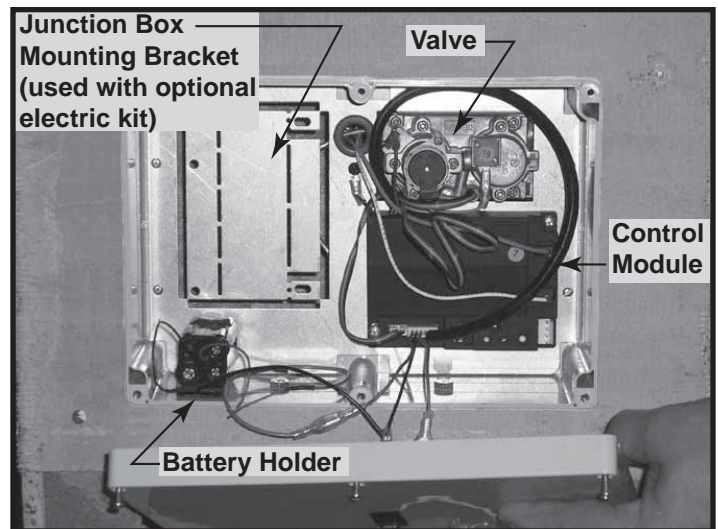

Figure 5.3 Control Box

The control box is designed to be moved out to allow for the thickness of the finish material or moved from the unit and repositioned.

- Loosen the two bolts found inside the box in the bottom of the control box.
- Slide the box out as necessary.
- Tighten the screws.
- The control box can be removed from the appliance and repositioned (up to approximately 6 ft. from the appliance).
- Make sure the lid will fit over the box without interfering with the finish material.
- The control box lid must be accessible and removable.
- Caulk around the perimeter of the box to prevent water infiltration.

**Note:** The control box lid can be painted as desired. Use sandpaper or other abrasive material to scuff the surface prior to painting.

## F. High Altitude Installations

**NOTICE:** If the heating value of the gas has been reduced, these rules do not apply. Check with your local gas utility or authorities having jurisdiction.

When installing above 2000 feet elevation:

- In the USA: Reduce input rate 4% for each 1000 feet above 2000 feet.
- In CANADA: Reduce input rate 10% for elevations between 2000 feet and 4500 feet. Above 4500 feet, consult local gas utility.

Check with your local gas utility to determine proper orifice size.

# 6 Electrical Information

## A. IntelliFire Plus™ Pilot Ignition System Wiring

- This appliance is equipped with an intermittent pilot ignition (IPI) control which operates on a 6-volt system.
- This appliance is supplied with a battery pack which is located in the control box. A wiring diagram is shown in Figure 6.1.
- The battery pack requires four batteries (not included).
- An optional electric kit is available. This allows the system to be operated with 110/120 VAC instead of batteries. See Section 6.B.
- The appliance comes standard with an OFF/ON switch on the control box lid
- Optional RC100 wireless wall switch (OFF/ON)
- Optional RC200 wireless remote allows flame adjustment (AUX200 is not required since there is no fan used).

- The module should be in the REMOTE position when using the switch preinstalled in the control box lid when using the RC100 wireless wall switch. Putting the switch in the OFF position will disable all fireplace controls. See ON/OFF/REMOTE inset, Figure 6.1.

**WARNING! Risk of Shock!** Replace damaged wire with type 105° C rated wire. Wire must have high temperature insulation.

**WARNING! Risk of Shock!** Label all wires prior to disconnection when servicing controls. Wiring errors can cause improper and dangerous operation. Verify proper operation after servicing.

Hearth & Home Technologies recommends that IntelliFire Plus™ wireless controls be used for their features and functionality with the IntelliFire Plus™ ignition system.

**NOTICE:** RC100 & RC200 must be protected from the elements.

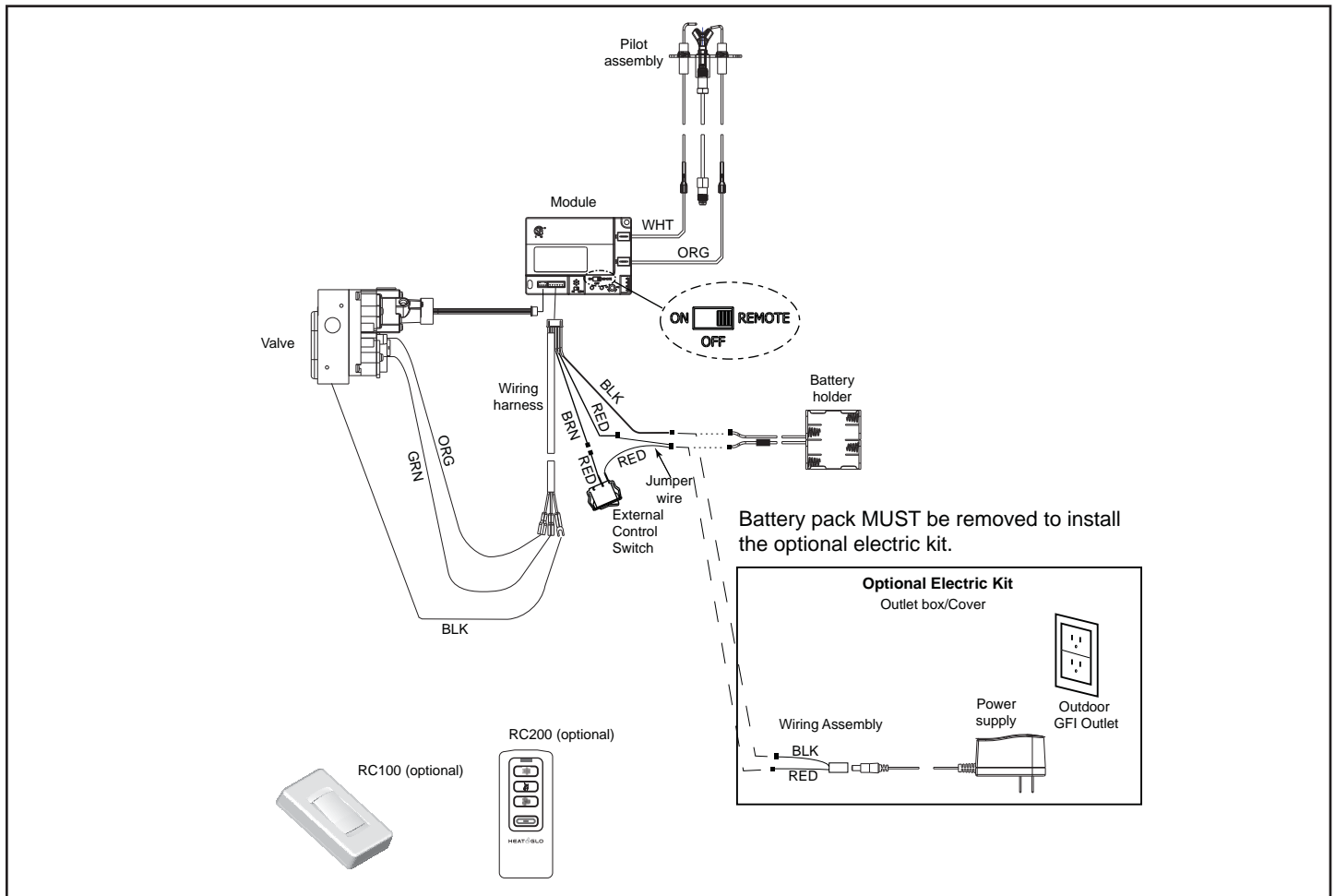

Figure 6.1 Intermittent Pilot Ignition (IPI) Wiring Diagram



## B. Control Module Operation

1. The control module has an ON/OFF/REMOTE selector switch that must be set. See Figure 6.1 and 6.2.  
OFF Position: Appliance will ignore all power inputs and will not respond to any commands from a wall switch or remote. The unit should be in the OFF position during installation, service, battery installation, fuel conversion, and in the event that the control goes into LOCK-OUT mode as a result of an error code. The external control switch must be in the OFF position also.  
ON Position: Appliance will ignite and run continuously in the HI flame setting, with no adjustment in flame output. This mode of operation is primarily used for initial installation or power outage operation with battery backup. The external control switch must be in the ON position also.  
REMOTE Position: Appliance will initiate commands from an optional wired wall switch and/or one of the optional wireless remote options. The external control switch must be in the ON position also.
2. With the module in REMOTE mode, the flame output can be adjusted with the HI/LO selector switch on the module. See Figure 6.2. Note that the control module will always ignite the fireplace on HI and remain so for the initial 10 seconds of operation. If the HI/LO is switched to the LO position, the flame output will automatically drop to the lowest setting after the flame has been established for 10 seconds. After this 10-second period, the flame can be adjusted from HI to LO with the switch.
3. The control module has a safety feature that automatically shuts down the fireplace after nine hours of continuous operation without receiving a command from the wall switch or optional remote.
4. The module has the capability to recognize potential malfunctions. If these occur, it will fail to ignite and/or respond to a command to ignite. If it fails to ignite, turn off the external control switch and wait five seconds and turn back on. If it fails to light the second time, see Trouble Shooting guide. In this case, the module may have gone into LOCK-OUT mode. In this state, it will emit a RED/GREEN LED error code. To reset the error code, switch the selector to OFF, and then back to REMOTE or ON. If the ignition command again fails, the module will emit an LED error code prior to going back into LOCK-OUT mode. Contact your dealer for service if this occurs.

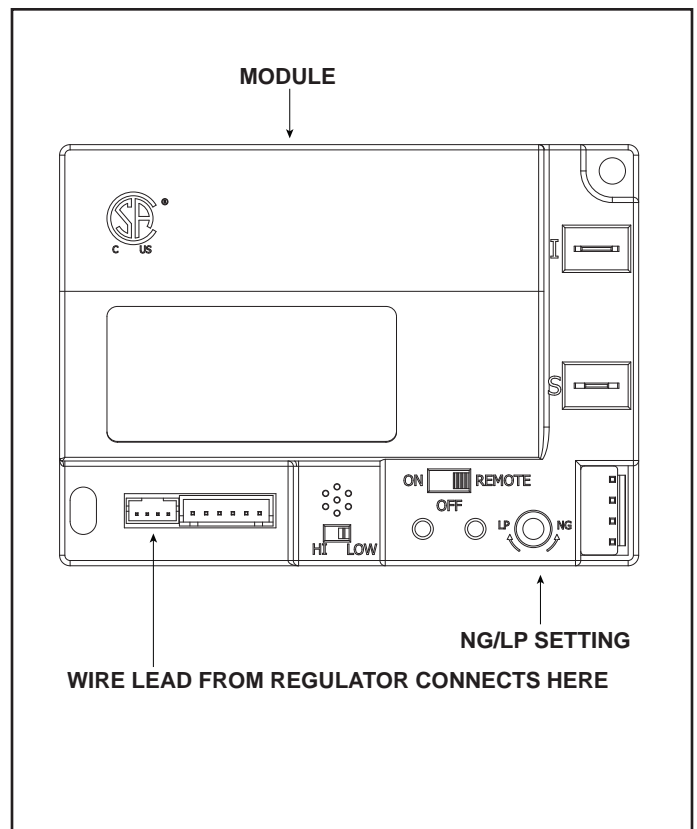

Figure 6.2 Control Module

### Nine Hour Safety Shutdown Feature

The appliance has a safety feature that automatically shuts down the fireplace after nine hours of continuous operation without receiving a command from the wall switch or optional remote.

## C. Installing the Optional Electric Kit

- Remove four screws to remove cover from the control box.



Figure 6.3 Remove Control Cover

- Remove the junction box bracket by prying loose with a screwdriver. Remove the two screws shown in Figure 6.4. Cut out and remove insulation from behind junction box bracket as shown in Figure 6.5.

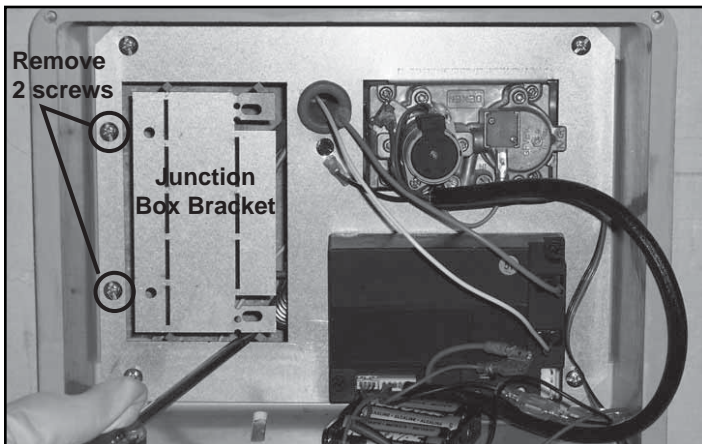

Figure 6.4 Remove Junction Box Bracket & Two Screws

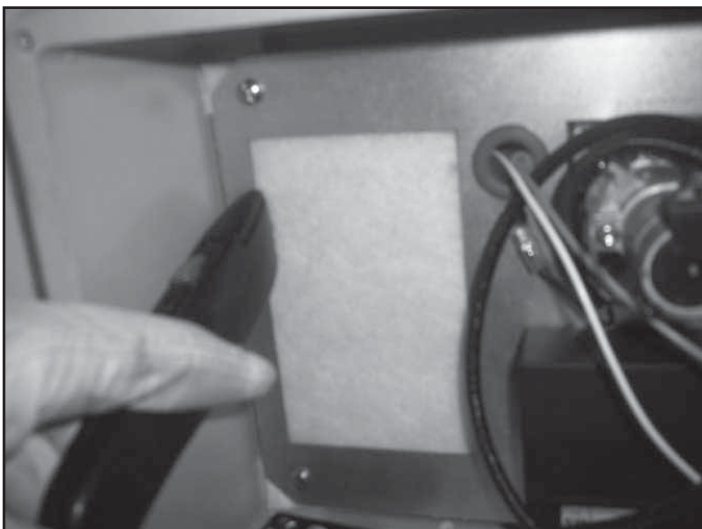

Figure 6.5 Cut and Remove Insulation

- Make hand bends to bracket as shown in Figure 6.6:

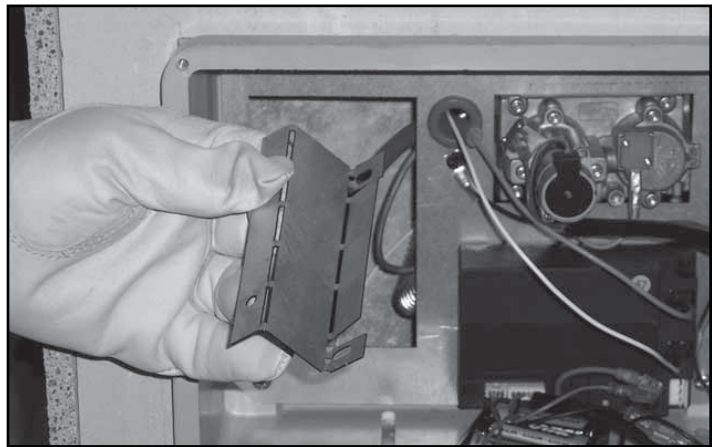

Figure 6.6 Hand-bend Bracket

- Fasten bracket to junction box with two screws (provided with junction box).

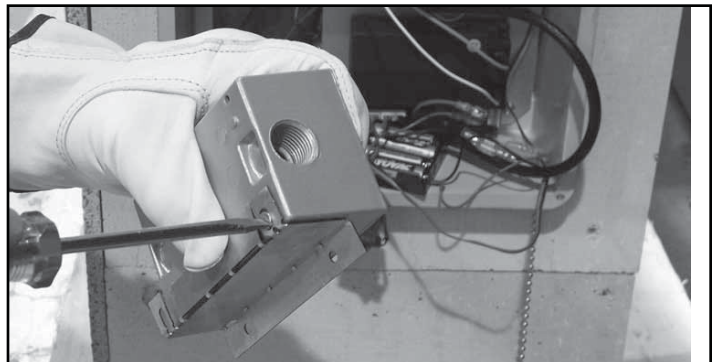

Figure 6.7 Fasten Bracket to Junction Box

- Thread wire into junction box.
- Place junction box into the control box, matching holes as shown, and fasten with the two screws removed in Figure 6.4.

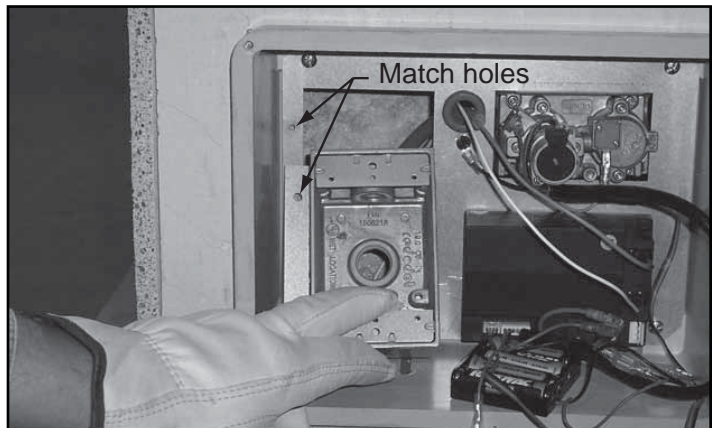
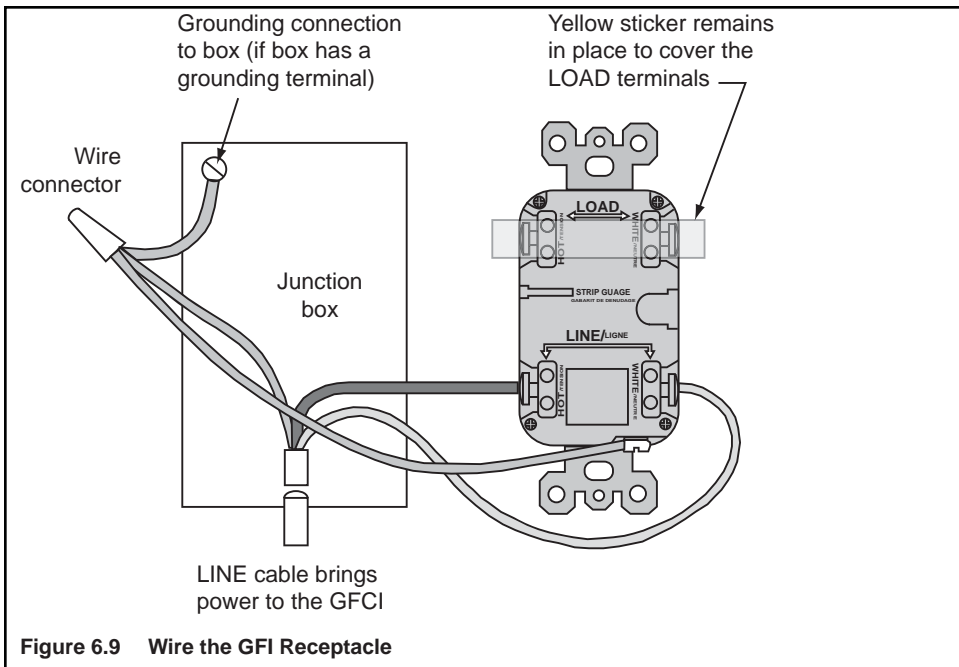
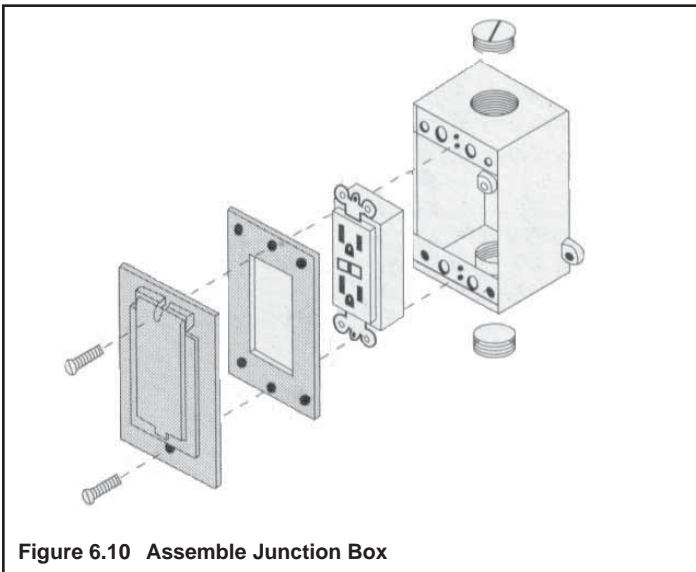

Figure 6.8 Place & Fasten Junction Box

- Wire the GFI receptacle as shown below:



- Assemble the junction box.



- Disconnect the battery holder wires from the red and black wires of the wiring harness from the switch and module. Connect the red and black wires of the wiring assembly included with the electric kit to the red and black wires to the switch and module. Plug the power supply wire into the wire assembly and then into the outlet. Refer to Figure 6.1.
- Replace the cover on the control box.

# 7 Finishing

## A. Mantel Projections

Figure 7.1 shows the dimensions for mantels or other combustible projections above the fireplace opening.

**WARNING! Risk of Fire!** Comply with all minimum clearances to combustibles as specified. Framing or finishing material closer than the minimums listed must be constructed entirely of noncombustible materials (i.e., steel studs, concrete board, etc.).

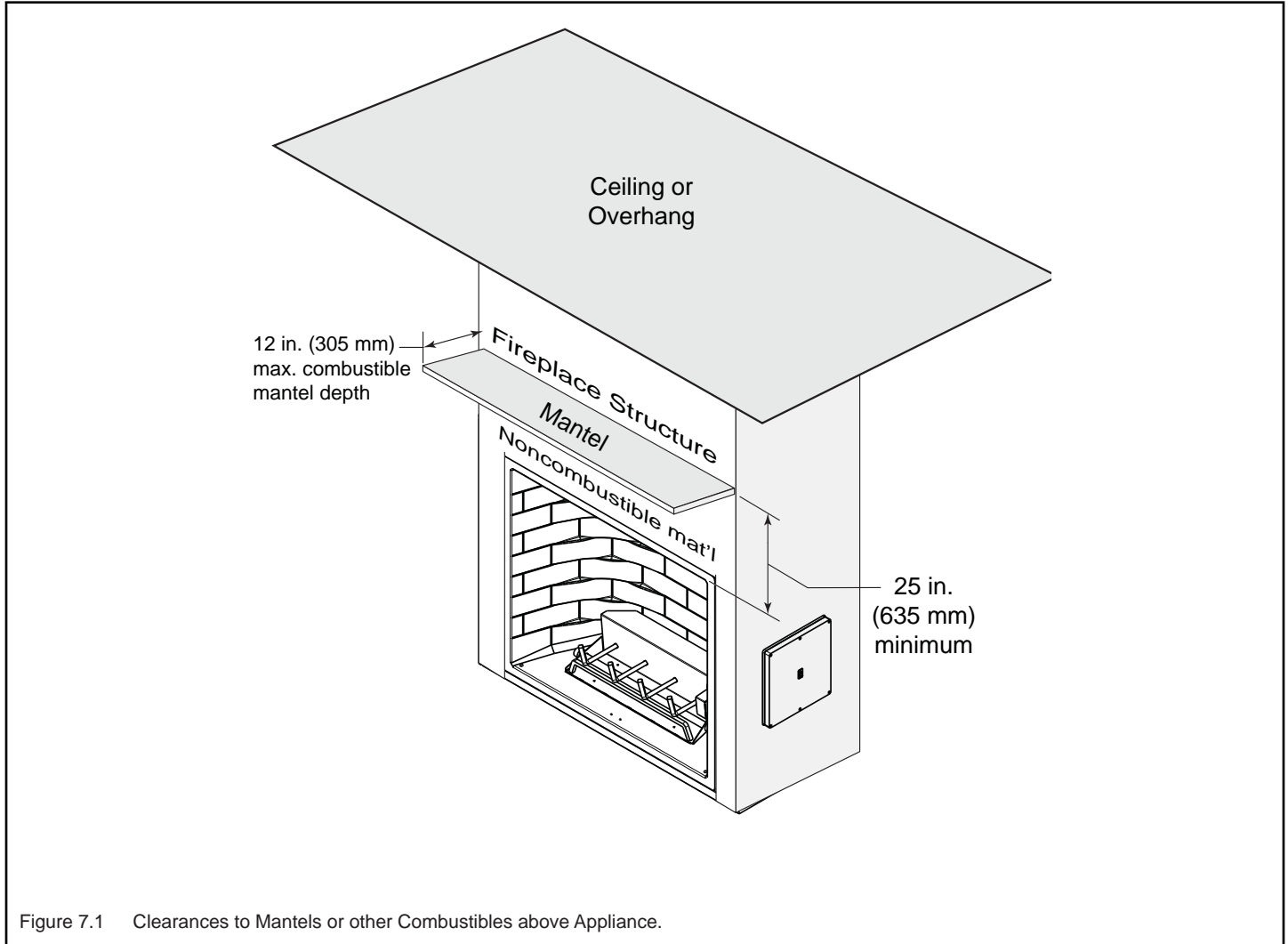

Figure 7.1 Clearances to Mantels or other Combustibles above Appliance.

## B. Facing Material

The appliance can be covered with any noncombustible material. Refer to Section 1.D.

It is possible for the face of the unit above the fireplace opening to show signs of soot. Clean that area as frequently as necessary to eliminate a build up of soot or permanent discoloration. A noncombustible ledge (shelf) approximately 3 inches above the opening and a minimum of 3 inches out from the face of the unit incorporated into the facing material will help prevent the soot from going up the wall.

**Note:** The control box lid can be painted as desired.  
Use sandpaper or other abrasive material to scuff the surface prior to painting.



# 8 Appliance Setup

## A. Clean the Appliance

Clean/vacuum any material that may have accumulated inside the firebox.

## B. Optional Accessories

Install approved accessories per instructions included with accessories. Contact your dealer for a list of approved accessories.

**WARNING! Risk of Fire and Electric Shock! Use ONLY Hearth & Home Technologies-approved optional accessories with this appliance. Using non-listed accessories could result in a safety hazard and will void the warranty.**

## C. Pilot Shield

Ensure the pilot shield is still in the position shown in the photo below. Shipping could cause it to become displaced.

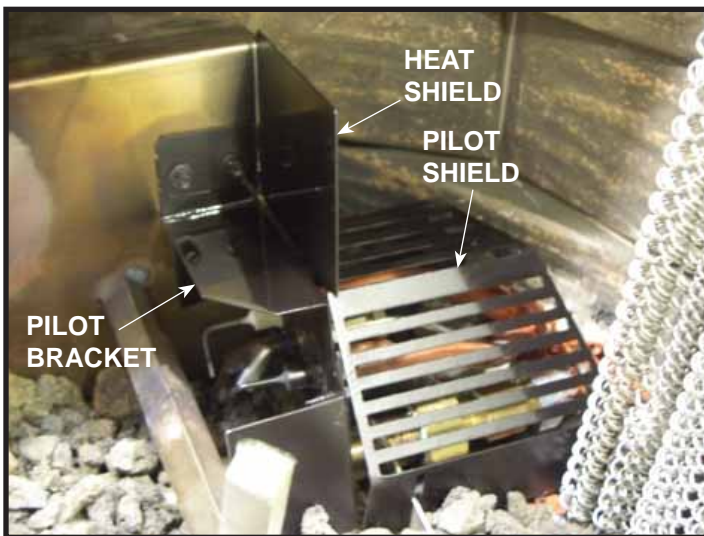

Figure 8.1 Pilot Shield Position

## D. Install Lava Rock

Pour lava rock into the burner pan and cover the burner tube. DO NOT cover the burner tube from the right grate support to the pilot assembly. See Figure 8.2 & 8.3. There is extra rock provided to cover the front of the firebox if desired.

**NOTICE!** Do not cover area around pilot assembly with lava rock. Too much rock will interfere with pilot flame ignition, rectification, and wind stability.



Figure 8.2 Install Lava Rock



Figure 8.3 Install Lava Rock

## E. Positioning the Logs

### CAROLINA-36

- Place the rear log on the shelf against the appliance rear wall. Position log as far back on the shelf as possible.

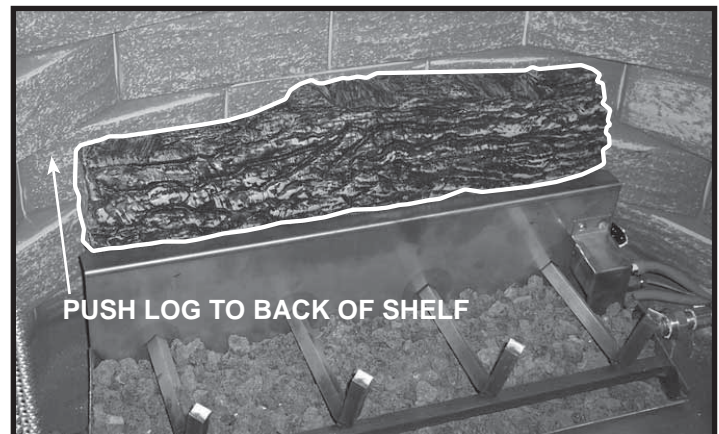

Figure 8.4 Place Rear Log - Carolina-36



- Place the left front log on the grate against the front of the grate. Fit notch in log to grate bar as shown below.

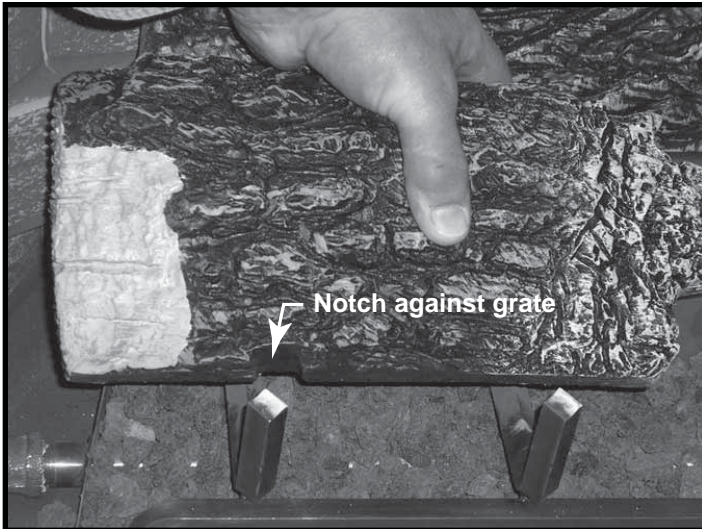

Figure 8.5 Place Left Front Log - 36

- Place right front log on the grate against the front of the grate. Fit notches into the bottom of the log to position it as shown in Figure 8.6

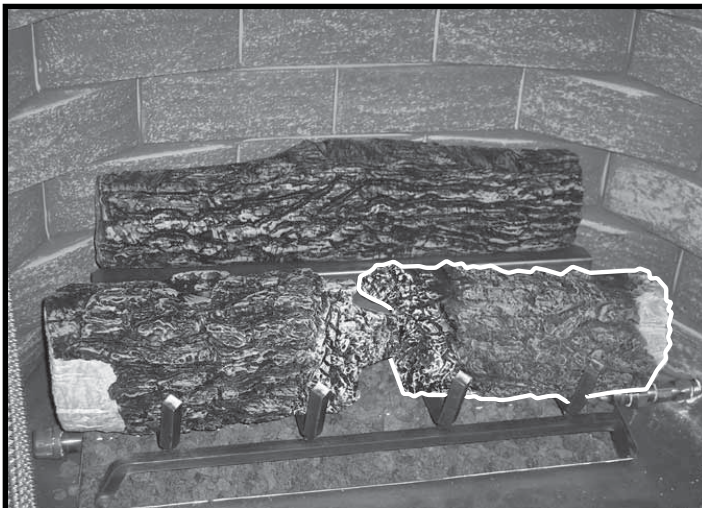

Figure 8.6 Place Right Front Log

- Place the top right log. There are flat indentations on the rear and right front logs to locate the top right log.

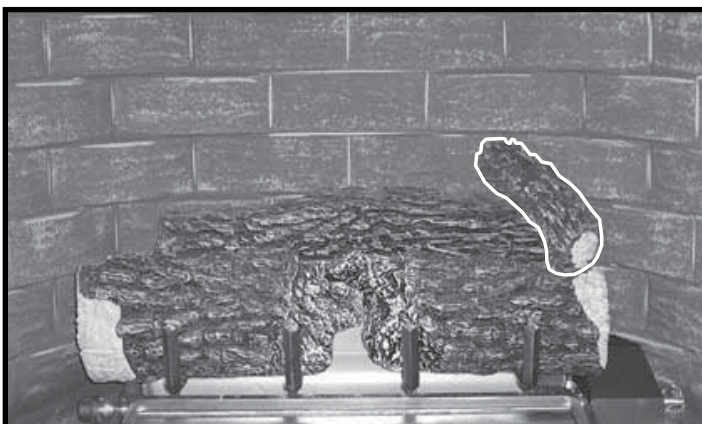

Figure 8.7 Place Top Right Log - 36

- Place the top left log into the indentations on the rear and left front logs.

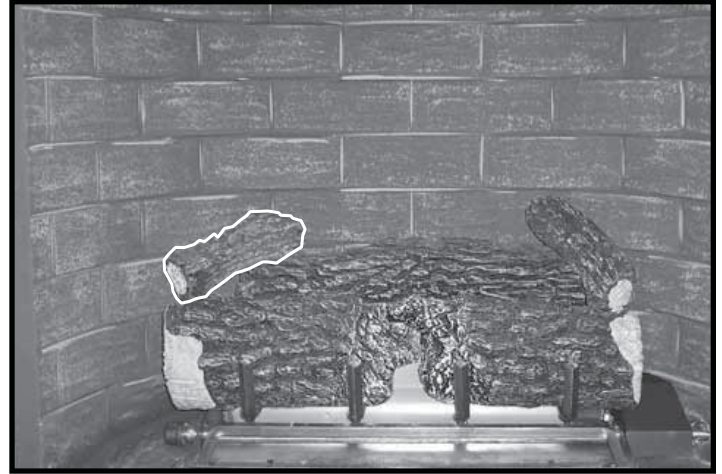

Figure 8.8 Place Top Left Log - 36

- Place the fork of the center Y log above the middle front grate bar and rest its back on the indentation in the middle of the rear log.

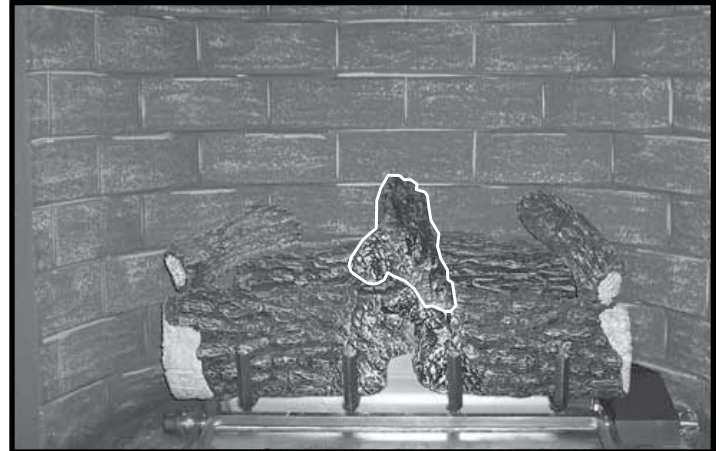

Figure 8.9 Place Center Y Log - 36

- Place the top center log as shown below.

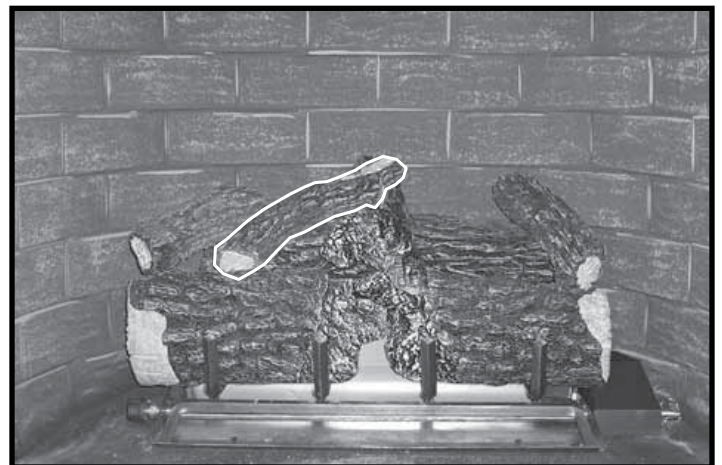

Figure 8.10 Place Top Center Log -36

- Place the left and right center logs as shown in Figure 8.10



- The use of the top rear log is optional. It could cause sooting in high-wind areas.

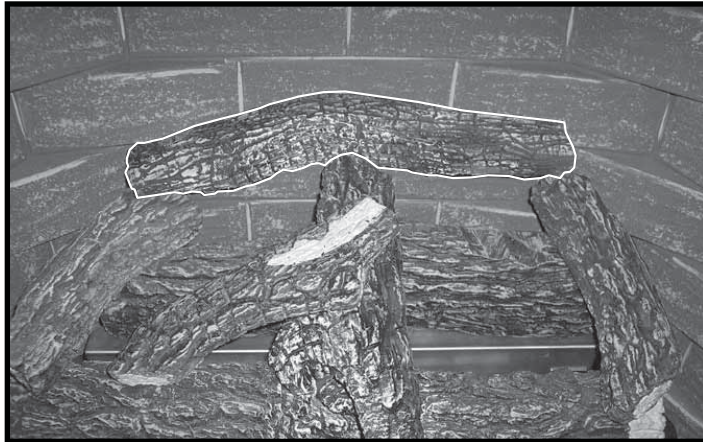

Figure 8.15 Place Top Rear Log (optional)

## CAROLINA-42

- Place the rear log on the shelf against the appliance rear wall. Position log as far back on the shelf as possible.

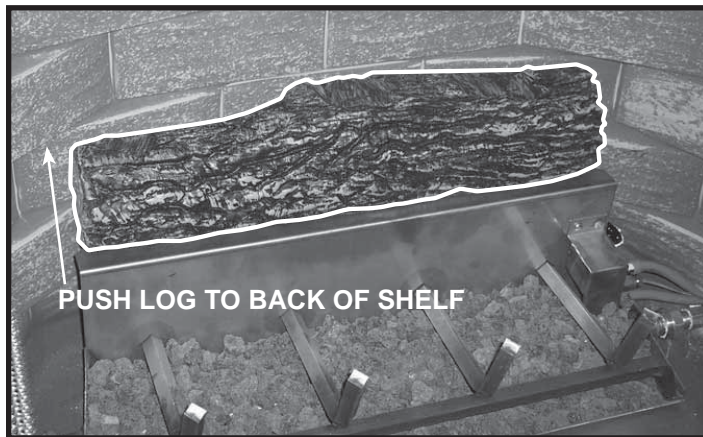

Figure 8.4 Place Rear Log - Carolina-42

- Place the left front log on the grate against the front of the grate. Fit notch in log to grate bar as shown below.

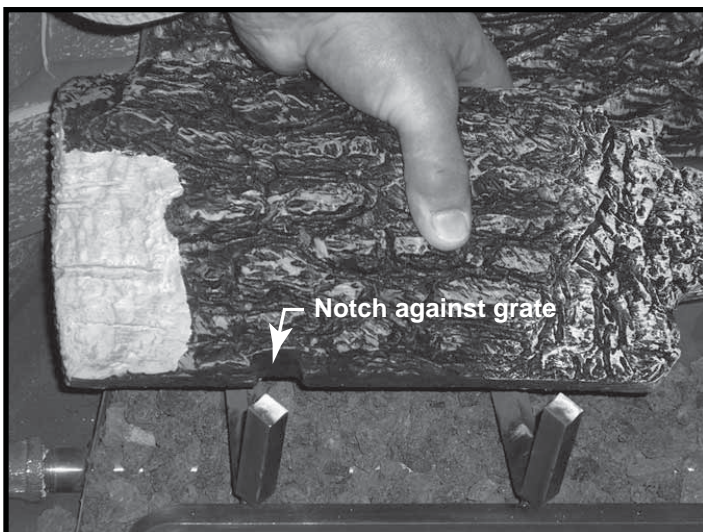

Figure 8.5 Place Left Front Log

- Place right front log on the grate against the front of the grate. Fit notches into the bottom of the log to position it as shown in Figure 8.6

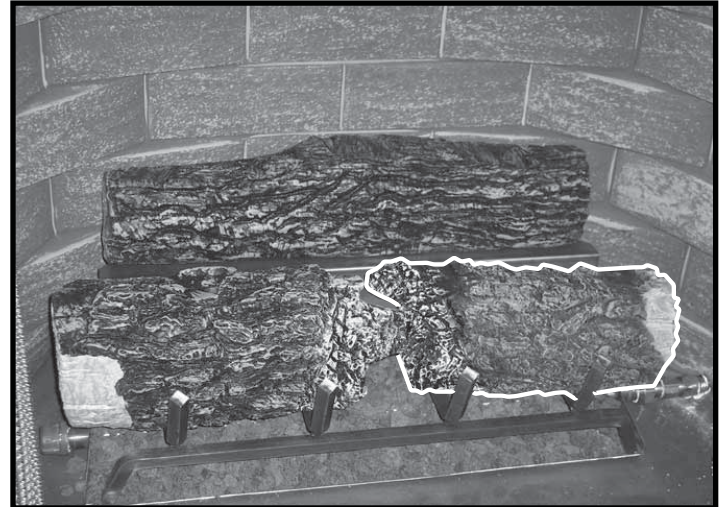

Figure 8.6 Place Right Front Log

- Place top left log on the indentations in the front left log and back log as shown in Figure 8.7.



Figure 8.7 Place Top Left Log

- Place the top right log on indentations in the front right log and back log as shown in Figure 8.8 .



Figure 8.8 Place Top Right Log



- Place left center log in the indentations on the front left log and the top left log as shown in Figure 8.9.



Figure 8.9 Place Left Center Log

- Place the center log on the indentations of the right front log and the back log as shown in Figure 8.10.



Figure 8.10 Place Center Log

- Place the right center long on the indentations of the right front log and the right rear log as shown in Figure 8.11.



Figure 8.11 Place Right Center Log

## F. Place Remaining Lava Rock

- After logs have been placed spread the remainder of the lava rock to cover the floor of the firebox.

## G. Install Firescreen

Firescreen must be installed if not installing optional screen door.

- Remove screen and screen rods from packaging.
- Lay the two sides of screen side by side, rings on top, handles meeting in the middle.
- Insert one screen rod through the rings on top. See Figure 8.11.
- Repeat for other screen.

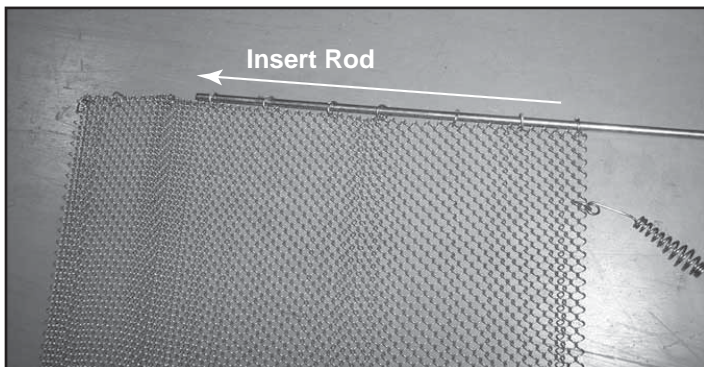

Figure 8.11 Insert Rod into Firescreen

- Remove two screws from the firebox top, set aside.

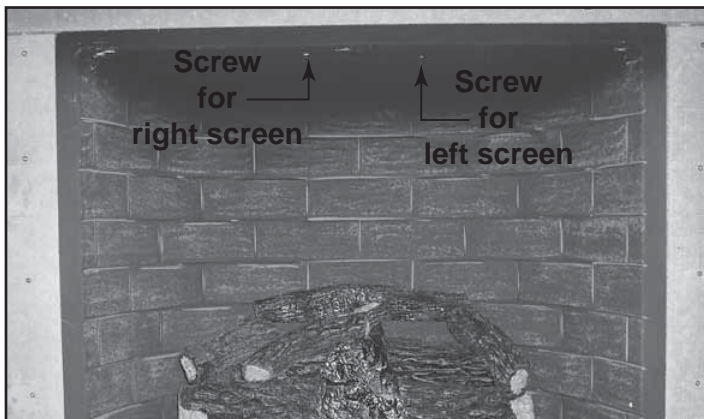

Figure 8.12 Remove Screws from Firebox Top

- Insert left end of the rod in the left screen (handle is on the right) into the hole in the upper left firebox side.

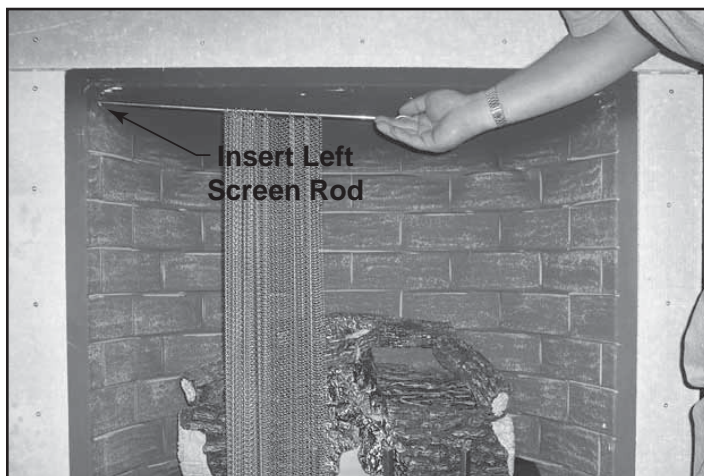

Figure 8.13 Insert Screen Rod

- Fasten rod with one of the screws removed from the firebox top, into the hole shown in Figure 8.12.

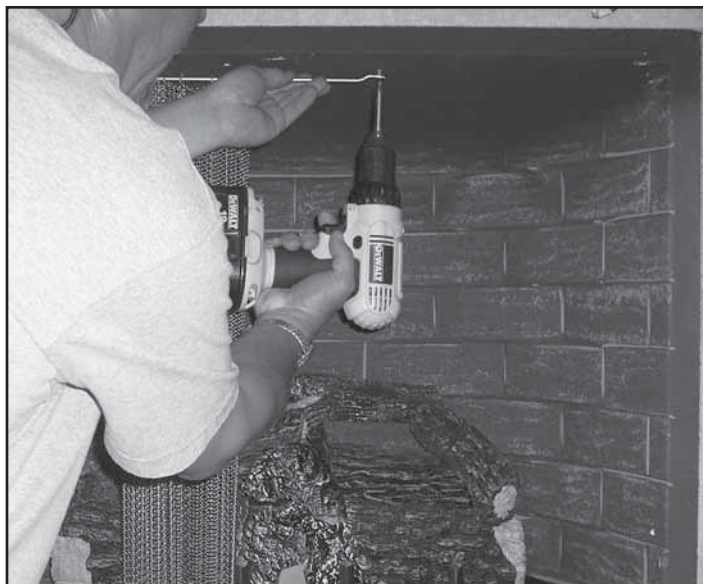

Figure 8.14 Fasten Screen Rod to Firebox Top

- Repeat with the right screen.

# 9 Operating Instructions

## A. Gas Fireplace Safety

### **WARNING**



#### **HOT SURFACES!**

Screens and other surfaces are hot during operation and cool down.

#### **Hot screens will cause burns.**

- Do not touch fireplace until it is cooled
  - NEVER allow children to touch fireplace
- Keep children away
  - CAREFULLY SUPERVISE children in same area as fireplace.
  - Alert children and adults to hazards of high temperatures.
- High temperatures may ignite clothing or other flammable materials.**
- Keep clothing, furniture, draperies and other combustibles away.

If you expect that small children or vulnerable adults may come into contact with this fireplace, the following precautions are recommended:

- Install a physical barrier such as:
  - A decorative firescreen.
  - Adjustable safety gate.
- Keep remote controls out of reach of children.
- Never leave children alone near a hot fireplace, whether operating or cooling down.
- Teach children to NEVER touch the fireplace.
- Consider not using the fireplace when children will be present.

Contact your dealer for more information, or visit: [www.hpba.org/safety-information](http://www.hpba.org/safety-information).

To prevent unintended operation when not using your fireplace for an extended period of time (summer months, vacations, trips, etc):

- Put module switch in the OFF position (Section 6.A.) to disable all fireplace controls or;
- Remove batteries from remote controls.
- Turn off wall controls.
- Unplug 6-volt adapter plug and remove batteries.
- Turn off gas shutoff valve.

## B. Your Fireplace

**WARNING! DO NOT** operate fireplace before reading and understanding operating instructions. Failure to operate fireplace according to operating instructions could cause fire or injury.

## C. Screens

- Screens are standard on the fireplace.
- Keep screens closed when in operation.

## D. Before Lighting Fireplace

Before operating this fireplace for the first time:

- Review proper placement of logs and lava rock.



## E. Lighting the Appliance

### Intermittent Pilot Ignition (IPI)

Lighting instructions may be found on the inside of the control box cover.

## FOR YOUR SAFETY READ BEFORE LIGHTING

**WARNING:** If you do not follow these instructions exactly, a fire or explosion may result causing property damage, personal injury or loss of life.

- A.** This appliance is equipped with an intermittent pilot ignition (IPI) device which automatically lights the burner. **DO NOT** try to light the burner by hand.
- Immediately call your gas supplier from a neighbor's phone. Follow the gas supplier's instructions.
  - If you cannot reach your gas supplier, call the fire department.
- B. BEFORE LIGHTING**, smell all around the appliance area for gas. Be sure to smell next to the floor because some gas is heavier than air and will settle on the floor.
- C. DO NOT** use this appliance if any part has been under water. Immediately call a qualified service technician to inspect the appliance and to replace any part of the control system and any gas control which has been under water.

#### WHAT TO DO IF YOU SMELL GAS

- **DO NOT** try to light any appliance.
- **DO NOT** touch any electric switch; do not use any phone in your building.

## WARNING:

**DO NOT CONNECT LINE VOLTAGE (110/120 VAC OR 220/240 VAC) TO THE CONTROL VALVE.**

Improper installation, adjustment, alteration, service or maintenance can cause injury or property damage. Refer to the owner's information manual provided with this appliance.

This appliance needs fresh air for safe operation and must be installed so there are provisions for adequate combustion and ventilation air.

If not installed, operated, and maintained in accordance with the manufacturer's instructions, this product could expose you to substances in fuel or fuel combustion which are known to the State of California to cause cancer, birth defects, or other reproductive harm.

Keep burner and control compartment clean. See installation and operating instructions accompanying appliance.

For additional information on operating your  
Hearth & Home Technologies fireplace, please refer to [www.fireplaces.com](http://www.fireplaces.com).

## CAUTION:

Hot while in operation. **DO NOT** touch. Keep children, clothing, furniture, gasoline and other liquids having flammable vapors away.

**DO NOT** operate the appliance with fixed glass assembly removed, cracked or broken. Replacement of the fixed glass assembly should be done by a licensed or qualified service person.

## NOT FOR USE WITH SOLID FUEL

For use with natural gas and propane. A conversion kit, as supplied by the manufacturer, shall be used to convert this appliance to the alternate fuel.

**Also Certified for Installation in a Bedroom or a Bedsitting Room.**

For assistance or additional information, consult a qualified installer, service agency or the gas supplier.

## LIGHTING INSTRUCTIONS (IPI)

1. This appliance is equipped with an ignition device which automatically lights the burner. **DO NOT** try to light the burner by hand.

**GAS  
VALVE**

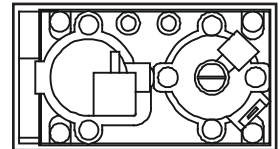

2. Wait five (5) minutes to clear out any gas. Then smell for gas, including near the floor. If you smell gas, **STOP!** Follow "B" in the Safety Information located on the left side of this label. If you do not smell gas, go to next step.
3. To light the burner:  
Equipped with wall switch: Turn ON/OFF switch to ON.  
Equipped with remote or wall control: Press ON or FLAME button.  
Equipped with thermostat: Set temperature to desired setting.
4. If the appliance does not light after three tries, call your service technician or gas supplier.

## TO TURN OFF GAS TO APPLIANCE

1. Equipped with wall switch: Turn ON/OFF switch to OFF.  
Equipped with remote or wall control: Press OFF button.  
Equipped with thermostat: Set temperature to lowest setting.
2. Service technician should turn off electric power to the control when performing service.

593-913G

Final inspection by \_\_\_\_\_

## F. After the Appliance is Lit

### Initial Break-in Procedure

When you light the appliance, you may notice that it produces heat which does have an associated odor or smell. This appliance should be run three to four hours on the initial start-up. Turn it off and let it cool completely. Run the appliance for an additional 12 hours. This will help cure the products used in the paint and logs.

***WARNING! Risk of Fire or Burns! Provide adequate clearance for service access. Due to high temperatures, the appliance should be located out of traffic and away from furniture and draperies.***

***WARNING! DO NOT place combustible objects in front of the fireplace. High temperatures may start a fire.***

# 10 Troubleshooting

With proper installation, operation, and maintenance your gas appliance will provide years of trouble-free service. If you do experience a problem, this troubleshooting guide will assist a qualified service technician in the diagnosis of a problem and the corrective action to be taken. This troubleshooting guide can only be used by a qualified service technician. Contact your dealer to arrange a service call by a qualified service technician.

## A. IntelliFire Plus™ Ignition System

| Symptom  | Possible Cause  | Corrective Action   |
|--|---|---|
| 1. Pilot won't light.<br>The ignitor/module makes noise, but no spark. | A. Incorrect wiring.  | Verify "S" wire (white) for sensor and "I" wire (orange) for ignitor are connected to correct terminals on module and pilot assembly.   |
|  | B. Loose connections or electrical shorts in the wiring.                    | Verify no loose connections or electrical shorts in wiring from module to pilot assembly. Verify connections underneath pilot assembly are tight; also verify igniter and flame sense wires are not grounding out to metal chassis, pilot burner, pilot enclosure, mesh screen if present, or any other metal object. |
|  | C. Ignitor gap is too large.  | Verify gap of igniter to right side of pilot hood. The gap should be approximately .17 in. or 1/8 in. (3 mm).   |
| 2. Pilot won't light, there is no noise or spark.                      | A. No power or transformer installed incorrectly or depleted batteries.     | Verify that transformer is installed and plugged into module. Check voltage of transformer at connection to module. Acceptable readings of a good transformer are between 6.4 and 6.6 volts AC. Battery power supply voltage must be at least 4 volts. If less than 4 volts, replace batteries.                       |
|  | B. A shorted or loose connection in wiring configuration or wiring harness. | Remove and reinstall the wiring harness that plugs into module. Verify there is a tight fit. Verify pilot assembly wiring to module. Remove and verify continuity of each wire in wiring harness. Replace any damaged components.   |
|  | C. Improper wall switch wiring.   | Verify that 110/VAC power is "ON" to junction box.  |
|  | D. Module not grounded.   | Verify black ground wire from module wire harness is grounded to metal chassis of appliance.  |
| 3. Pilot sparks, but Pilot will not light.                             | A. Gas supply.  | Verify that incoming gas line ball valve is "open". Verify that inlet pressure reading is within acceptable limits.   |
|  | B. Ignitor gap is too large.  | Verify gap of igniter to right side of pilot hood. The gap should be approximately .17 in. or 1/8 in. (3 mm).   |
|  | C. Module is not grounded.  | Verify module is securely grounded to metal chassis of appliance.   |
|  | D. Pilot valve solenoid.  | Verify that 1.5 to 1.8 VDC is supplied to pilot solenoid from module. If below 1.5 volts, replace module. If 1.5 volts or greater, replace valve.   |



## Troubleshooting (continued)

| Symptom   | Possible Cause   | Corrective Action  |
|---|--|--|
| 4. Pilot sparks, but Pilot will not light.  | A. Gas supply.   | Verify that incoming gas line shutoff valve is "open". Verify that inlet pressure reading is within acceptable limits.   |
|   | B. Ignitor gap is incorrect.                                   | Verify that spark gap from ignitor to pilot hood is .17 in. or 1/8 in (3 mm).  |
|   | C. Module is not grounded.                                     | Verify black ground wire from module wire harness is grounded to metal chassis of appliance.   |
|   | D. Module voltage output is low.                               | Verify battery voltage is at least 4 volts. Replace batteries if voltage is below 4.   |
| 5. Pilot lights but continues to spark, and burner will not ignite. (If the pilot continues to spark after the pilot flame has been lit, flame rectification has not occurred.) | A. A shorted or loose connection in flame sensing rod.         | Verify all connections to wiring diagram in manual. Verify connections underneath pilot assembly are tight. Verify connections are not grounding out to metal chassis, pilot burner, pilot enclosure or screen if present, or any other metal object.  |
|   | B. Poor flame rectification or contaminated flame sensing rod. | Verify correct pilot orifice is installed and gas inlet is set to pressure specifications. Check pilot for soot. Clean if necessary.   |
|   | C. Module is not grounded.                                     | Verify module is securely grounded to metal chassis of appliance. Verify that wire harness is firmly connected to the module.  |
|   | D. Damaged pilot assembly or contaminated flame sensing rod.   | Verify that ceramic insulator around the flame sensing rod is not cracked, damaged, or loose. Verify connection from flame sensing rod to white sensor wire. Clean flame sensing rod with emery cloth to remove any contaminants that may have accumulated on flame sensing rod. Verify continuity with a multimeter with ohms set at lowest range. Replace pilot if any damage is detected. |
|   | E. Module.   | Turn ON/OFF rocker switch or wall switch to OFF position. Remove ignitor wire "I" from module. Place ON/OFF rocker switch or wall switch in ON position. If there is no spark at "I" terminal module must be replaced. If there is a spark at "I" terminal, module is fine.  |
| 6. No pilot, no burner flame; 3 Flashes on the Module Red LED.  | A. False flame detected.                                       | Shut off gas and power immediately and call a technician.  |

# 11 Maintaining and Servicing the Appliance

Although the frequency of appliance servicing and maintenance will depend on use and the type of installation, a qualified service technician should perform an appliance check-up at the beginning of each heating season.

## WARNING

### Risk of injury or property damage

#### Before servicing:

- Turn off gas.
- Turn off electricity to appliance.
- Disable remote control, if one is present.
- Ensure appliance is completely cooled.

#### After Servicing:

- Replace any screen or barrier that was removed.

## WARNING



*Annual inspection by qualified technician recommended.*



#### Check:

- Condition of screen doors.
- Obstructions of combustion and ventilation air.
- Condition of logs.
- Condition of firebox.
- Burner ignition and operation.



#### Clean:

- Air passageways, control compartment.
- Burner, burner ports.

#### Risk of:

- Fire
- Delayed ignition or explosion
- Exposure to combustion fumes
- Odors

The logs, pilot assembly and front of appliance should be checked periodically for accumulation of soot. Clean pilot and front thoroughly with an emery cloth. Logs may be vacuumed gently.

## A. Maintenance and Service Tasks:

| Inspect                       | Maintenance Tasks  |
|-------------------------------|--|
| Doors and surrounds           | 1 Inspect for scratches and nicks that can lead to rust when exposed to weather  |
|                               | 2 Wipe face and finish material. Use a degreaser to remove soot buildup, if necessary.   |
| Valve compartment             | 1 Vacuum and wipe out dust, cobwebs, debris or pet hair. Use caution when cleaning these areas. Screw tips that have penetrated the sheet metal are sharp and should be avoided.   |
|                               | 2 Remove any foreign objects.  |
|                               | 3 Verify unobstructed air circulation.   |
| Logs                          | 1 Inspect for broken, damaged or missing logs. Replace as necessary.   |
|                               | 2 Logs will accumulate soot. Periodically brush soot from the logs with a paint brush or vacuum.   |
| Firebox                       | 1 Inspect for paint condition, warping, corrosion or perforation. Sand and repaint as necessary.   |
|                               | 2 Replace appliance if firebox has been perforated.  |
|                               | 3 Check caulking around gas line and pilot assembly and replace as necessary to prevent water infiltrating the appliance.  |
| Burner ignition and operation | 1 Verify burner is properly secured to firebox bottom.   |
|                               | 2 Clean off burner top, inspect for plugged ports, corrosion or deterioration.   |
|                               | 3 Verify air shutter is clear of dust and debris.  |
|                               | 4 Inspect orifice for soot, dirt or corrosion.   |
|                               | 5 Verify manifold and inlet pressures. Adjust regulator as required.   |
|                               | 6 Inspect pilot flame strength. Clean or replace orifice as necessary.   |
|                               | 7 Inspect thermocouple/thermopile or IPI sensor rod for soot, corrosion and deterioration. Clean with emery cloth or replace as required.  |
| Remote controls               | 1 Verify operation of remote.  |
|                               | 2 Replace batteries in remote transmitters.  |
|                               | 3 If appliance will not be used for a long period of time, verify batteries have been removed from battery back-up in IPI systems to prevent premature battery failure or leaking. |



# 12 Reference Materials

## A. Appliance Dimension Diagram

Dimensions are actual appliance dimensions. Use for reference only. For framing dimensions and clearances refer to Section 3.

### CARODG36I, CARODG36IL

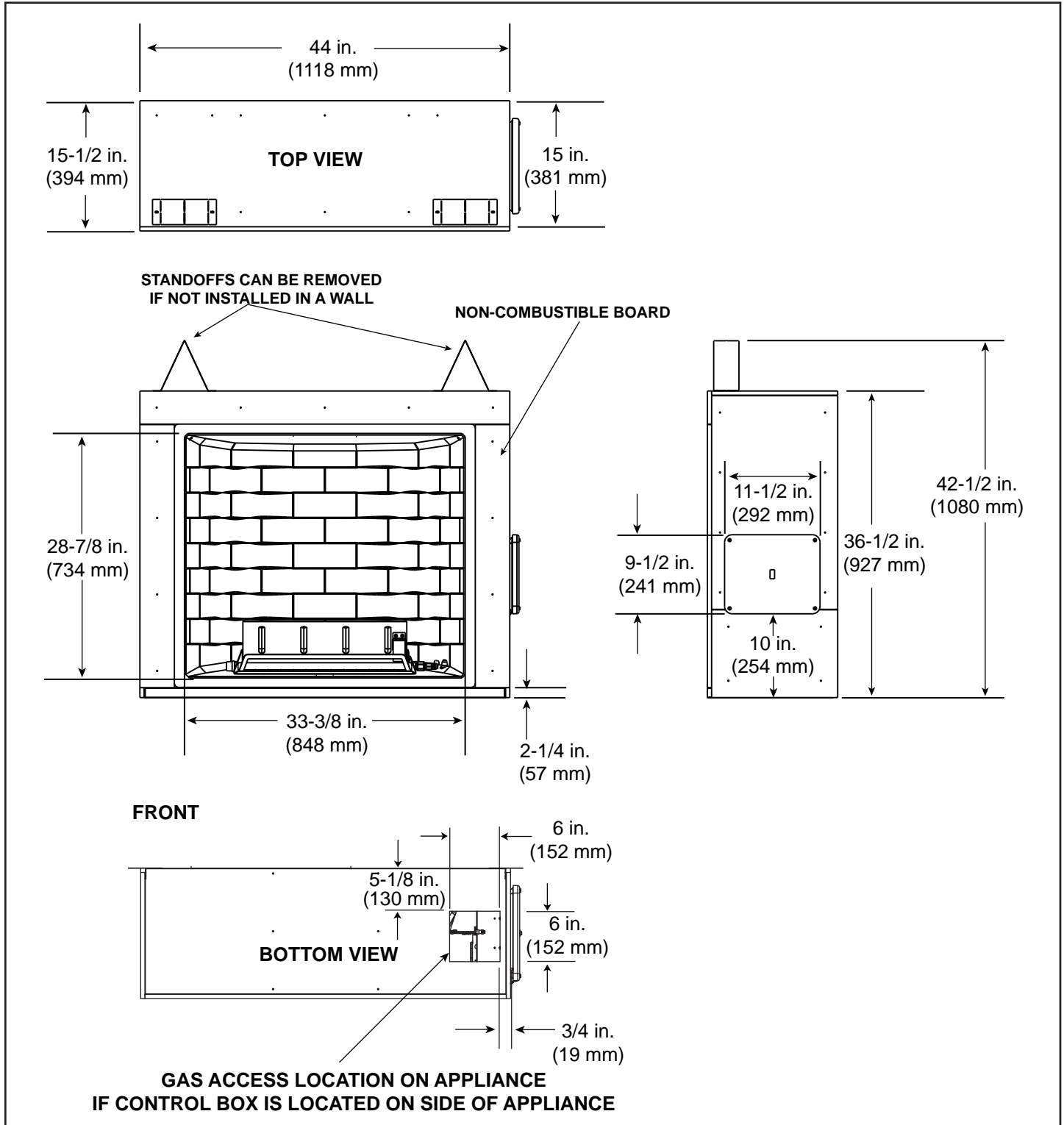

Figure 12.1 Appliance Dimensions - CARODG36I, CARODG36IL

CARODG42I, CARODG42IL

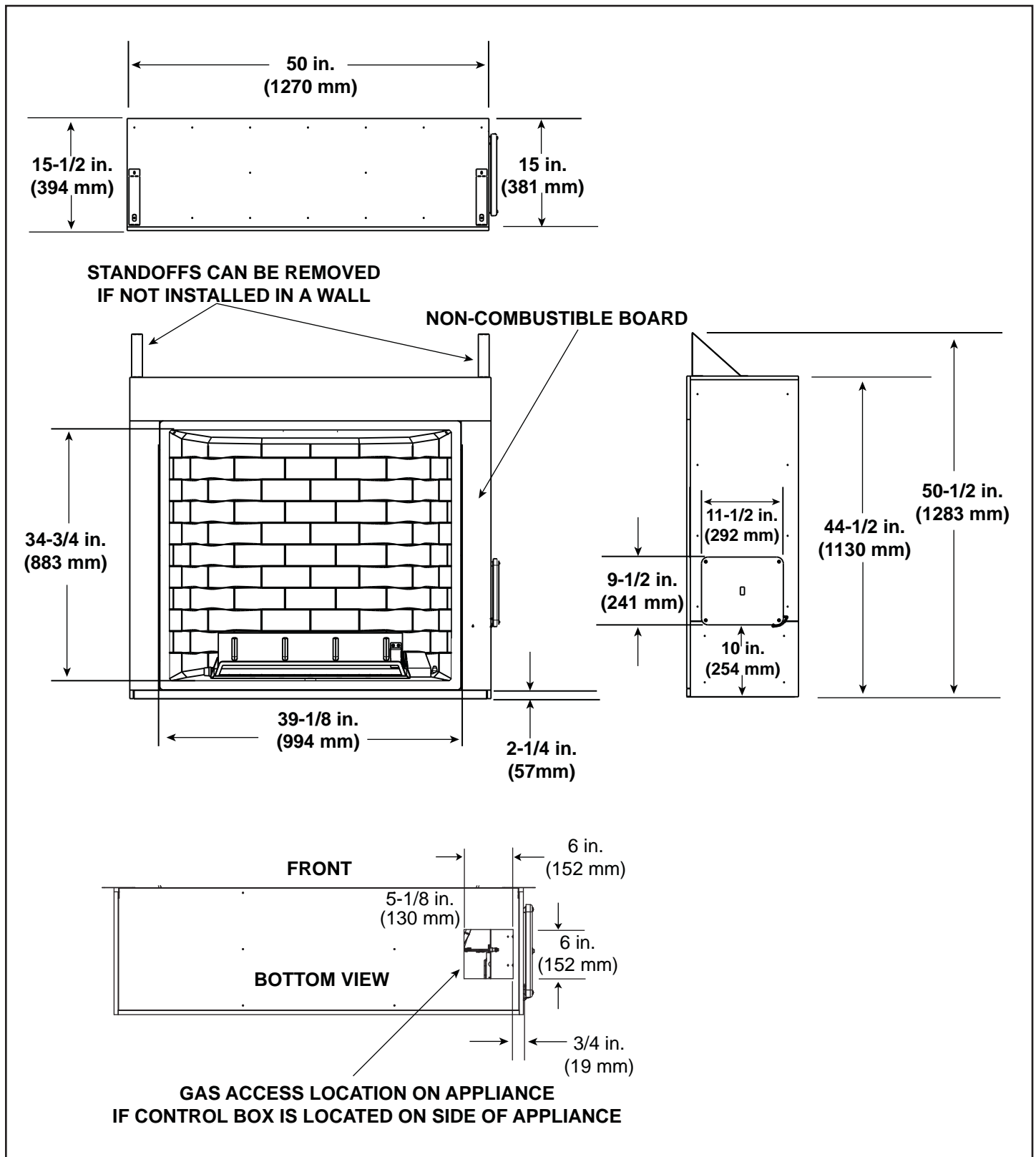
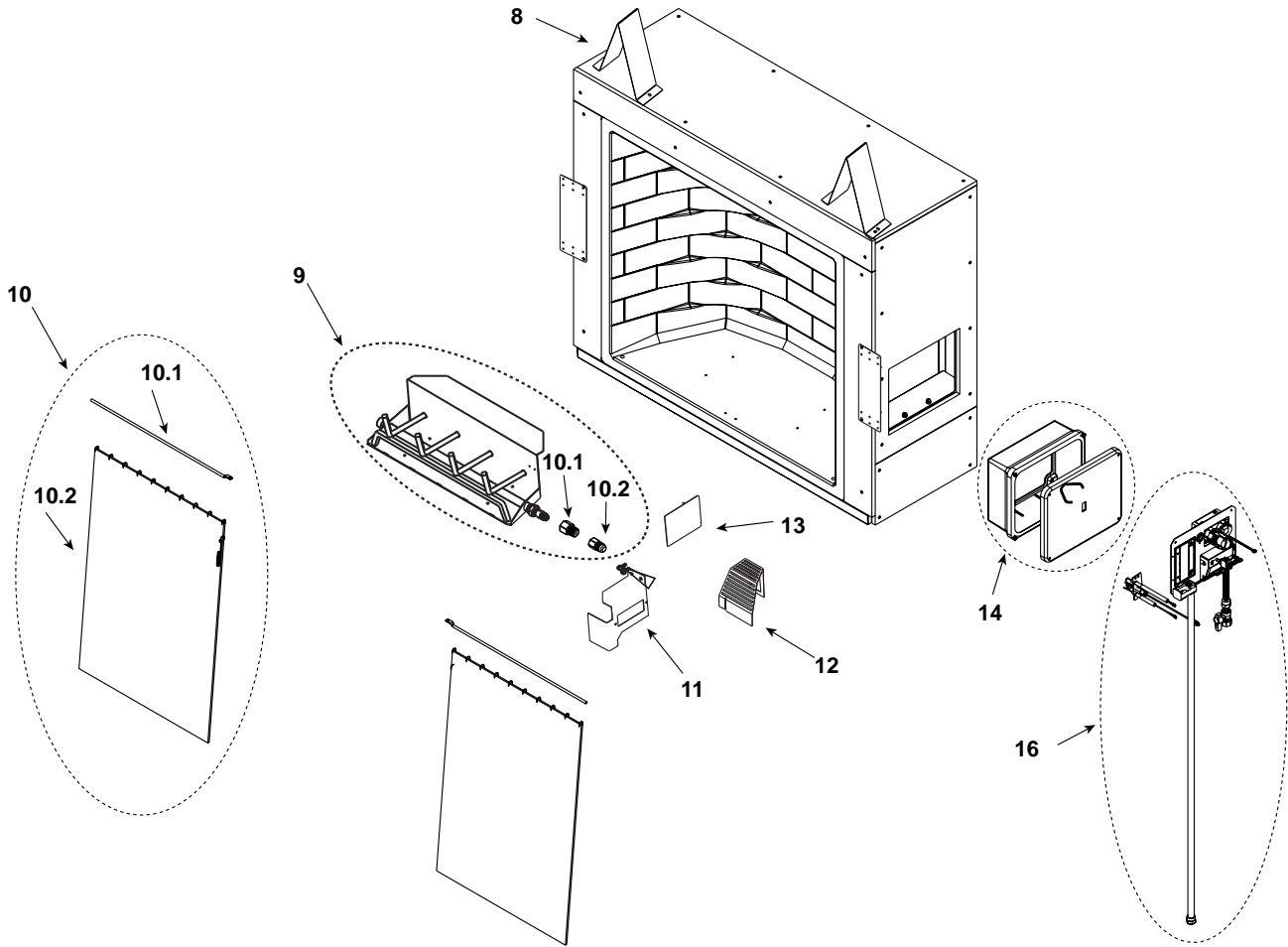
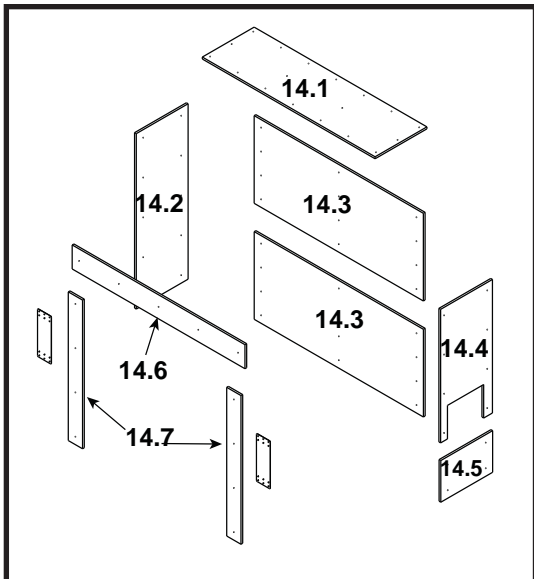

Figure 12.2 Appliance Dimensions - CARODG42I, CARODG42IL



**#15 Non Combustible Board**



**Log Set Assembly**

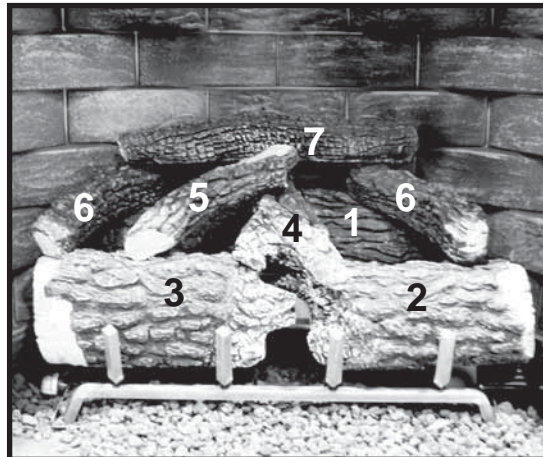

Part number list on following page.

# CARODG36I, CARODG36IL

IMPORTANT: THIS IS DATED INFORMATION. When requesting service or replacement parts for your appliance please provide model number and serial number. All parts listed in this manual may be ordered from an authorized dealer.



**Stocked  
at Depot**

| ITEM | DESCRIPTION                         | COMMENTS          | PART NUMBER   |   |
|------|-------------------------------------|-------------------|---------------|---|
|      | Log Set Assembly                    |                   | 4066-017      | Y |
| 1    | Log 1, Back                         |                   | 4066-320      |   |
| 2    | Log 2, Front Right                  |                   | 4066-319      |   |
| 3    | Log 3, Front Left                   |                   | 4066-318      |   |
| 4    | Log 4, Top Inside Right             |                   | 4066-317      |   |
| 5    | Log 5, Top Inside Left              |                   | 4066-316      |   |
| 6    | Log 6, Top Outside Left             | Qty 2 req         | 4066-315      |   |
| 7    | Log 8, Top Back                     |                   | 4066-313      |   |
| 8    | Standoff                            | Qty 2 req         | 4066-119      |   |
| 9    | Burner/Grate Assembly NG            | Pre SN 0022401504 | SRV4066-019   | Y |
|      |                                     | Post SN 002401504 | 4066-019      | Y |
|      | Burner/Grate Assembly LP            | Pre SN 0022401504 | SRV4066-018   | Y |
|      |                                     | Post SN 002401504 | 4066-018      | Y |
| 9.1  | Orifice, NG                         |                   | 4066-154      |   |
|      | Orifice, LP                         |                   | 4066-155      |   |
| 9.2  | Connector                           |                   | 4066-156      |   |
| 10   | Screen Rod Assembly                 | Qty 2 req         | 4066-022      | Y |
| 10.1 | Screen Rod                          | Qty 2 req         | 4066-305      | Y |
| 10.2 | Screen Assembly                     | Qty 2 req         | 4066-023      | Y |
| 11   | Pilot Bracket                       |                   | 4067-112      |   |
| 12   | Pilot Shield                        |                   | 4066-127      |   |
| 13   | Heat Shield                         |                   | 4067-113      |   |
| 14   | Control Box Assembly                |                   | 4066-325      | Y |
| 15   | Non-combustible Board Assembly      |                   |               |   |
| 15.1 | Top                                 |                   | 4066-120      |   |
| 15.2 | Left Side                           |                   | 4066-121      |   |
| 15.3 | Back                                | Qty 2 req         | 4066-123      |   |
| 15.4 | Right Side                          |                   | 4066-122      |   |
| 15.5 | Lower Right                         |                   | 4066-126      |   |
| 15.6 | Upper Front                         |                   | 4066-124      |   |
| 15.7 | Front Sides                         | Qty 2 req         | 4066-125      |   |
|      | Touch up Paint Fiber                |                   | STRATFORD-KIT |   |
|      | Patch Kit, Fiber                    |                   | SRV-PACK      |   |
|      | Electric Conversion Kit to AC Power |                   | ELEC-CARODG   |   |
|      | Conversion Kit NG                   |                   | NGK-CARODG36  | Y |
|      | Conversion Kit LP                   |                   | LPK-CARODG36  | Y |
|      | Pilot Orifice NG                    |                   | 593-528       | Y |
|      | Pilot Orifice LP                    |                   | 593-527       | Y |
|      | Regulator NG                        |                   | NGK-DXV-50    | Y |
|      | Regulator LP                        |                   | LPK-DXV-50    | Y |

Additional service part numbers appear on following page.



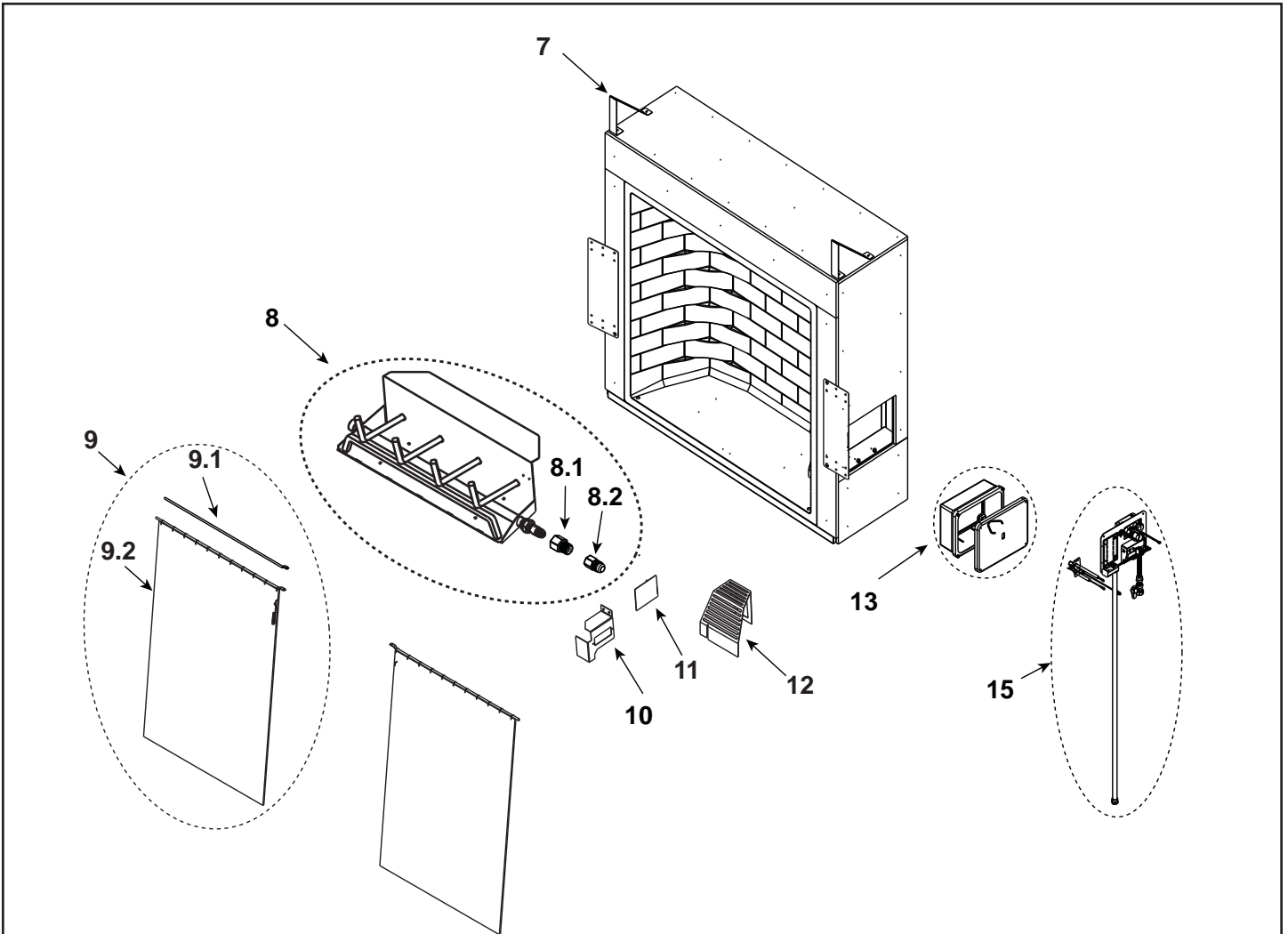

**#14 Non Combustible Board**

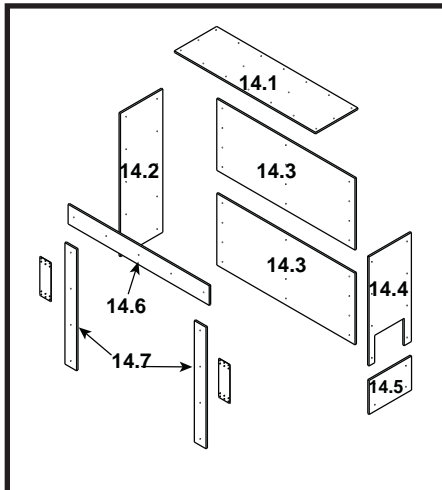

**Log Set Assembly**

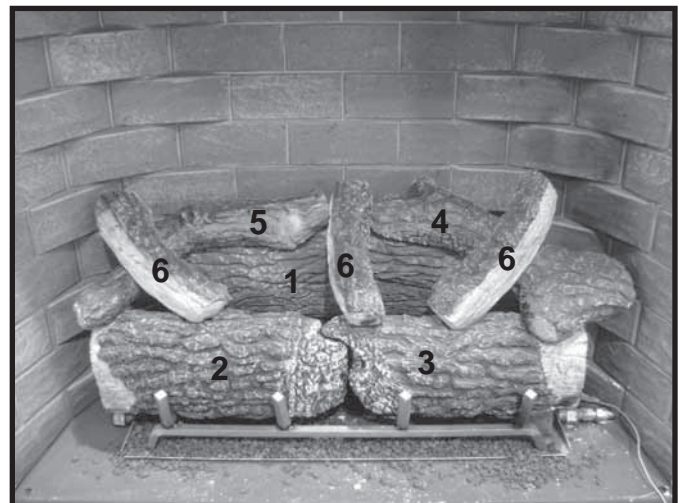

Part number list on following page.

# CARODG42I, CARODG42IL

IMPORTANT: THIS IS DATED INFORMATION. When requesting service or replacement parts for your appliance please provide model number and serial number. All parts listed in this manual may be ordered from an authorized dealer.



**Stocked  
at Depot**

| ITEM | DESCRIPTION                         | COMMENTS  | PART NUMBER   |   |
|------|-------------------------------------|-----------|---------------|---|
|      | Log Set Assembly                    |           | 4067-017      | Y |
| 1    | Log 1, Rear Log                     |           | 4067-313      |   |
| 2    | Log 2, Left Front                   |           | 4067-314      |   |
| 3    | Log 3, Right Front                  |           | 4067-315      |   |
| 4    | Log 4, Top Right                    |           | 4067-316      |   |
| 5    | Log 5, Top Left                     |           | 4067-317      |   |
| 6    | Log 6                               | Qty 3 req | 4067-319      |   |
| 7    | Standoff                            | Qty 2 req | 4067-119      |   |
| 8    | Burner/Grate Assembly NG            |           | 4067-019      | Y |
|      | Burner/Grate Assembly LP            |           | 4067-018      | Y |
| 8.1  | Orifice, NG                         |           | 4067-154      | Y |
|      | Orifice, LP                         |           | 4067-155      | Y |
| 8.2  | Connector                           |           | 4066-156      |   |
| 9    | Screen Rod Assembly                 | Qty 2 req | 4067-022      | Y |
| 9.1  | Screen Rod                          | Qty 2 req | 4067-305      |   |
| 9.2  | Screen Assembly                     | Qty 2 req | 4067-023      | Y |
| 10   | Pilot Bracket                       |           | 4067-112      |   |
| 11   | Heat Shield                         |           | 4067-113      |   |
| 12   | Pilot Shield                        |           | 4066-127      |   |
| 13   | Control Box Assembly                |           | 4066-325      | Y |
| 14   | Non-combustible Board               |           |               |   |
| 14.1 | Top                                 |           | 4067-120      |   |
| 14.2 | Left Side                           |           | 4067-121      |   |
| 14.3 | Back                                | Qty 2 req | 4067-123      |   |
| 14.4 | Right Side                          |           | 4067-122      |   |
| 14.5 | Lower Right                         |           | 4066-126      |   |
| 14.6 | Upper Front                         |           | 4067-124      |   |
| 14.7 | Front Sides                         | Qty 2 req | 4067-125      |   |
|      | Bracket, Junction Box               |           | 4066-116      |   |
|      | Electric Conversion Kit to AC Power |           | ELEC-CARODG   |   |
|      | Patch Kit, Fiber                    |           | SRV-PACK      |   |
|      | Touch up Paint, Fiber               |           | STRATFORD-KIT |   |
|      | Conversion Kit NG                   |           | NGK-CARODG42  | Y |
|      | Conversion Kit LP                   |           | LPK-CARODG42  | Y |
|      | Pilot Orifice NG                    |           | 593-528       | Y |
|      | Pilot Orifice LP                    |           | 593-527       | Y |
|      | Regulator NG                        |           | NGK-DXV-50    | Y |
|      | Regulator LP                        |           | LPK-DXV-50    | Y |

Additional service part numbers appear on following page.



Beginning Manufacturing Date: Feb 2010  
Ending Manufacturing Date: \_\_\_\_\_

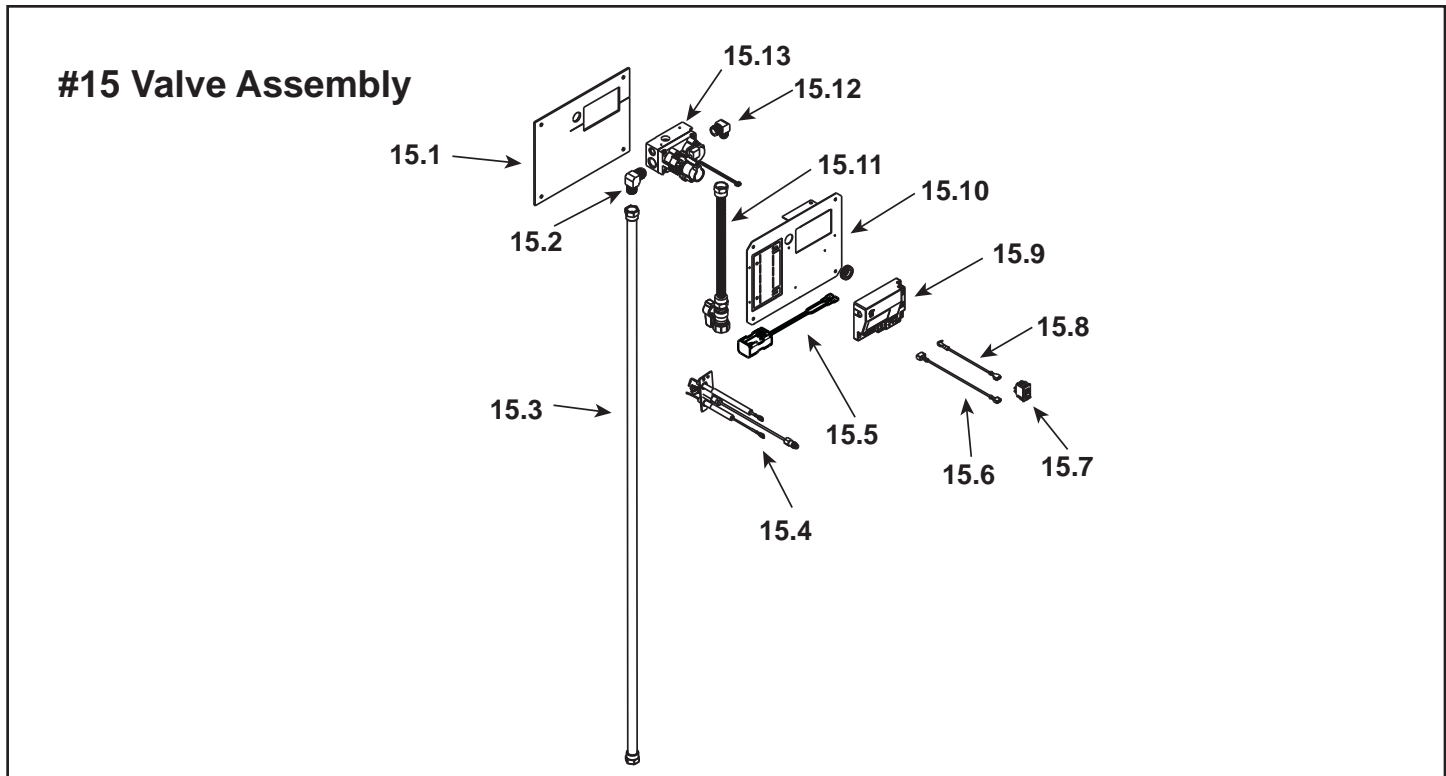

IMPORTANT: THIS IS DATED INFORMATION. When requesting service or replacement parts for your appliance please provide model number and serial number. All parts listed in this manual may be ordered from an authorized dealer.



**Stocked at Depot**

| ITEM  | DESCRIPTION                            | COMMENTS | PART NUMBER |   |
|-------|--|----------|-------------|---|
| 15    | Valve Assembly NG                      |          | 4066-026    |   |
|       | Valve Assembly LP                      |          | 4066-027    |   |
| 15.1  | Gasket , Pilot Bracket                 |          | 4066-328    |   |
| 15.2  | 90 Degree Elbow                        |          | 4042-314    |   |
| 15.3  | Flex Line, 1/2 inch SS, 84 inches long |          | 4021-696    | Y |
| 15.4  | Pilot Assembly NG                      |          | 4021-628    | Y |
|       | Pilot Assembly LP                      |          | 4021-629    | Y |
|       | Pilot Tube                             |          | 4021-705    | Y |
| 15.5  | Battery Pack**                         |          | 4067-223    | Y |
| 15.6  | Wire Assembly                          |          | 4021-710    | Y |
| 15.7  | On/ Off Switch                         |          | 060-511     | Y |
| 15.8  | Wire Assembly                          |          | 4021-697    | Y |
| 15.9  | Module                                 |          | 2166-307    | Y |
| 15.10 | Valve Bracket                          |          | 4066-115    |   |
| 15.11 | Flex Ball Valve Assembly               |          | 2078-022    | Y |
| 15.12 | Male Elbow                             |          | 4021-045    |   |
| 15.13 | Valve NG                               |          | 2166-302    | Y |
|       | Valve LP                               |          | 2166-303    | Y |
|       | Wire Harness                           |          | 2166-304    | Y |

\*\*Fuse for battery pack can be sourced locally, not a warranty item. Specs are 500mA~10A 3/4" long

## C. Warranty

### Outdoor Lifestyles by Hearth & Home Technologies, Inc.™ Limited Warranty

Hearth & Home Technologies, Inc. ("HHT") extends the following warranty for all Outdoor Lifestyles by HHT™ brand products ("Products") that are purchased from an HHT authorized dealer.

#### **WARRANTY COVERAGE:**

HHT warrants to the original owner of the Product at the site of installation, and to any transferee taking ownership of the Product at the site of installation within one year following the date of original purchase, that the Product will be free from defects in materials and workmanship at the time of manufacture. After installation, if covered components manufactured by HHT are found to be defective in materials or workmanship during the applicable warranty period, HHT will, at its option, repair or replace the covered components. This warranty is subject to conditions, exclusions and limitations as described below.

#### **WARRANTY PERIOD:**

The warranty period runs for one year, beginning on the earlier of: (i) the date of invoice for the Product; (ii) in the case of new home construction, the date of first occupancy of the residence or six months after the date of sale of the Product by an HHT authorized dealer, whichever occurs first; or (iii) the date 24 months following the date of Product shipment from HHT, regardless of the invoice or occupancy date.

#### **WARRANTY CONDITIONS:**

- This warranty only covers Products that are purchased through an HHT authorized dealer or distributor. A list of HHT authorized dealers is available on the HHT branded websites.
- This warranty is only valid while the Product remains at the site of original installation.
- Contact your installing dealer for warranty service. If the installing dealer is unable to provide necessary parts, contact the nearest HHT authorized dealer or supplier. Additional service fees may apply if you are seeking warranty service from a dealer other than the dealer from whom you originally purchased the Product.
- Check with your dealer in advance for any costs to you when arranging a warranty call. Travel and shipping charges for parts are not covered by this warranty.

#### **WARRANTY EXCLUSIONS:**

This warranty does not cover the following:

- Changes in surface finishes as a result of normal use. As a heating appliance, some changes in color of interior and exterior surface finishes may occur; this is not a flaw and not covered under warranty.
- Damage to printed, plated, or enameled surfaces caused by fingerprints, accidents, misuse, scratches, melted items, or other external sources and residues left on surfaces from the use of abrasive cleaners or polishes.
- Repair or replacement of parts that are subject to normal wear and tear during the warranty period. These parts include: paint, firebricks, grates, flame guides and the discoloration of glass.
- Minor expansion, contraction, or movement of certain parts causing noise. These conditions are normal and complaints related to this noise are not covered by this warranty.



## C. Warranty (*continued*)

- Damages resulting from: (1) failure to install, operate, or maintain the Product in accordance with the installation instructions, operating instructions, and listing agent identification label furnished with the Product; (2) failure to install the Product in accordance with local building codes; (3) shipping or improper handling; (4) improper operation, abuse, misuse, continued operation with damaged, corroded or failed components, accident, or incorrectly performed repairs; (5) inadequate ventilation, negative pressure or environmental conditions, including, without limitation: hail, snow, ice, fallen branches, flooding, water damage and fading of color; (6) use of fuels other than those specified in the operating instructions; (7) installation or use of components not supplied with the Product or any other components not expressly authorized and approved by HHT; (8) modification of the Product not expressly authorized and approved by HHT in writing; and/or (9) interruptions or fluctuations of electrical power supply to the Product.
- Non-HHT venting components, hearth components or other accessories used in conjunction with the Product.
- Any part of a pre-existing fireplace system in which an insert or a decorative gas appliance is installed.
- The Product's capability to heat the desired space. Information is provided to assist the consumer and the dealer in selecting the proper appliance for the application. Consideration must be given to the Product's location and configuration and environmental conditions.

### **This warranty is void if:**

- The Product has been over-fired or operated in atmospheres contaminated by chlorine, fluorine, or other damaging chemicals. Over-firing can be identified by, but not limited to, warped plates or tubes, rust colored cast iron, bubbling, cracking and discoloration of steel or enamel finishes and cracking or spalling of refractory or cementitious materials.
- The Product is subjected to prolonged periods of dampness, condensation, ice or snow.
- There is any damage to the Product or other components due to water or weather damage which is the result of, but not limited to, improper chimney or venting installation.

### **LIMITATIONS OF LIABILITY:**

Repair or replacement in accordance with the provisions of this warranty will be the owner's exclusive remedy for and will constitute HHT's sole obligation under this warranty, under any other warranty (express or implied), or in contract, tort or otherwise; provided, however, that if HHT is unable to provide repair or replacement in an expedient and cost effective manner, HHT may discharge all such obligations by refunding the purchase price of the Product. No employee, agent, dealer, or other person is authorized to give any warranty on behalf of HHT. TO THE EXTENT ALLOWED BY LAW, HHT MAKES NO OTHER WARRANTY, EXPRESS OR IMPLIED, INCLUDING ANY WARRANTY OF MERCHANTABILITY OR FITNESS FOR A PARTICULAR PURPOSE. HHT WILL NOT BE LIABLE FOR ANY CONSEQUENTIAL OR INCIDENTAL DAMAGES ARISING OUT OF DEFECTS IN OR USE OF THE PRODUCTS. Some states do not allow exclusions or limitation of incidental or consequential damages, so these limitations may not apply to you. This warranty gives you specific rights; you also may have other rights, which vary from state to state. The duration of any implied warranty is limited to the duration of the warranty period specified herein.

D. Contact Information



**Please contact your Outdoor Lifestyles dealer with any questions or concerns.**  
For the number of your nearest Outdoor Lifestyles dealer, please visit [www.hearthnhome.com](http://www.hearthnhome.com).

**- NOTES -**

---

---

---

---

---

---

---

---

---

---

|  |   |  |
|--|---|--|
| <b>CAUTION</b>   |   |  |
|  | <b>DO NOT DISCARD THIS MANUAL</b>   |  |
| Important operating and maintenance instructions included. | • Read, understand and follow these instructions for safe installation and operation. |  |

This product may be covered by one or more of the following patents: (United States) 5328356, 5601073, 5613487, 5647340, 5890485, 5941237, 5947112, 5996575, 6006743, 6019099, 6053165, 6145502, 6170481, 6374822, 6484712, 6601579, 6769426, 6863064, 7077122, 7098269, 7258116, 7470729 or other U.S. and foreign patents pending.

2000-945

Printed in U.S.A. - Copyright 2011

## Free Manuals Download Website

<http://myh66.com>

<http://usermanuals.us>

<http://www.somanuals.com>

<http://www.4manuals.cc>

<http://www.manual-lib.com>

<http://www.404manual.com>

<http://www.luxmanual.com>

<http://aubethermostatmanual.com>

Golf course search by state

<http://golfingnear.com>

Email search by domain

<http://emailbydomain.com>

Auto manuals search

<http://auto.somanuals.com>

TV manuals search

<http://tv.somanuals.com>