



Model. HQL170WR/200NR

User's Guide

* The above image may look different from the real product.

Download from www.Somanuals.com. All Manuals Search And Download.



FCC Information

User Instructions

The Federal Communications Commission Radio Frequency Interference Statement includes the following warning :

NOTE : This equipment has been tested and found to comply with the limits for a Class B digital device pursuant to Part 15 of the FCC Rules.

These limits are designed to provide reasonable protection against harmful interference in a residential installation. This equipment generates, uses, and can radiate radio frequency energy and, if not installed and used in accordance with the instructions, may cause harmful interference to radio communications. However, there is no guarantee that interference will not occur in a particular installation.

If this equipment does cause harmful interference to radio or television receptions, which can be determined by turning the equipment off and on, the user is encouraged to try to correct the interference by one or more of the following measures :

- Reorient or relocate the receiving antenna.
- Increase the separation between the equipment and receiver.
- Connect the equipment into an outlet on a circuit different from that to which the receiver is connected.
- Consult the dealer or an experienced radio/TV technician for assistance.

User Information

Changes or modifications not expressly approved by the party responsible for compliance could void the user's authority to operate the equipment.

Connecting of peripherals requires the use of grounded shielded signal cables.



Important Tips

Image Retention Effect(Image Sticking) —

1. Cause :

- If LCD TV displays the same pattern for a long period of time, Image Retention Effect may develop due to the LCD structure.
- This is a common phenomenon that occurs in all LCD products on current market.

2. Prevention :

- To avoid this matter, use the product after reducing brightness and contrast, especially when a still image is displaying for a long time. (Example : Contrast 25, Brightness 25 - *See the page 34*)
Once Image retention occurs, change the mode into Video mode which displays more motion pictures. It will help reduce this effect, but cannot completely eliminate the effect once it occurs.
When a fixed pattern is displayed often, screen brightness may get worse.

3. Solution :

- Displaying a full white pattern for around 10 hours might help reduce latent image effect temporarily.
- It is not possible to permanently prevent Image Sticking Effect using current technology.

4. Notice :

- It is very important to notify every buyer/customer of this information and all distributors/buyers/customers should be fully aware of this.
- A manufacturer cannot provide a technical support of Image Sticking Effect of LCD TV. And Warranty does not include Image Sticking Effect.

Image Sticking Precaution

Still Image Wide/4:3 in Motion Image —

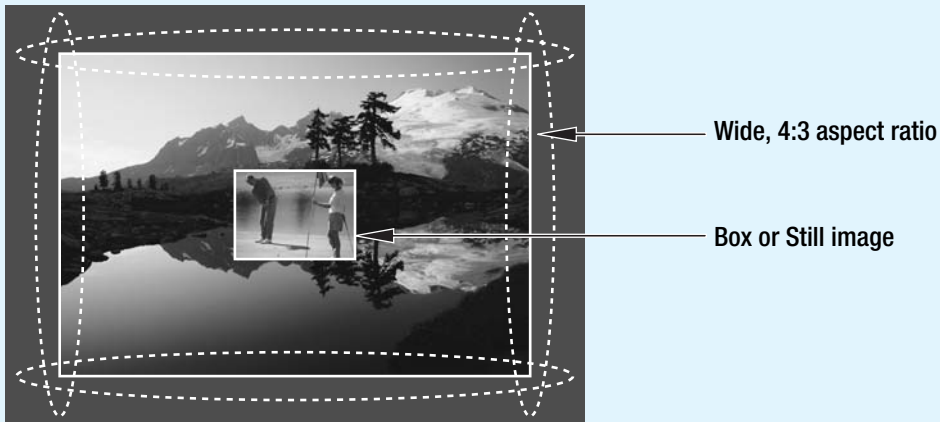

- **Precaution :**

- Image Sticking could be come from Still Image and Boundary line for a long time display and Brightness gap in Boundary.
- This Matter(Image Sticking) is same thing under the other LCD TV's Company.
- Still Image/Letter in watching TV also will be effect to Image sticking.
- *This matter(Image Sticking) is out of warranty.



Features

A Wide Array of Screen Settings

You can choose different screen settings depending on the type of program you are watching or the surrounding conditions (the lighting or the outside weather conditions).

You can switch among Dynamic, Mild and Standard, or you can configure the screen settings for yourself.

A Wide Array of Sound Settings

You can choose an optimal sound setting for the type of program you are watching.

You can switch among Standard, Music, Movie and News, or you can configure the settings for yourself.

Various Screen Sizes

Standard (4:3), Widescreen (16:9) and Zoom are available.

PIP (Picture In Picture), POP (Picture Of Picture) are Multi(9 screens) functions are provided.

Teletext Function

You can display teletext information at any time on your TV.

Surround Audio Function

You can listen to dynamic and surround sound only with ordinary speakers.

Auto ON/OFF Function

This function allows you to turn on/off your LCD TV at the preset time.

Table of Contents

General Information

Safety Precaution	5
Contents of the Package	11
Separately Sold Products	11
How to Use the Kensington Security Slot	12
How to Use the Rear Cap and Cable Holder	13
How to Adjust the View Angle	14
How To Install Wall Mount Support	15
Parts Names and Functions	17
Remote Control	19

Connections

Connecting Indoor/Outdoor TV Antenna(UHF/VHF)	23
Connecting to the Antenna Input Connection on the External Equipment	24
Connecting a VCR, Cable/Satellite Receiver	25
Connecting a DTV Receiver or DVD Player	26
Playing Back a Tape Recorded On a Camcorder	27
Connecting to a PC	28
Resolutions Supported in PC	29
Scart Connection to the External Input/Output	30
Scart Pin Specifications	31

Picture Setup

How to Select the Picture Mode	33
How to Set the Desired Picture	34
How to Set Noise Reduction	35
How to Set PIP [Mode]	36
How to Set POP [Mode]	36
How to Set Multi [Mode]	37
How to Freeze Picture	38
How to Select the Aspect Ratio	39

Audio Setup

How to Select the Volume, Balance and Mute	41
--	----

How to Set the Audio Mode(Equalize)	42
How to Set the Desired Audio	43
How to Listen to Stereo Sound / Dual Sound	44
How to Select the Surround	46
How to Select AVL	47
How to Select the Sound Swap	48

PC Setup

How to Select the Color Mode	51
How to Select the Auto Adjust	52
How to Set the Geometry	53

TV Setup

How to Store Program Automatically	55
How to Set Manual Store	56
How to Directly Select the PR LIST	59

Option Setup

Choosing Your Language	61
How to Set OSD(On-Screen-Display) Display Time	62
How to Select the OSD Background	63
How to Set Sleep Time	64
How to Set Clock	65
How to Set On /Off Time	66
How to Set Key-Lock	68
Displaying Information	69
Teletext Feature	71
Displaying the Teletext Information	72
Selecting Display Options	72

Appendix

Troubleshooting	75
Care and Cleaning	77
Product Specifications	78



Safety Precaution

The contents of this section are provided for the safety of users and their property. Please read the instructions carefully before using.

WARNING

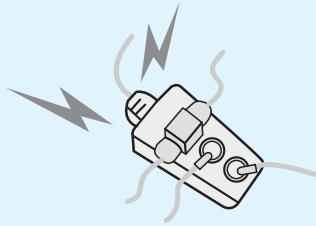

Do not connect multiple electrical appliances to a single outlet.
- It may cause a fire due to overheating from the outlet.

If there is a persistent accumulation of dusts or water on the plug, please make sure to wipe it off using a dry cloth.
- It may cause a fire or an electric shock.



WARNING

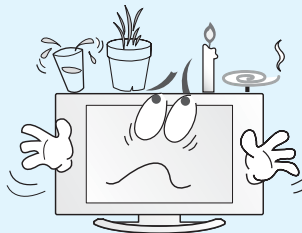



Do not put a water bowl, vase, candle, bug repellent, cigarette, plants, or heavy thing on the LCD TV.
- It may cause electric shock or fire and also heavy things may cause injury when they fall.

Do not install in a place where there is oil, smoke, excessive humidity, or where water may be sprinkled, dripped, splashed on it.
- This may cause electric shock or fire.



Safety instructions are divided into “Warning” and “Alert”. Their meanings are as follows.

-  This icon is intended to alert the user to the presence of potential danger and important operating instructions.
-  **Warning** : When there is a possibility of serious injury or death if not observed.
-  **Alert** : When there is a possibility of slight injury or product damage if not observed.

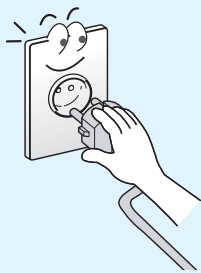

Firmly plug in the power cord so that it does not pull out.
- An unstable connection may cause fire.

Do not use a damaged power cord or plug, or loose outlet.
- They may cause electric shock or fire.

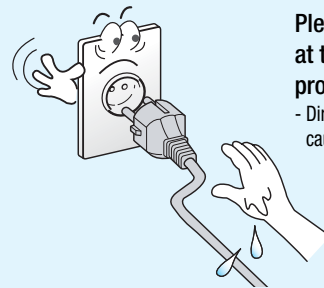
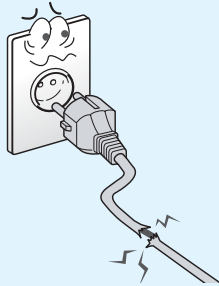

Never touch the power plug or outlet with wet hands.
- This may cause electric shock.

Please avoid touching the panel at the rear of LCD TV as it is producing high temperature.
- Direct contact with the hot surface may cause physical burns.

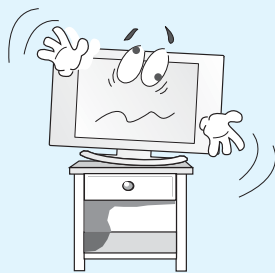

Do not install on an unstable place or small support.
- This may cause the LCD TV to fall, resulting in serious injury to a child or adult.

Do not use or store a flammable spray or inflammable things near the LCD TV.
- They may cause explosion or fire.

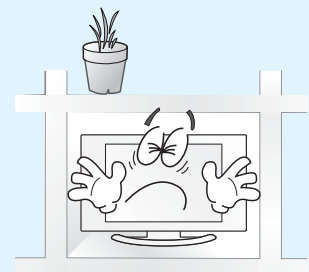

Do not install the LCD TV in a bookshelf, closet, or a place where there is poor air circulation.
- Fire may be caused due to the rise of internal temperature.



Safety PrecautionContinued from previous page

The contents of this section are provided for the safety of users and their property. Please read the instructions carefully before using.

WARNING

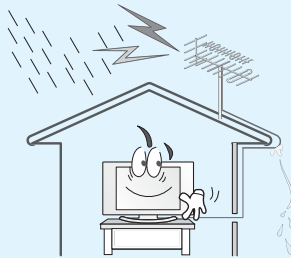

Make the antenna cable loop at the entrance of the building. Any necessary action such as making the antenna cable loop at the entrance of the building should be taken to prevent rainwater on the outdoor antenna cable from possibly running into the indoor.

- If raindrop gets into the LCD TV, it may cause a fire or an electric shock.

Never attempt to open, fix, or modify the LCD TV.

- When there is a need for fixing, call a service center. Fire or electric shock may be caused.



WARNING



Do not place any heat sources such as radiators and heat registers, etc. on or near the LCD TV.



- It may cause a fire.

Do not block ventilating slits.

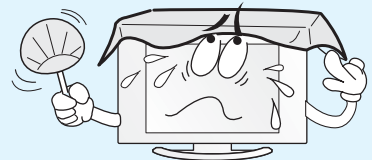
- Blocking the ventilation slits prevents inner heat from escaping, which may lead to a fire.



Safety instructions are divided into “Warning” and “Alert”. Their meanings are as follows.

-  This icon is intended to alert the user to the presence of potential danger and important operating instructions.
-  **Warning** : When there is a possibility of serious injury or death if not observed.
-  **Alert** : When there is a possibility of slight injury or product damage if not observed.



Do not put a metallic object like chopstick, wire, or puncher or inflammables like paper or a match in a vent, headphone jack, or AV jacks of the LCD TV.
- Electric shock or fire may be caused.

When the LCD TV produces abnormal noise, burning smell, or smoke, unplug the LCD TV immediately and call a service center.
- Electric shock or fire may be caused.

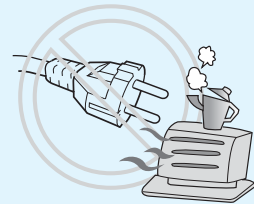

Ensure the power cord doesn't trail across any hot objects like a heater.
- This may cause a fire or an electric shock.

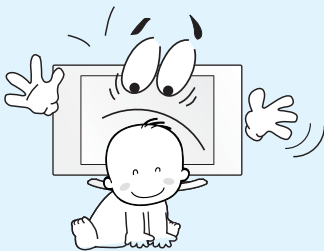

Do not install the product on the floor.
- If it falls over, your child may be injured.

Unplug the product during lightning or thunderstorms and never touch the antenna cable.
- It may cause a fire or an electric shock.

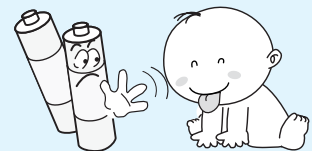
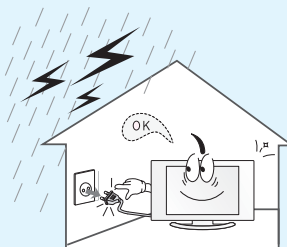

Keep the remote control batteries out of sight and out reach of children.
- If your child swallows a battery, see your doctor immediately.



Safety PrecautionContinued from previous page

The contents of this section are provided for the safety of users and their property.
Please read the instructions carefully before using.

WARNING

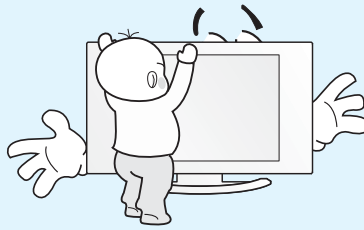

Do not allow children to climb or play on the LCD TV.
- If it falls over on children, it may cause serious injury.

Do not place toys and cookies, etc. on the LCD TV, which may attract children's attention. Children will climb on the LCD TV to reach whatever they have their eyes on.
- If it falls over on children, it may cause serious injury.

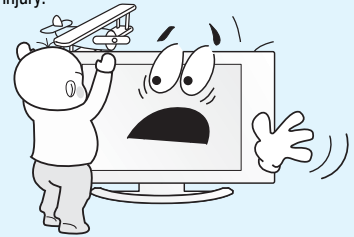

ALERT

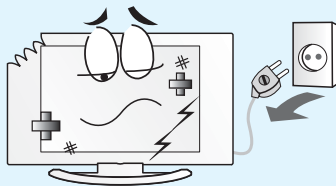



In the event of damaging or dropping the product, switch off the power and remove the plug.
- Using a damaged product may cause an electric shock or a fire.
- Contact your local service center.

Unplug when you do not use your LCD TV for a long time.

- If dust is stacked on the LCD TV, electric shock or fire may be caused from heat, fire, or deterioration of insulation.



Safety instructions are divided into “Warning” and “Alert”. Their meanings are as follows.

-  This icon is intended to alert the user to the presence of potential danger and important operating instructions.
-  **Warning** : When there is a possibility of serious injury or death if not observed.
-  **Alert** : When there is a possibility of slight injury or product damage if not observed.



When cleaning the LCD TV, make sure to disconnect the power plug and use a dry, soft cloth for a cleanup.

- Please avoid using chemicals such as wax, benzene, alcohol, thinner, mosquito spray, air freshener, lubricant or synthetic detergent.

When replacing batteries, make sure to match the batteries to the (+) and (-) marks in the battery compartment.

- Mismatching of polarities may result in internal damage to batteries, fire due to leakage or contamination.

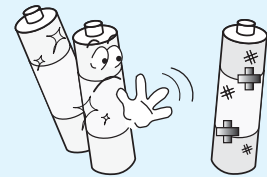
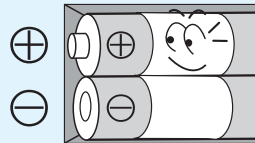

Always use the standard batteries and avoid using old batteries together with new ones.

- Otherwise it may result in internal damage to batteries, fire due to leakage or contamination.

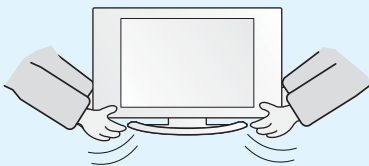

When moving the LCD TV, 2 or more people are advised to carry it.

- Injury or damage may be caused when the LCD TV falls.

Consult a service center or customer service for inside cleaning about once a year.

- When dust is piled inside the LCD TV for a long time, fire or malfunction may be caused.

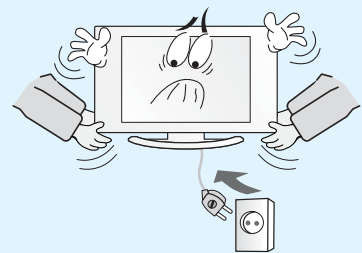

Before moving your LCD TV, ensure to switch off the power and unplug all the electrical cords and the external connection cords such as an antenna cable and other source connections, etc.

- An electrical cord(s) may be damaged resulting in a fire or an electrical shock.



Contents of the Package

To purchase additional parts, consult a distributor or selling agent.

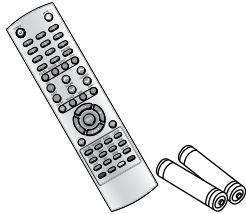

Remote Control/2
Batteries
(1.5V AAA)

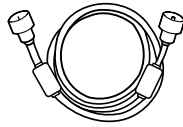

Antenna Cable

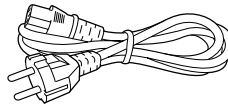

Power Cord

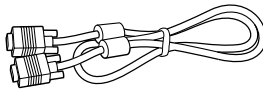

PC signal Cable(D-SUB)

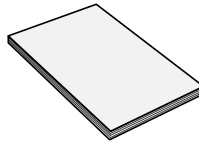

User's Guide

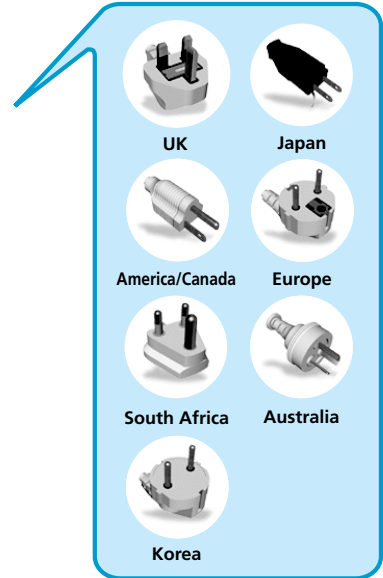

Separately Sold Products

If you want to purchase separately sold products, consult a service center, electronics shops, or parts seller.

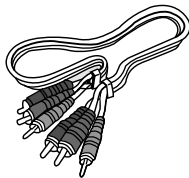

Component(Y, Pb, Pr) Cable

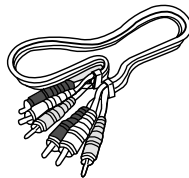

Composite(Video & Audio) Cable

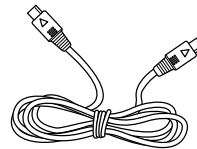

S-video cable

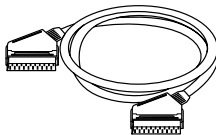

Scart Cable



Audio Cable(DVD/DTV)



Audio Cable(PC)

How to Use the Kensington Security Slot

- This display unit supports a Kensington-type security device to secure your LCD TV. Kensington lock is not included.
- To purchase and install the Kensington locking device, please refer to the following contact information.

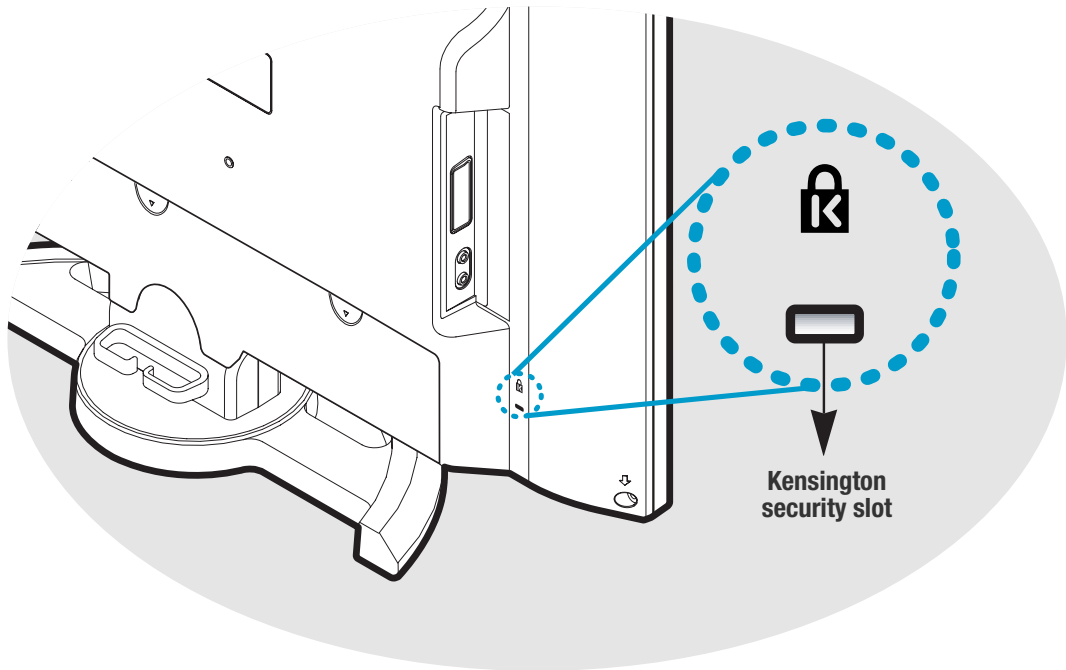

* Kensington Technology Group

- Address : 2000 Alameda de las Pulgas 2F San Mateo, California 94403-1289
- Tel : +1 650 572 2700 • Fax : +1 650 572 9675
- Web-site : www.kensington.com



How to Use the Rear Cap and Cable Holder

The Rear Cap and Cable Holder allow you to organize the connection cables on the rear of the product.

1. Pressing and pulling two hooks on the rear downward can detach the rear cover.
2. Connect your cables to the terminals of the rear.
3. Organize the connected cables neatly using the Cable Holder.
4. Align the rear cover with the guide holes and push the cover firmly toward the front of the monitor until the latches click into the locked position.

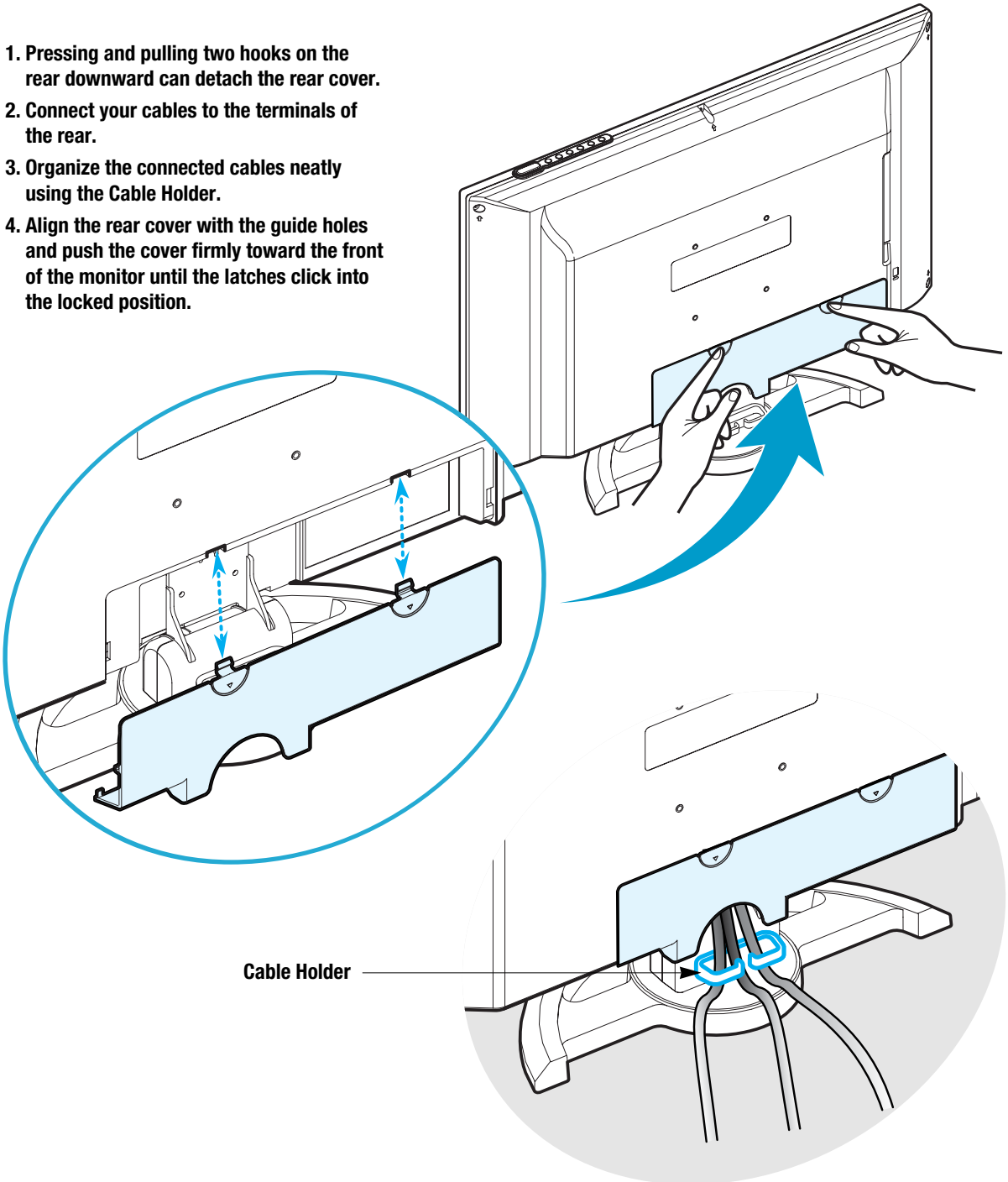

How to Adjust the View Angle

You can adjust the angle of the view for the desired view angle.

You can adjust any angle within a range of 30° to the left or right.

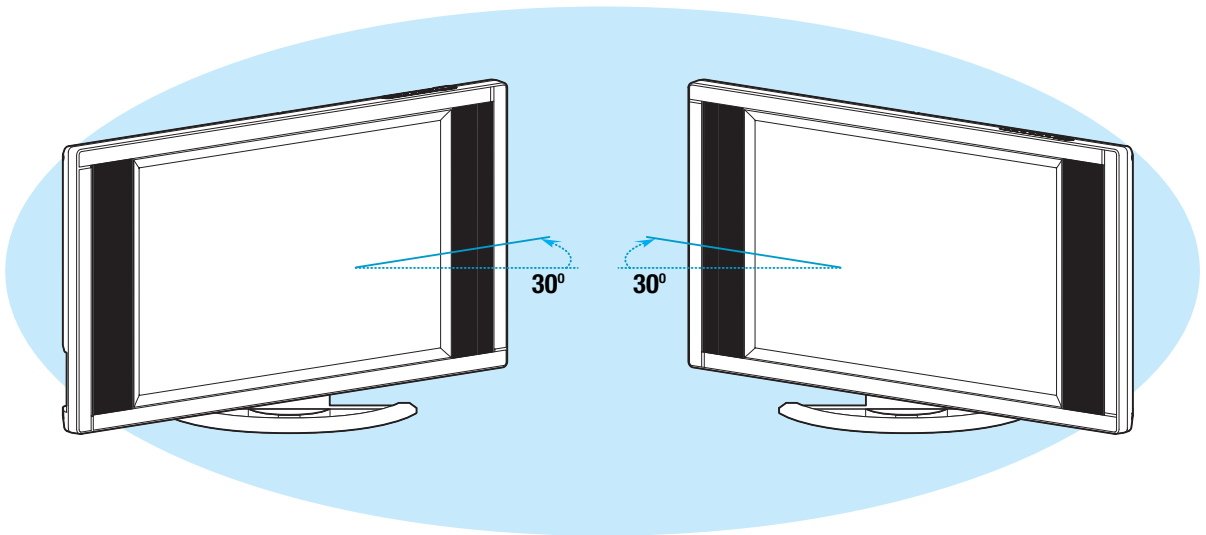

You can adjust the tilt of the TV from -5° to 10° after the installation.

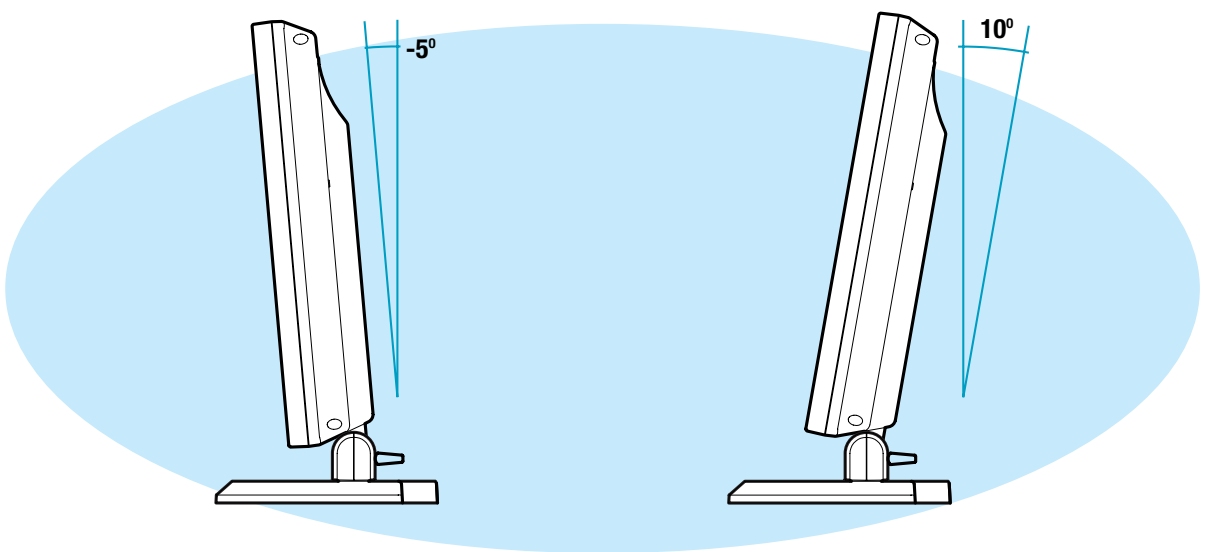



How To Install Wall Mount Support

1. Caution

1. Install on the vertical wall surface only.
2. Do not install on the following places to protect the performance of LCD TV and to prevent malfunction.
 - Near sprinkler Detector,
 - Near heating devices,
 - Places where vibration or shock may be applied ,
 - Near high voltage electric power line
3. Install in a proper method with the structural materials of the wall.
If the wall is not strong enough to stand weight of TV set, reinforce the wall surface before installation.
4. Do not install within a wall.

2. Parts configuration chart

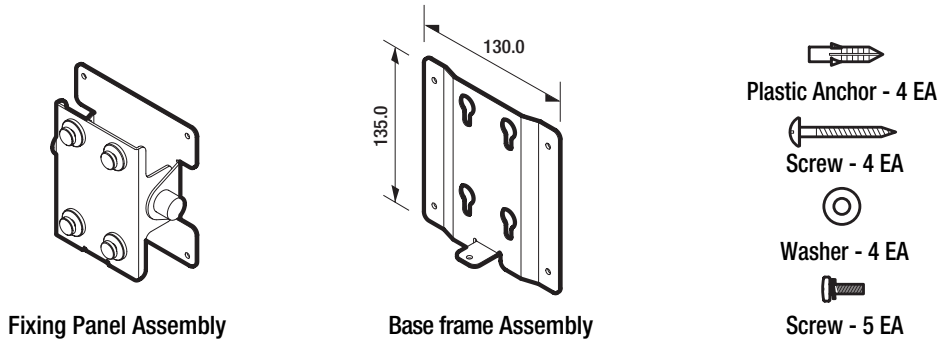

* The above image may look different from the real product.

3. Angle Adjustment(Optional)

The angle of LCD TV may be adjusted from -15 degree to 15 degree.

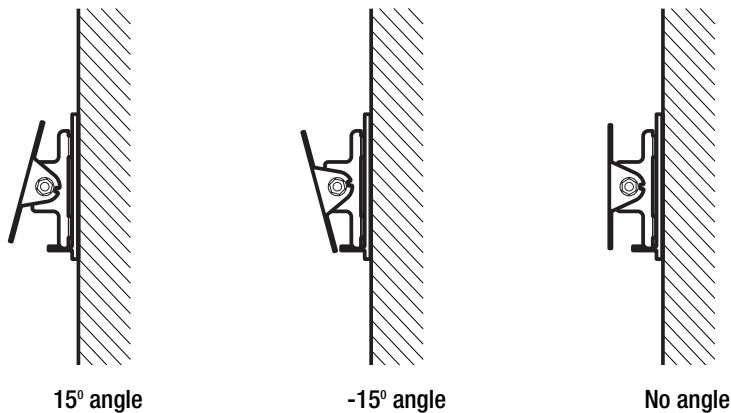

* A fixed wall mount frame does not support angle adjustment.

How To Install Wall Mount Frame

4. Installation Method

1. Unscrew screws fastened on 4 spots on the stand of LCD TV.

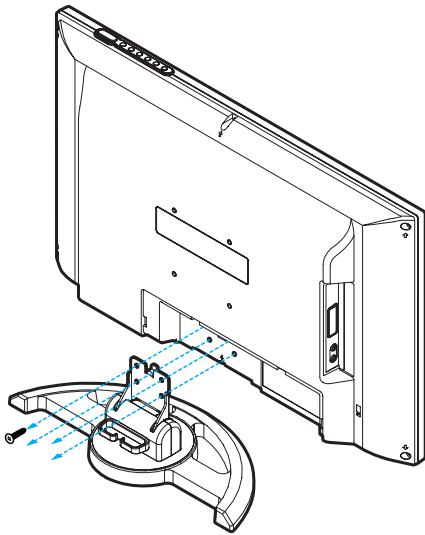

3. Fix the Base Frame Assy on the wall with screws or nails.

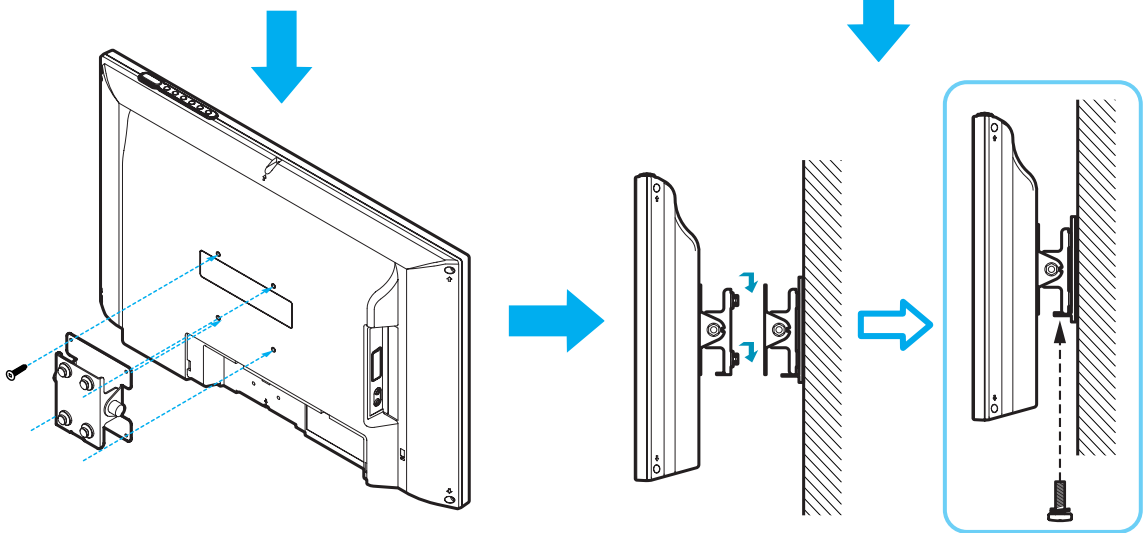
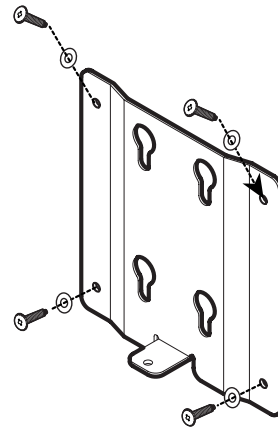

2. Fasten the Fixing Panel assembly on the back of LCD TV as shown on the picture.

(ATTENTION! Please use the supplied screws (4 x 12 mm or no longer than 12 mm.)

4. Hook the Fixing Panel Assy with the LCD TV attached on the Base Frame Assy. (Tighten the screws as shown in the above picture to ensure that the TV is secured.)



Parts Names and Functions

Front View

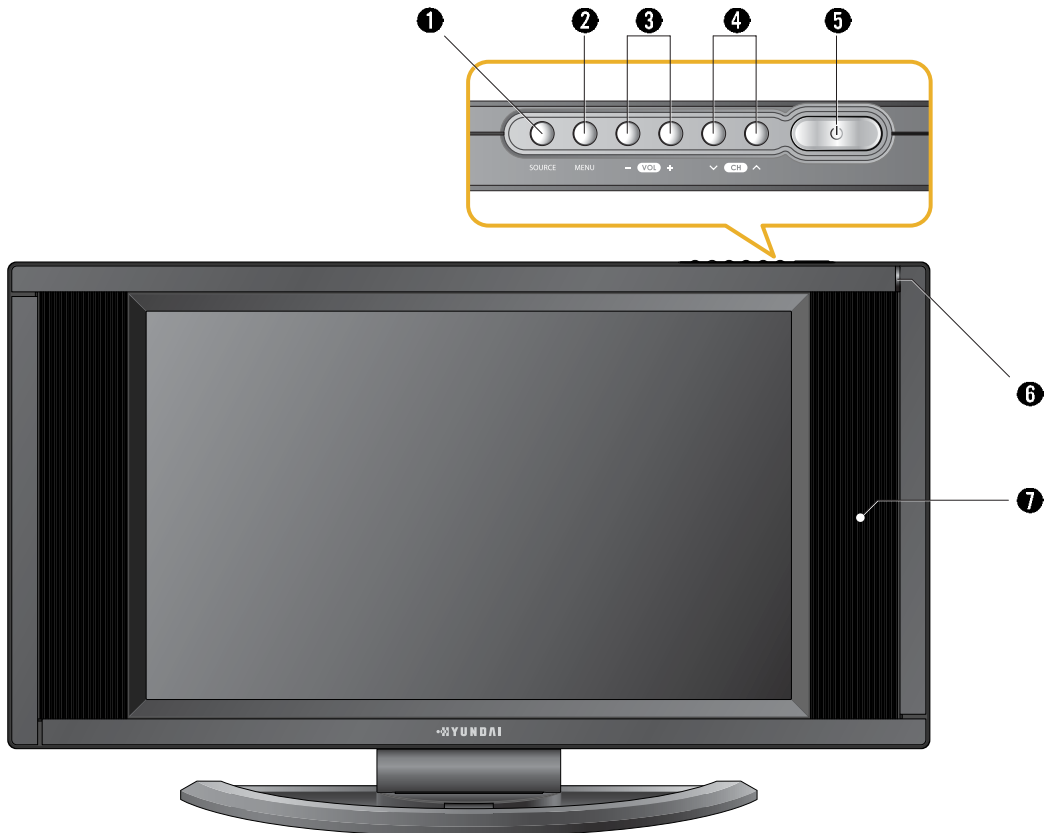

* The above image may look different from the real product.

❶ Source button

Use this button to switch among inputs connected to the LCD TV.

❷ Menu button

Use this button to display or exit from menus.

❸ Volume buttons

Use these buttons for your desired sound level. These buttons also serve as the cursor of Select/Adjust when in Menu mode.

❹ Channel(Program) buttons

Use these buttons to change programs. These buttons also serve as the cursor of Down and Up buttons when in Menu mode.

❺ Power button

Use this button to turn on or off the LCD TV.

❻ Remote sensor and power LED.

- Point the remote control toward here.
- It displays standby or operation status.

❼ Speaker

- Power Indicator Status -

Indicator	Status
Red	Stand-by
Green	Power on
Green blinking	Remote control

Rear View

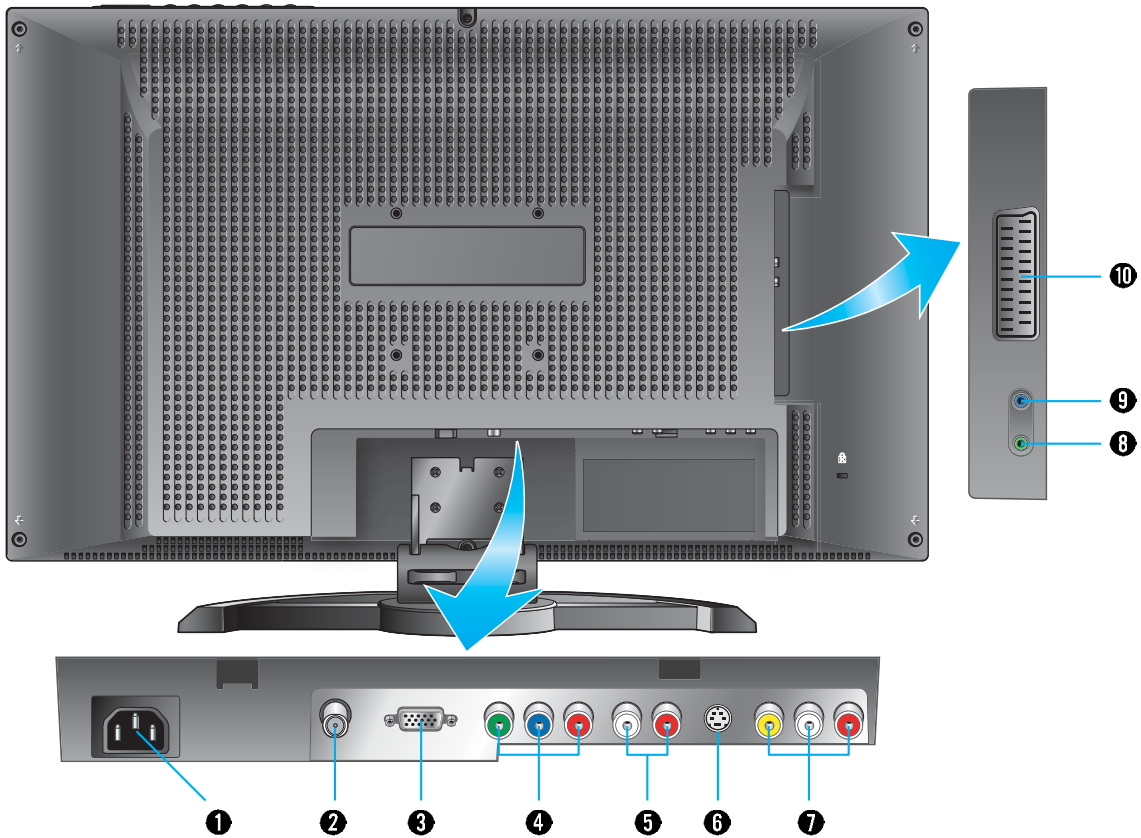

* The above image may look different from the real product.

- ❶ **Power input terminal**
Power cord is connected here.
- ❷ **ANT. input**
This allows you to connect your antenna.
- ❸ **D-SUB input terminal**
Connect to RGB output terminal of a PC.
- ❹ **Component input terminal for DVD or DTV**
Connect to the Component output terminal of DVD player/DTV receiver.
- ❺ **Audio input terminal for DVD or DTV**
Connect to the audio output terminal of DVD player/DTV receiver.
- ❻ **S-video input terminal**
Use this for the better video quality than Composite video input terminal.
- ❼ **Video and Audio Composite input terminal for VCR**
Connect to the Composite Video output terminal of VCR or DVD player.
- ❽ **Headphone Jack**
Connect to the Headphone.
- ❾ **Audio input Jack**
Connect to the audio output terminal of PC.
- ❿ **Scart input terminal**
For Composite Video/Audio or R, G, B input used in the European area.



Remote Control

1 POWER/STANDBY

Use this button to turn the TV set on or off.

2 MUTE

Use this button to turn the sound off completely.

3 NUMERIC KEYS

- Use these buttons to select programs and input digit.
- Enter program names using alphabets and special letters.

4 PRE-PR

Use these buttons to return to the previous program.

5 ASPECT RATIO

Use this button to change the picture size. (This function is available only with the TV, Video, S-Vedio, Scart mode.)

6 STILL

Use this button to freeze a picture.

7 VOLUME

Use this button to control the volume level.

8 PR

- Use this button to select programs.
- Use this button to jump back to TV mode from other mode.
- Use this button to turn the TV set on.

9 MULTI/S.SWAP

- Use this button to select 9 partitions screens. (This function is available only with the TV, Video, S-Video, Scart mode.)
- Sound Swap is only available when in PIP/POP mode.

10 SUB SOURCE

Use this button to select the input source in sub picture.

(⇒ TV ⇒ VIDEO ⇒ S-VIDEO ⇒ SCART ⇒)

11 UP/DOWN

Use these buttons to move each item of menu you want to choose.

12 MAIN SOURCE

- Use these buttons to display the available video source. (TV, VIDEO, S-VIDEO, SCART, COMPONENT, PC)

13 SLEEP

Use this button to allow your TV to turn off automatically at designated time.

14 INFO

Use this button to display input source and clock information.

15 S.MODE

Use this button to display types of audio signals currently aired on TV. Or you can use this button to switch to other Sound Mode available.

16 EXIT

- Use this button to exit from a menu or function.
- Use this button to exit from PIP/POP/MULTI.

17 LEFT/RIGHT

Use this button to select or adjust each item of menu.

18 MENU

Use this button to bring up the OSD on the screen.

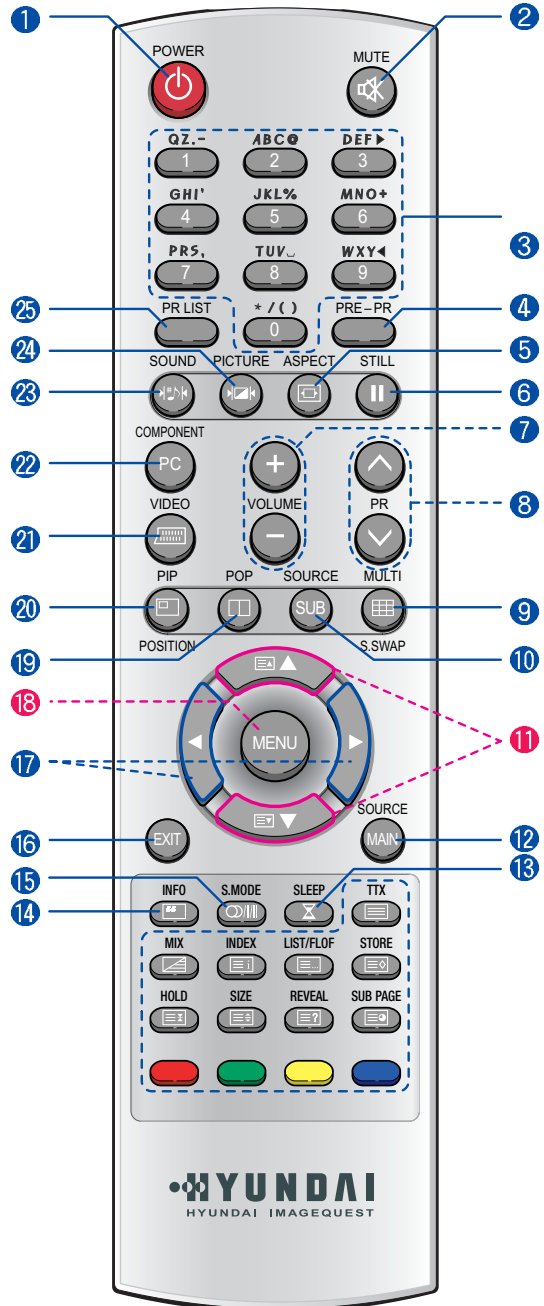

- ⑱ **POP (Picture Of Picture)**
Use this button for POP On/Off. (This function is available only with the TV, Video, S-Vedio, Scart mode.)
- ⑳ **PIP (Picture in Picture) / POSITION**
Use this button for PIP On/Off or select position.
- ㉑ **VIDEO**
Use this button to select Video, S-Video or Scart mode.
- ㉒ **COMPONENT/PC**
Use this button to select Component or PC mode.
- ㉓ **SOUND**
Use this button to select the status of sound.
- ㉔ **PICTURE**
Use this button to select the status of picture.
- ㉕ **PR LIST**
Use this button to select program list.

Teletext & Fastext Function —

(➔ P. 71 ~ 73)

- ① **TTX**
Use this button to activate the teletext mode.
- ② **LIST/FLOF**
To select LIST/FLOF mode.
- ③ **STORE**
To store teletext pages.
- ④ **SUB PAGE**
To move to Sub Page.
- ⑤ **REVEAL**
To reveal the hidden TTX information.
- ⑥ **BLUE**
To move between BLOCK and BLOCK.
- ⑦ **YELLOW**
To move to NEXT GROUP PAGE.
- ⑧ **GREEN**
To move to NEXT EXISTING PAGE.
- ⑨ **RED**
To return to the previous selection
- ⑩ **SIZE**
The size is changed from Normal, Double to Double Bottom mode in order.
- ⑪ **HOLD**
To freeze the TV screen when in Multi Page.
- ⑫ **MIX**
To select MIX mode.
- ⑬ **INDEX**
To move to INDEX in FLOF or move to INFO in TOP.

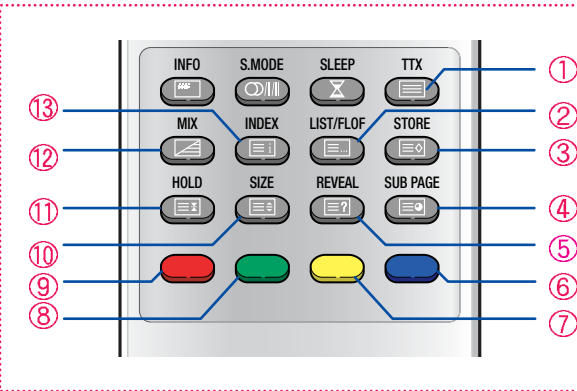

How to Insert Batteries in Remote Control

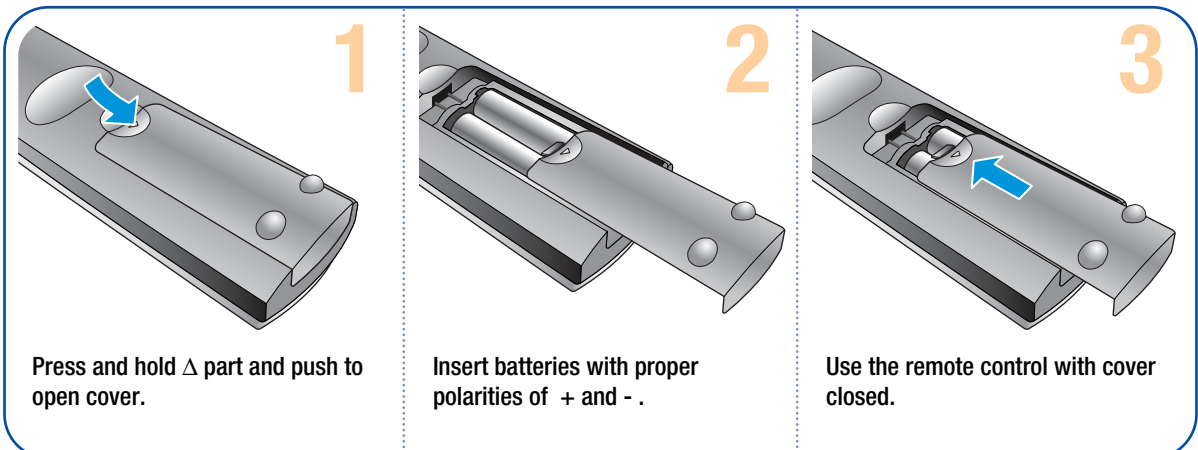

*Battery type : 1.5V/BP-2KM(AAA/LR03G)



Connections



Connecting Indoor/Outdoor TV Antenna(UHF/VHF)	23
Connecting to the Antenna Input Connection on the External Equipment	24
Connecting a VCR, Cable/Satellite Receiver	25
Connecting a DTV Receiver or DVD Player	26
Playing Back a Tape Recorded On a Camcorder	27
Connecting to a PC	28
Resolutions Supported in PC	29
Scart Connection to the External Input/Output	30
Scart Pin Specifications	31



Connecting Indoor/Outdoor TV Antenna(UHF/VHF)

Connection Method

Ensure to connect an antenna cable to the antenna input connection.

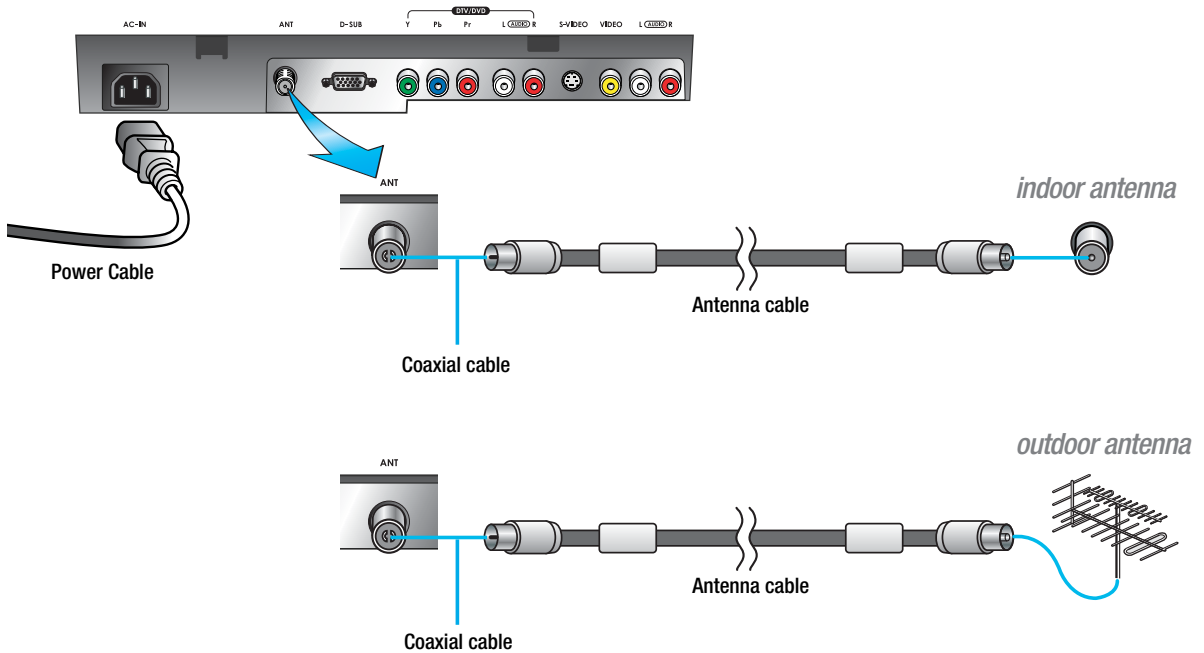

How to Watch

- 1 Turn on your LCD TV and press **SOURCE** **MAIN** or **PR** on remote control unit to select TV.

You can select ⇄ TV ⇄ VIDEO ⇄ S-VIDEO ⇄ SCART ⇄ COMPONENT ⇄ PC ⇄ in order.

- 2 Press **PR** or Numeric keys to select the desired Programs.

TIP

- When inserting a 75-ohm coaxial cable into the input connection, ensure the wire tip not to bend.
- If you experience poor signal reception, we recommend you purchase a signal amplifier for better picture quality.

Connecting to the Antenna Input Connection on the External Equipment

Connection Method

- 1 Connect an antenna cable to VCR/Cable/Satellite Receiver with the antenna input.
- 2 Use a coaxial cable to connect VCR/Cable/Satellite Receiver's antenna output to the antenna input on your LCD TV.

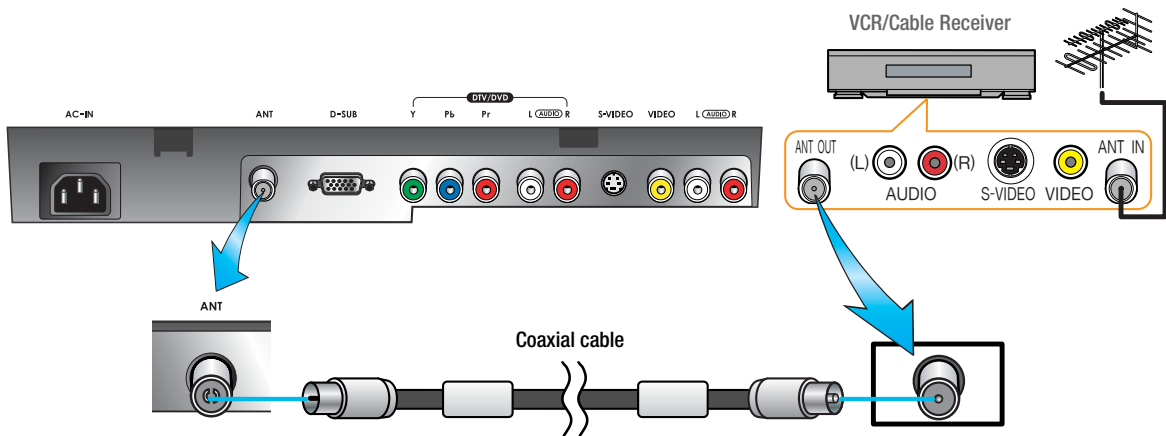



Connecting a VCR, Cable/Satellite Receiver

Connection Method

- 1 Connect Video/S-Video cable between Video/S-Video output terminal of VCR or Cable/Satellite receiver and Video/S-Video input terminal of LCD TV.
(Connect cables and terminal in the same colors)
- 2 Connect Audio cable (left:white color, right:red color) between Audio output terminal of VCR or cable/satellite receiver and Audio input terminal of LCD TV.
(Connect cables and terminal in the same colors)

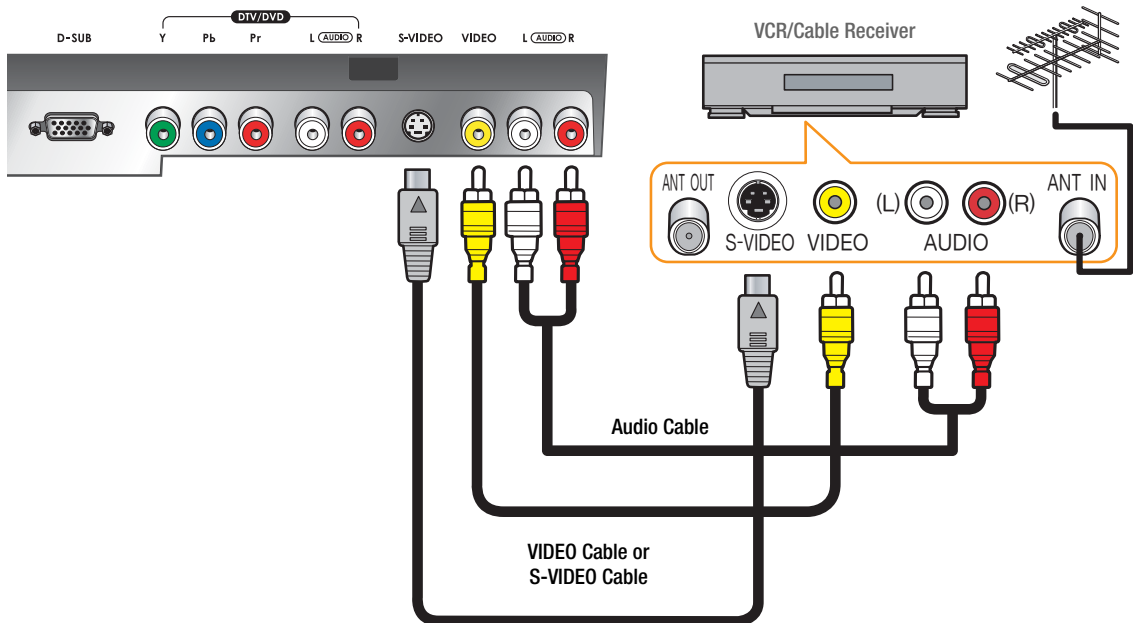

How to Watch

- 1 Turn on your LCD TV and press  on remote control unit to select Video or S-Video.
You can select ⇄ VIDEO ⇄ S-VIDEO ⇄ SCART ⇄ in order.
- 2 VCR play : Turn on the VCR and insert a tape and play it.
Cable/Satellite receiver : Turn on the receiver and select a channel.
Read a user manual of VCR, Cable/Satellite Receiver for more details.



Use S-video cables for better picture quality.

Connecting a DTV Receiver or DVD Player

Connection Method

- 1 Connect video cables(Y, Pb, Pr) between output terminals(Y, Pb, Pr) of DTV receiver or DVD player and the input terminals(Y, Pb, Pr) of DTV/DVD on the rear of LCD TV.
(Connect cables and terminal in the same colors)
- 2 Connect Audio cable between Audio output terminal of DTV receiver or DVD player and Audio input terminal for DTV/DVD Audio on the rear of LCD TV.
(Connect cables and terminal in the same colors)

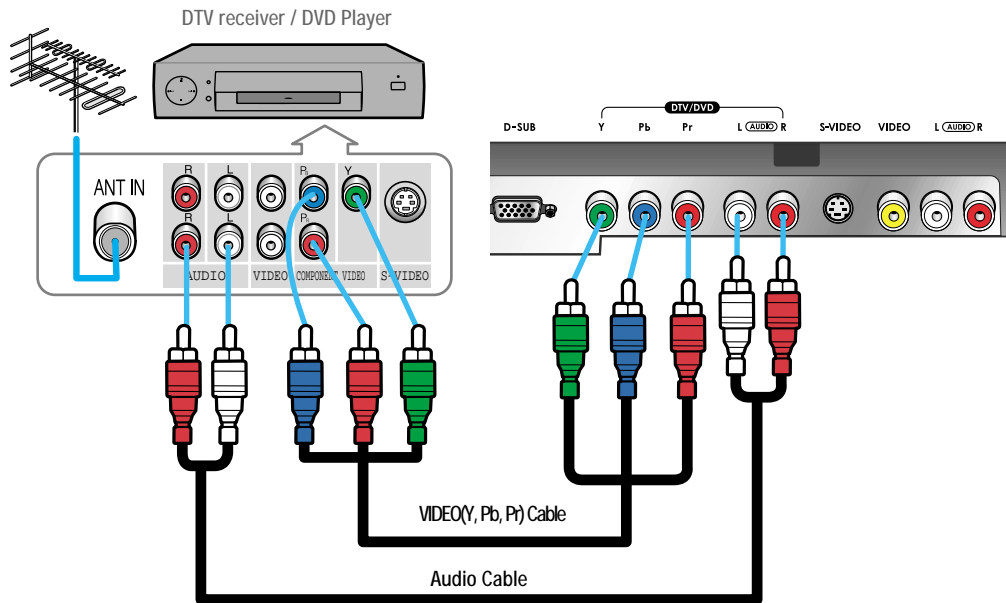

How to Watch

- 1 Turn on your LCD TV and press **COMPONENT PC** on remote control unit to select DTV or DVD.
You can select ⇄ COMPONENT ⇄ PC ⇄ in order.
- 2 Turn on a DTV receiver or DVD player and use it.
Read the user manual of DTV receiver or DVD player for more details.

TIP

- Output terminal mark(Y, Pb, and Pr) of DVD player may be written as Y, B-Y, R-Y/Y-Cb-Cr / Y-Pb-Pr. (It depends on DVD player)
- To watch digital broadcast, you have to separately purchase a digital set-top box and connect it to LCD TV.



Playing Back a Tape Recorded On a Camcorder

Connection Method

- 1 Connect Video cable between Video output terminal of Camcorder/Game player and Video input terminal of LCD TV.
(Connect cables and terminal in the same colors)
- 2 Connect Audio cable (left:white color, right:red color) between Audio output terminal of Camcorder/Game player and Audio input terminal of LCD TV.
(Connect cables and terminal in the same colors)

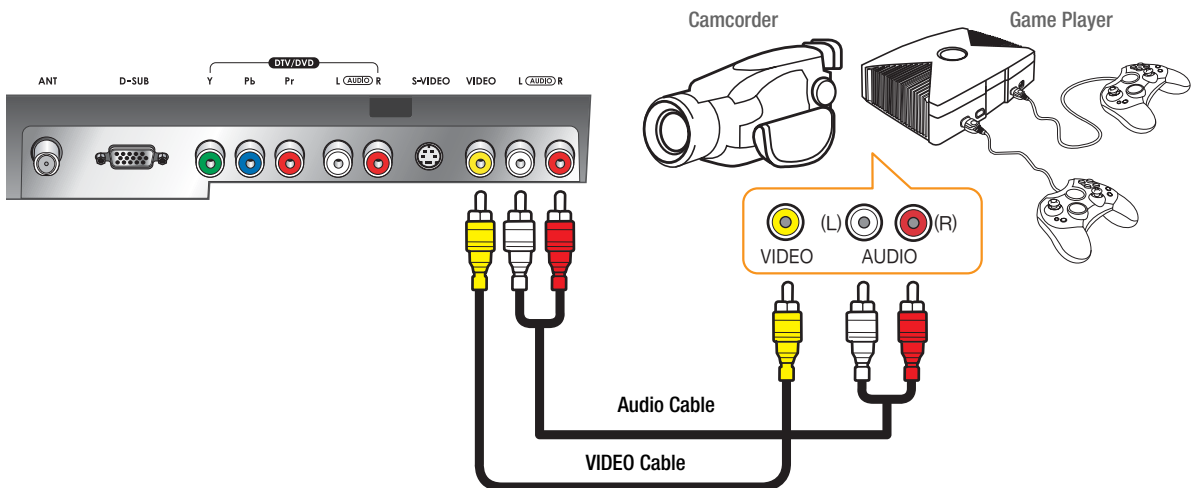

How to Watch

- 1 Turn on your LCD TV and press  on remote control unit to select Video.
You can select ⇄ VIDEO ⇄ S-VIDEO ⇄ SCART ⇄ in order.
- 2 Turn on a Game player or Camcorder and use it.
Read the user manual of Game player or Camcorder for more details.

Connecting to a PC

Connection Method

- 1** Connect PC signal cable(15 pins D-SUB) between output terminal of PC and the D-SUB input terminal of a LCD TV.
- 2** Connect Audio cable between Audio output terminal of PC and Audio input terminal for PC of LCD TV. (Connect cables and terminal in the same colors)

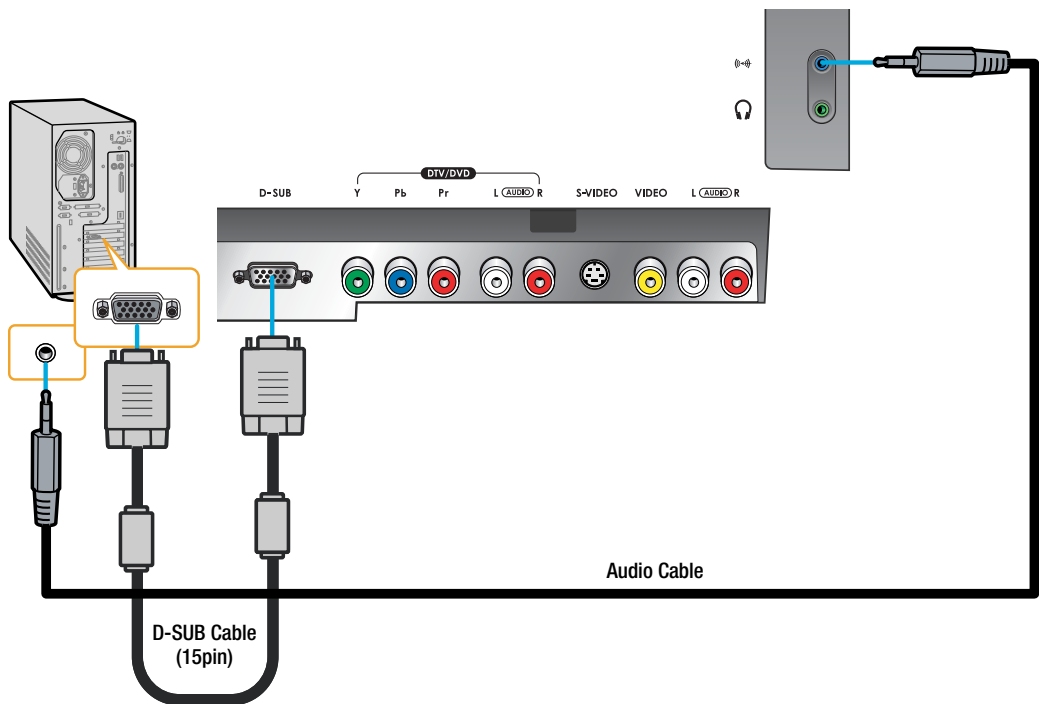

When Using as a PC Monitor

- 1** Turn on your LCD TV and press **COMPONENT**  on remote control unit to select PC.
You can select ⇄ COMPONENT ⇄ PC ⇄ in order.
- 2** Turn on the PC and use it. (Refer to next page on the back for the supported resolutions for PC)



This product supports plug-and-play function.



Resolutions Supported in PC

Resolution	Horizontal frequency(kHz)	Vertical frequency(Hz)
720 x 400	31.5	70.1
640 x 480	31.5	59.9
	37.9	72.8
800 x 600	37.9	60.3
	46.9	75
1024 x 768	48.4	60
	56.5	70.1
	60	75

HQL200NR

- Recommended Resolution is 640x480@60Hz
- Max Resolution is 1024x768@75Hz

HQL170WR

- Recommended Resolution is 1024x768@60Hz
- Max Resolution is 1024x768@75Hz

Scart Connection to the External Input/Output

Connection Method

This end can be fitted with : A Scart connector

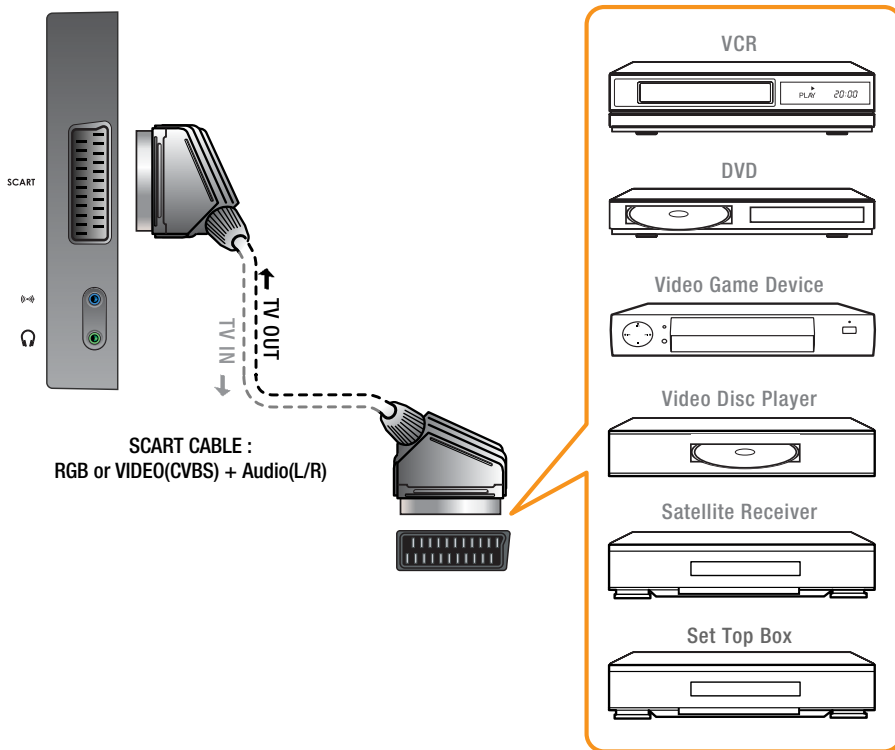

How to Watch

1 Turn on your LCD TV and press  on remote control unit to select SCART.

You can select ⇄ VIDEO ⇄ S-VIDEO ⇄ SCART ⇄ in order.

2 Read a user manual of VCR, DVD, Satellite Receiver and other etc. for more details.

TIP

- When switching voltage comes into the Scart-Pin 8 during viewing a TV program, the current mode will be switched to Scart mode.
- Any inappropriate connection when connecting or removing your scart connector may generate a Blue Screen. If this happens, ensure that the scart connector is properly connected.



Scart Pin Specifications

If you wish to connect other equipment via the scart connectors on your TV, contact your dealer or a qualified technician to wire the A/V cable as illustrated below.

PIN	SIGNAL	PIN	SIGNAL
1	Audio Output R	12	-
2	Audio Input R	13	Red Input GND
3	Audio Output L	14	-
4	Audio Input GND	15	RGB Red Input
5	Blue Input GND	16	RGB Blinking Signal Input
6	Audio Input L	17	Video Output GND
7	RGB Blue Input	18	Video Input GND
8	Switching Voltage Input	19	Video Output (CVBS)
9	Green Input GND	20	Video Input (CVBS)
10	-	21	Scart Connector GND
11	RGB Green Input		

Picture Setup



How to Select the Picture Mode	33
How to Set the Desired Picture	34
How to Set Noise Reduction	35
How to Set PIP [Mode]	36
How to Set POP [Mode]	36
How to Set Multi [Mode]	37
How to Freeze Picture	38
How to Select the Aspect Ratio	39



How to Select the Picture Mode

Users can adjust picture mode automatically according to the input mode(TV, Video, S-Video, Scart, Component).



Press Menu button.
Menu items appear on the screen.

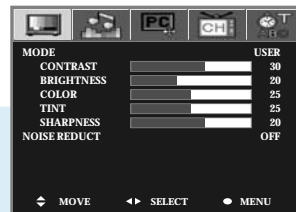

1



Press Left and Right buttons to select
“”.

2



Press Up and Down buttons to move to
“Mode”.

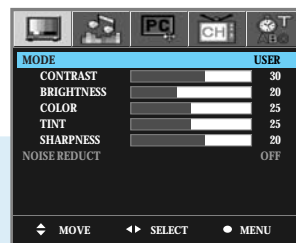

3



Press Left and Right buttons, then the menu
changes in order below.
⇒ STANDARD ⇒ USER ⇒ DYNAMIC ⇒ MILD ⇒



Press MENU button after the setting is done, and Menu goes to the previous menu.
If the EXIT button is pressed, the menu disappears.

STANDARD : For a general contents, It fits most video contents.

USER : When the user wants to set the values ➔ [see the next page](#)

DYNAMIC : For a clear display.

MILD : For a soft display.

PICTURE

How To Directly Select Picture Mode : Press  button.

- Users can select ⇒ Standard ⇒ User ⇒ Dynamic ⇒ Mild ⇒ in order.

TIP

Adjustments menu may be different according to the input source.
(To set Picture mode in PC mode, please see page 51.)

How to Set the Desired Picture

Users can manually adjust the picture in their own ways.

- 

Press Menu button.
Menu items appear on the screen.
- 1**



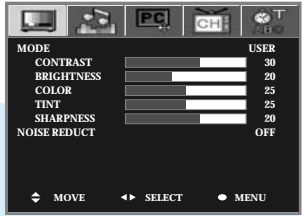

Press Left and Right buttons to select "MODE".

- 2**

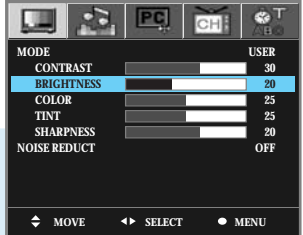

Press Up and Down buttons to move to "MODE".



- 3**



Press Left and Right buttons to select "USER".
- 4**



Press Up and Down buttons to choose one of the items listed.
- 5**



Press Left and Right buttons to adjust.
- 

Press MENU button after the setting is done, and Menu goes to the previous menu.
If the EXIT button is pressed, the menu disappears.

CONTRAST : Adjust the brightness and darkness of object and background.
BRIGHTNESS : Adjust the brightness of the entire picture.
COLOR : Adjust colors into deeper or lighter colors.
TINT : Adjust colors naturally.
SHARPNESS : Adjust clarity of outline of objects.



- COLOR, TINT, SHARPNESS is not applied to PC mode.
- SHARPNESS is not applied to Component mode.



How to Set Noise Reduction

Noise Reduction is to eliminate some noise on the screen and is not applied to Component and PC mode.



Press **Menu** button.
Menu items appear on the screen.

1



Press **Left** and **Right** buttons to select
“”.

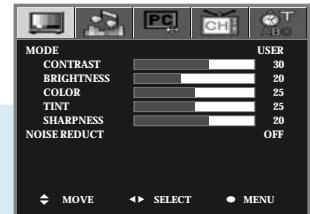

2



Press **Up** and **Down** buttons to move to
“**NOISE REDUCT**”.

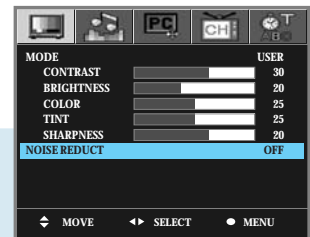

3



Press **Left** and **Right** buttons, then the menu
changes in order below.
⇒ **OFF** ⇒ **MIDDLE** ⇒ **STRONG** ⇒



Press **MENU** button after the setting is done, and Menu goes to the **previous** menu.
If the **EXIT** button is pressed, the menu **disappears**.

OFF : For a normal screen.

MIDDLE : For a reduced noise on the screen.

STRONG : For a strongly reduced noise on the screen.

TIP

In the noise reduction, the more you reduce screen noise, the more the sharpness level of the picture will degrade.

How to Set PIP [Mode]

- You can watch another device's image in the PIP while watching the main image.
- This function is available only with the remote control.



Press the PIP button.
You will see the PIP at the upper left corner.



Press the PIP button, then position changes in order below.
 ⇨ Left Up ⇨ Right Up ⇨ Right Down
 ⇨ Left Down ⇨ OFF ⇨

SOURCE



Press the SOURCE button, then PIP input source changes in order below.
 ⇨ TV ⇨ VIDEO ⇨ S-VIDEO ⇨ SCART ⇨

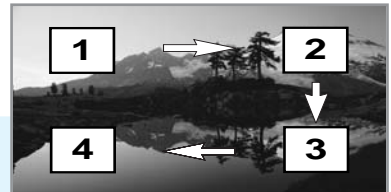

To deselect PIP function, Press EXIT button.

How to Set POP [Mode]

- You can watch another device's image in the POP while watching the main image in TV, VIDEO, S-VIDEO or SCART mode.
- This function is available only with the remote control.



Press the POP button.
You will see the POP at the Right.
To deselect POP function, Press POP button once more.

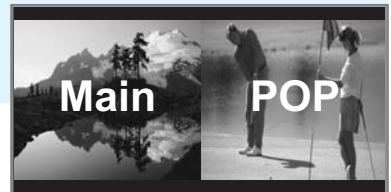

SOURCE



Press the SOURCE button, then POP input source changes in order below.
 ⇨ TV ⇨ VIDEO ⇨ S-VIDEO ⇨ SCART ⇨



To deselect POP function, Press EXIT button.

TIP

- Main and sub pictures cannot have the same input source.
- In case of TV mode, you can change the PIP TV program by "PR" Button.
- In case of TV mode, you can change the POP TV program by "PR" Button.



How to Set Multi [Mode]

- You can watch all 9 screens in sequence.
- You can watch another device's image in the MULTI while watching the main image in TV, VIDEO, S-VIDEO or SCART mode.
- This function is available only with the remote control.

MULTI



S.SWAP



Press the MULTI button.
 You will see the Multi screen of nine screens.
 To deselect Multi function, Press Multi button once more.

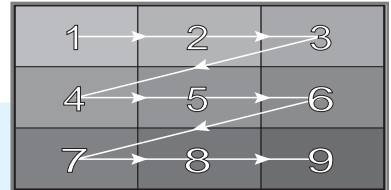

To deselect Multi function,
Press EXIT button.



- In case of TV mode, you can change the multi TV program.
- You cannot change the multi input source.
- This function is not available when in PIP/POP Mode.

Supported PIP Table

PIP : 0 → Supported, X → Not Supported

Sub \ Main	TV	Video	S-Video	Scart	Component	PC
TV	X	0	0	0	0	0
Video	0	X	0	0	0	0
S-Video	0	0	X	0	0	0
Scart	0	0	0	X	0	0
Component	X	X	X	X	X	X
PC	X	X	X	X	X	X

Supported POP Table

POP : 0 → Supported, X → Supported

Sub \ Main	TV	Video	S-Video	Scart	Component	PC
TV	X	0	0	0	X	X
Video	0	X	0	0	X	X
S-Video	0	0	X	0	X	X
Scart	0	0	0	X	X	X
Component	X	X	X	X	X	X
PC	X	X	X	X	X	X



- When power is ON/OFF, PIP, POP and MULTI functions are not stored.
- When main picture is in PC/Component input mode, POP function is not supported.
- In PIP or POP function, you cannot use PC/Component input mode for sub-picture.
- In PC/Component input mode, MULTI function is not supported.
- While MULTI function is activated, STILL is not supported.
- While PIP is activated, you cannot change the sub-picture's size.
- Image SWAP function is not supported.

How to Freeze Picture

The user can temporarily stop the playing picture.

STILL



Press Still button.

Playing picture is stopped.

** In PIP/POP mode, the main picture stops.*

To deselect Still function.

Press Still button once more.



How to Select the Aspect Ratio

- Users can adjust Aspect Ratio as users want.
- This function is available only with the remote control.

ASPECT



Press the ASPECT button, then Aspect Ratio changes in order below.

⇒ NORMAL ⇒ Zoom ⇒ 16:9 ⇒ (HQL200NR)

⇒ NORMAL ⇒ Panorama ⇒ Zoom ⇒ 4:3 ⇒ (HQL170WR)

PICTURE SETUP

Normal

General broadcast picture size.



Normal

General broadcast picture is adjusted to 15:9.

16:9

General broadcast picture is adjusted to 16:9.

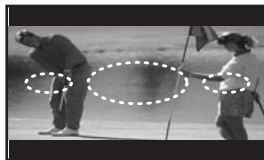

Panorama

Picture size for panorama video.

Zoom

Zoom in 4:3 in vertical direction. (This mode is recommended in letter box format.)

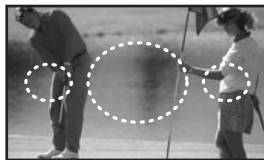

Zoom

Zoom in 4:3 in vertical direction. (This mode is recommended in letter box format.)

4:3

General broadcast picture size.



This function is available only in TV, VIDEO, S-VIDEO, SCART mode. This function is not available in PIP, POP, MULTI mode.

Audio Setup



How to Select the Volume, Balance and Mute	41
How to Set the Audio Mode(Equalize)	42
How to Set the Desired Audio	43
How to Listen to Stereo Sound / Dual Sound	44
How to Select the Surround	46
How to Select AVL	47
How to Select the Sound Swap	48



How to Select the Volume, Balance and Mute

- Users can adjust the volume and Balance of left and right speakers.



Press Menu button.
Menu items appear on the screen.

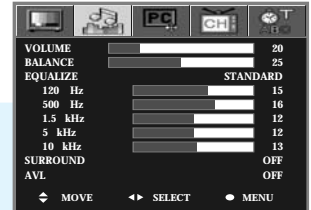

1



Press Left and Right buttons to select
“”.

2



Press Up and Down buttons to move to
“VOLUME or BALANCE”.

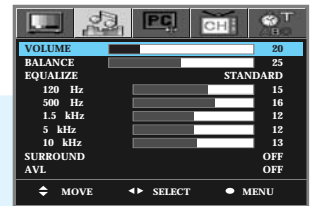

3



Press Left and Right buttons to adjust.



Press MENU button after the setting is done, and Menu goes to the previous menu.
If the EXIT button is pressed, the menu disappears.

MUTE

How To Select the Mute : Press  button.

Playing sound is Stopped.

To deselect Mute function, Press MUTE button once more.

How to Set the Audio Mode(Equalize)

Users can adjust sound mode automatically as users want.



Press Menu button.
Menu items appear on the screen.

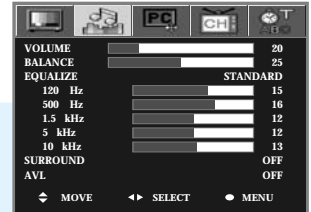

1



Press Left and Right buttons to select



2



Press Up and Down buttons to move to
"EQUALIZE".

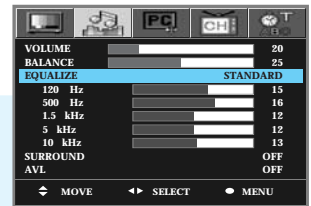

3



Press Left and Right buttons, then the menu
changes in order below.

⇒ STANDARD ⇒ MUSIC ⇒ MOVIE ⇒ NEWS ⇒ USER ⇒



Press MENU button after the setting is done, and Menu goes to the previous menu.
If the EXIT button is pressed, the menu disappears.

STANDARD : For the general sound. This fits most audio contents.

MUSIC : For original sound

MOVIE : For grandiose sound

NEWS : For clear sound

USER : When the user wants to set the value ➔ [see the next page](#)

SOUND

How To Directly Select Sound Mode : Press  button.

Users can select ⇒ STANDARD ⇒ MUSIC ⇒ MOVIE ⇒ NEWS ⇒ USER ⇒ in order.



How to Set the Desired Audio

Users can manually adjust the sound in their own ways.



Press **Menu** button.
Menu items appear on the screen.



1



Press **Left** and **Right** buttons to select
“”.

2



Press **Up** and **Down** buttons to move to
“**EQUALIZE**”.

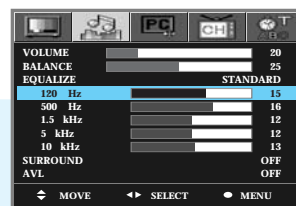

3



Press **Left** and **Right** buttons to select “**USER**”.

4



Press **Up** and **Down** buttons to choose one of the items listed.
⇒ 120 Hz ⇒ 500 Hz ⇒ 1.5 kHz ⇒ 5 kHz ⇒ 10 kHz ⇒

5



Press **Left** and **Right** buttons to adjust.



Press **MENU** button after the setting is done, and Menu goes to the **previous menu**.
If the **EXIT** button is pressed, the menu **disappears**.



How to Listen to Stereo Sound / Dual Sound

- Users can set sound mode as users want.
- This function is available only with the remote control.

- Listening to stereo sound

S.MODE



Press the  button on the remote control to select Mono or Stereo. Mono or Stereo be will selected in turn whenever you press the button.
 (*During FM MONO broadcast, pressing the  button will display the current status.)

- Listening to the Dual sound

S.MODE



Press the  button on the remote control to select Dual sound.

Dual 1 : Your national language.

Dual 2 : Foreign language

(*Dual 1 or Dual 2 be will selected in turn whenever you press the button.)



This S.MODE displays the current Audio signal status, and controls the processing of Audio signal. When power is switched on, the mode is automatically preset to either “Dual-I” or “Stereo”, depending on the current signal transmission condition.

	Type of Broadcast	On-Screen Indication
NICAM Stereo	Regular Broadcast (Standard audio)	Mono (Normal use)
	Regular+ NICAM Mono	NICAM Mono ↔ Mono
	NICAM Stereo	NICAM Stereo ↔ Mono
	NICAM Dual-I/II	NICAM Dual 1 ↔ NICAM Dual 2 ↔ Mono ↔
A2 Stereo	Regular broadcast (Standard audio)	Mono (Normal use)
	Bilingual or Dual-I/II	Dual 1 ↔ Dual 2
	Stereo	Stereo ↔ Mono

TIP

If the signal reception conditions deteriorate, setting to Mono will make your listening condition better.

How to Select the Surround

You can listen to dynamic and surround sound only with ordinary speakers.



Press **Menu** button.
Menu items appear on the screen.

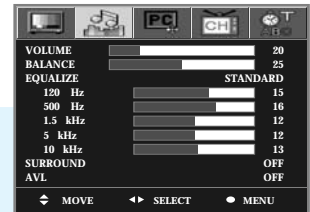

1



Press **Left** and **Right** buttons to select
“”.

2



Press **Up** and **Down** buttons to move to
“**SURROUND**”.



3



Press **Left** and **Right** buttons to select “**ON/OFF**”.



Press **MENU** button after the setting is done, and Menu goes to the **previous menu**.
If the **EXIT** button is pressed, the menu **disappears**.



How to Select AVL

This function automatically gives a similar volume size to each channel.



Press **Menu** button.
Menu items appear on the screen.

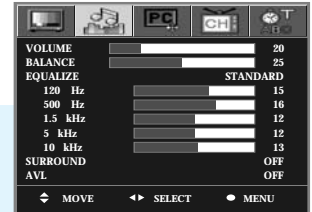

1



Press **Left** and **Right** buttons to select
“”.

2



Press **Up** and **Down** buttons to move to
“**AVL**”.



3



Press **Left** and **Right** buttons to select “**ON/OFF**”.



Press **MENU** button after the setting is done, and Menu goes to the **previous menu**.
If the **EXIT** button is pressed, the menu **disappears**.

How to Select the Sound Swap



Press the  button.

The Main Sound and Sub Sound will switch with each other whenever you press this button.

TIP

- An Audio Swap function is only available when in PIP/POP mode.
- A Multi function is not available when in PIP/POP mode.
- If you select the Audio Swap in Audio Swap mode and end PIP/POP, the sound of main screen will come back.
- The audio input jack is used for both Video and S-Video.
- While watching the main screen and listening to the sound of sub-screen, the sound of sub-screen will be still active even if you switch the current channel to another
- After selecting the Audio Swap, when you turn the power off and back on, the sound of main-screen will come back.
- After switching to the sound of sub-screen in PIP/POP mode, even if you change the input of sub-screen to other input, the sound of sub-screen will be still kept.



AUDIO SETUP

PC Setup



How to Select the Color Mode	51
How to Select the Auto Adjust	52
How to Set the Geometry	53



How to Select the Color Mode

This function is available only with the PC mode.



Press Menu button.
Menu items appear on the screen.

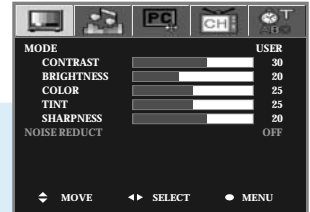

1



Press Left and Right buttons to select
“”.

2



Press Up and Down buttons to move to
“Mode”.

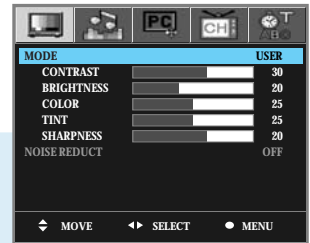

3



Press Left and Right buttons, then the menu
changes in order below.
⇒ STANDARD ⇒ USER ⇒ COOL ⇒ WARM ⇒



Press MENU button after the setting is done, and Menu goes to the previous menu.
If the EXIT button is pressed, the menu disappears.

STANDARD : Color for general picture.

USER : When the user wants to set the values → [see the 34 page](#)

COOL : For colors with bluish tone.

WARM : Warm colors with reddish tone.

PICTURE

How To Directly Select Picture Mode : Press  button.

- Users can select ⇒ Standard ⇒ User ⇒ Cool ⇒ Warm ⇒ when the input mode is PC mode.

How to Select the Auto Adjust

- Horizontal/Vertical positions are automatically adjusted.
- This function is available only with the PC mode.



Press **Menu** button.
Menu items appear on the screen.

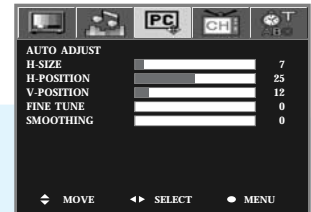

1



Press **Left** and **Right** buttons to select
“**PC**”.

2



Press **Up** and **Down** buttons to move to
“**Auto Adjust**”.

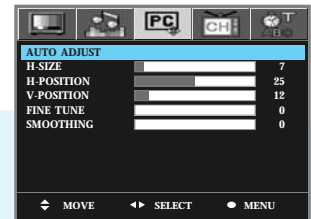

3



Press **Left** and **Right** buttons to “**Auto Adjust**”,
then it will be adjusted the screen.



Press **MENU** button after the setting is done, and Menu goes to the **previous menu**.
If the **EXIT** button is pressed, the **menu disappears**.



How to Set the Geometry

- This is to reduce image retention and noise.
- This function is available only with the PC mode.



Press **Menu** button.
Menu items appear on the screen.

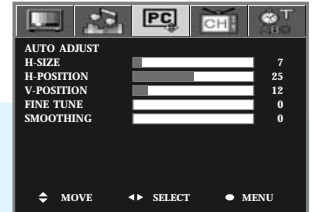

1



Press **Left** and **Right** buttons to select
“ **PC** ”.

2



Press **Up** and **Down** buttons to choose
one of the items listed.

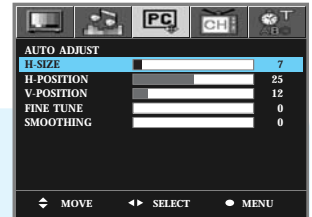

3



Press **Left** and **Right** buttons to adjust.



Press **MENU** button after the setting is done, and Menu goes to the **previous menu**.
If the **EXIT** button is pressed, the **menu disappears**.

- H-SIZE** : To adjust the horizontal size of the picture.
- H-POSITION** : To adjust the horizontal position of the picture.
- V-POSITION** : To adjust the vertical position of the picture.
- FINE TUNE** : To adjust to eliminate the shake of picture.
- SMOOTHING** : To change viewing point at high resolution(Upper VGA)

TV Setup



How to Store Program Automatically	55
How to Set Manual Store	56
How to Directly Select the PR LIST	59



How to Store Program Automatically

- When you start using your TV for the first time, you must select your country to auto store.
- You can scan channels available to you automatically.



Press **Menu** button.
Menu items appear on the screen.

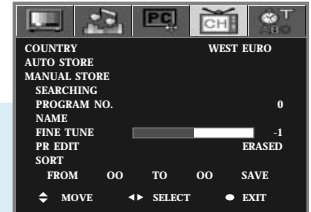

1



Press **Left** and **Right** buttons to select
“**CH**”.

2



Press **Up** and **Down** buttons to move to
“**Country**”.

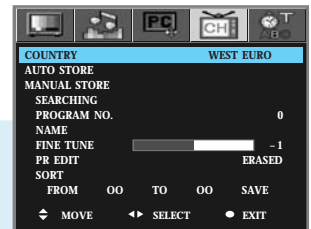

3



Press **Left** and **Right** buttons,
then the menu changes in order below.
⇒ WEST EURO ⇒ EAST EURO ⇒ FRANCE ⇒ UK ⇒ OTHERS ⇒

4



Press **Up** and **Down** buttons to move to
“**Auto Store**”.
Frequency : 48.25 Mhz ~ 855.25 Mhz

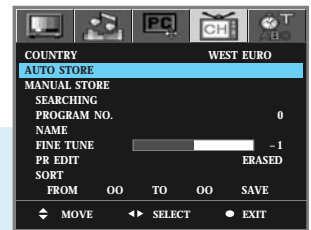

5



Press **Left** and **Right** buttons to select “**Auto Store**”,
then it will be stored the searched channels.
After completing channel searching,
it will return to the first stored program No.

6













Press **MENU** button after the setting is done, and Menu goes to the **previous menu**.
If the **EXIT** button is pressed, the menu disappears.

TIP

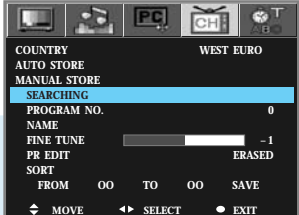
- When AUTO STORE is completed, you will get back to the first stored program No.
- If you press MENU or EXIT button during AUTO STORE in progress, the AUTO STORE will stop at the last stored program No. at the moment of pressing the button.
- After activating AUTO STORE, program numbers in green indicate that the correspondent channels are stored and program numbers in blue indicate that the correspondent channels are not stored.
- After activating AUTO STORE, if you experience an unstable image of the stored channel, please refer to Step 8 and 9 on next page. If you live in a poor reception area, the image quality may not be improved.
- While Auto Store in progress, all channels broadcasting are memorized regardless of TV or CATV channels.
- WEST EURO(Germany, Spain, Italy, Netherland, Greece, Portugal, Norway, Denmark, Sweden, Switzerland, Austria, Yugo, Slovenia...), EAST EURO(Russia, Slovak. Rep, Poland, Bulgalia, Hungary...), FRANCE, UK(UK, Ireland), OTHERS(Luxembourg, Monaco...)

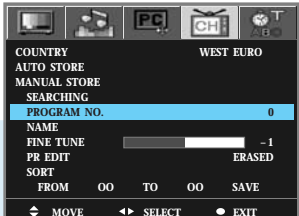
How to Set Manual Store

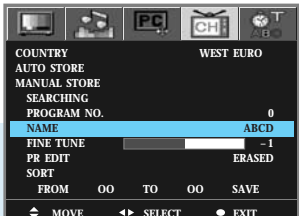
This function allows you to manually edit the desired programs while watching a TV program. If the signal is weak or distorted, you have to fine tune the program manually.

	<p>Press Menu button. Menu items appear on the screen.</p>	
<p>1</p> 	<p>Press Left and Right buttons to select "CH1".</p>	
<p>2</p> 	<p>Press Up and Down buttons to move to "Searching".</p>	
<p>3</p> 	<p>Press Right button to searching the channel, then the frequency changes in order below. <i>Channel Searching proceeds from the current channel to the next channel.</i></p>	
<p>4</p> 	<p>Press Up and Down buttons to move to "Program No".</p>	
<p>5</p> 	<p>Press Left and Right buttons to change the "Program No". Program Number is a current channel.</p>	
<p>6</p> 	<p>Press Up and Down buttons to move to "Name".</p>	
<p>7</p> 	<p>Press Right button to input the program name. You can set up to 0 ~ 9 buttons. A~Z, 0~9, •, -, @, ►, ', %, +, ,, —, ◀, *, /, (,)</p>	

 To move one space (Space).  To delete one character (Delete)

 To move your cursor to the right or left (Direction Key)

* If you do nothing within 5 seconds, you will automatically exit the NAME MENU.

*Go to next page,
If the signal of current program is weak or distorted.*



..... Continued from previous page.

8



Press Up and Down buttons to move to "Fine Tune".

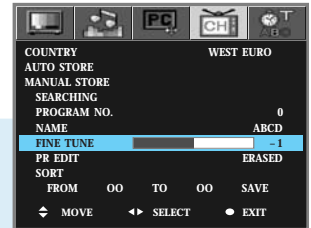

9



Press Left and Right buttons to adjust.
The fine tuned programs are automatically stored.

10



Press Up and Down buttons to move to "PR EDIT".

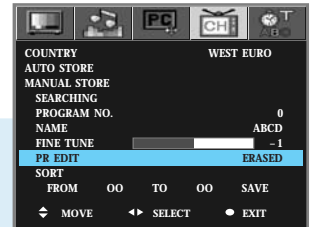

11



Press Left and Right buttons to select "Stored/Erased",
Program number is a current channel.

*Go to step 12,
If users want to Sort the Program Number.*

12



Press Up and Down buttons to move to "From"

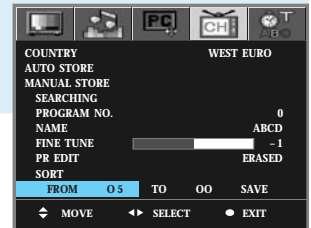

13



Press Left and Right buttons to change the Program No.

14



Press Up and Down buttons to move to "To".

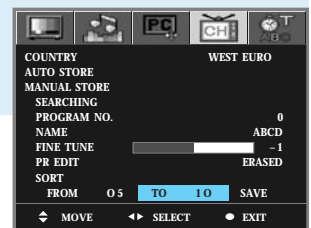

15



Press Left and Right buttons to change the Program No.

Continued on next page

..... Continued from previous page.

- **FROM** : Current Program Number
- **TO** : Change Program Number

ex) From 5, To 10
Change the program number from 5 to 10.

16



Press Up and Down buttons to move to "SAVE".

17



Press Left and Right buttons to select the "Yes"

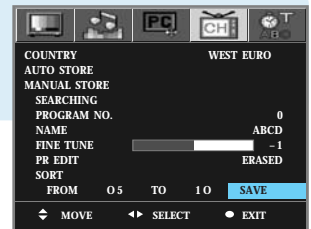

Press MENU button after the setting is done, and Menu goes to the **previous menu**.
If the EXIT button is pressed, the **menu disappears**.



How to Directly Select the PR LIST



Press PR EDIT button.
PR list items appear on the screen.

PROGRAM NO.	NAME	STORED
00		NO
01		YES
02		YES
03	ABC	YES
04		YES
05	CNN	YES
06		YES
07		YES
08		YES
09		YES

⏪ MOVE ⏩ SELECT ● EXIT

1



Press Up and Down buttons to move to "Program No".
** Program No. : 00 ~ 99*

2



Press Left button to select "Stored/Erased".
Program Number is a current channel.

3



Press Right button to select "Program No".

TIP

If you want to change the program name or programme sort, please refer to page 56.

Option Setup



Choosing Your Language	61
How to Set OSD(On-Screen-Display) Display Time	62
How to Select the OSD Background	63
How to Set Sleep Time	64
How to Set Clock	65
How to Set On /Off Time	66
How to Set Key-Lock	68
Displaying Information	69
Teletext Feature	71
Displaying the Teletext Information	72
Selecting Display Options	72



Choosing Your Language

When you start using your TV for the first time, you must select your language preference in order to display main menu and sub menus, etc.



Press Menu button.
Menu items appear on the screen.



1



Press Left and Right buttons to select



2



Press Up and Down buttons to move to
"Language".

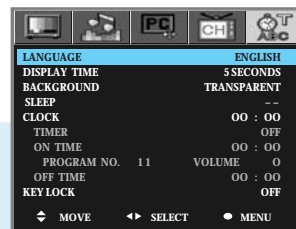

3



Press Left and Right buttons, then the menu
changes in order below.

⇒ ENGLISH ⇒ FRANÇAIS ⇒ DEUTSCH
⇒ ESPAÑOL ⇒ ITALIANO ⇒



Press MENU button after the setting is done, and Menu goes to the previous menu.
If the EXIT button is pressed, the menu disappears.

How to Set OSD(On-Screen-Display) Display Time



Press Menu button.
Menu items appear on the screen.



1



Press Left and Right buttons to select



2



Press Up and Down buttons to move to
"Display Time".



3



Press Left and Right buttons, then the menu
changes in order below.

⇒ 5 SECONDS ⇒ 15 SECONDS ⇒ 20 SECONDS
⇒ 25 SECONDS ⇒ 30 SECONDS ⇒ 40 SECONDS ⇒



Press MENU button after the setting is done, and Menu goes to the previous menu.
If the EXIT button is pressed, the menu disappears.



If you do not press the EXIT button after adjusting the OSD display time, the OSD menu will disappear automatically after the set time.



How to Select the OSD Background

Users can select background type on On-Screen-Display.



Press Menu button.
Menu items appear on the screen.

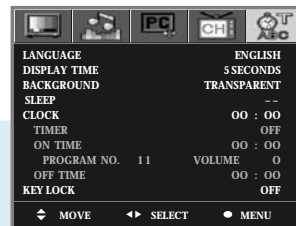

1



Press Left and Right buttons to select

“”.

2



Press Up and Down buttons to move to
“Background”.

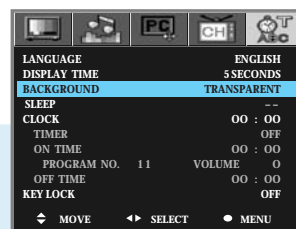

3



Press Left and Right buttons to select
“Transparent/Opaque”.



Press MENU button after the setting is done, and Menu goes to the previous menu.
If the EXIT button is pressed, the menu disappears.

How to Set Sleep Time

This function allows you to automatically turn off your LCD TV after a designated amount of time.

- 

Press Menu button.
Menu items appear on the screen.

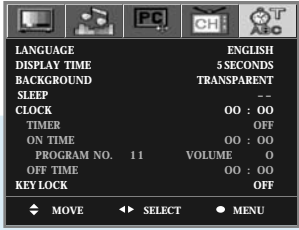

- 1**



Press Left and Right buttons to select
“”.

- 2**



Press Up and Down buttons to move to
“Sleep”.

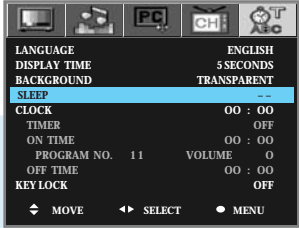

- 3**



Press Left and Right buttons, then the menu changes in order below.
 ⇨ 15 MINUTES ⇨ 30 MINUTES ⇨ 45 MINUTES
 ⇨ 60 MINUTES ⇨ 90 MINUTES ⇨ 120 MINUTES ⇨ OFF(- -) ⇨

- 

Press MENU button after the setting is done, and Menu goes to the previous menu.
If the EXIT button is pressed, the menu disappears.

How To Directly Select SLEEP : Press  button.

The current SLEEP time is first displayed. Whenever you press the button, the setting is changed in order below.
 -- (OFF) ⇨ SLEEP ⇨ 15 MINUTES ⇨ SLEEP 15 ⇨ 30 MINUTES ⇨ SLEEP 30 ⇨ ⇨ SLEEP 120 ⇨

TIP If the sleep time has been set, your TV will display “TURN OFF AFTER 1 MIN” before your TV turns off.



How to Set Clock

You can set the current time so that it may be displayed by pressing the "INFO" button. You must also set a clock if you wish to use the automatic on or off timers.



Press Menu button.
Menu items appear on the screen.

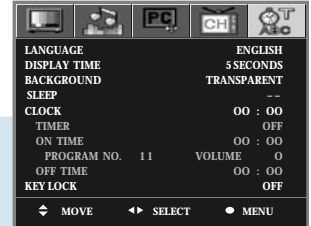

1



Press Left and Right buttons to select
"T ABC".

2



Press Up and Down buttons to move to
"Clock".
then cursors are moved to "Hour" unit.

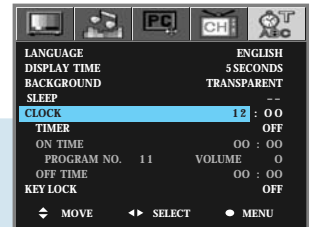

3



Press Left and Right buttons to set
the "Hour".

*Press Up and Down buttons and then go to step 4
if you need to set the "Minute".*

4



Press Left and Right buttons to set
the "Minute".



Press MENU button after the setting is done, and Menu goes to the previous menu.
If the EXIT button is pressed, the menu disappears.



- When the power supply AC main power is cut off, the clock is reset to the value before the Time set.
- User cannot use number(0~9) buttons to set the clock.

How to Set On /Off Time

- This function is allowed you to automatically turn on/off your LCD TV at the preset time.
- If you wish to use this function, make sure to set the timer to ON.



Press Menu button.
Menu items appear on the screen.

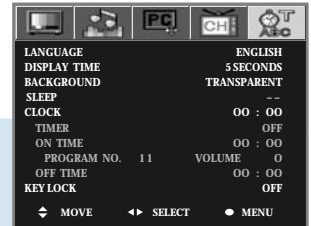

1



Press Left and Right buttons to select

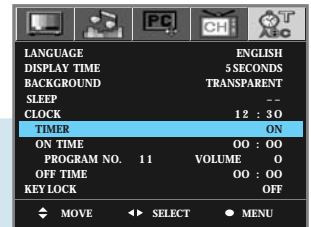

2



Press Up and Down buttons to move to "Timer".

3



Press Left and Right buttons to select "ON".

Press Up and Down buttons and then go to step 4 if you need to set to "On Time".

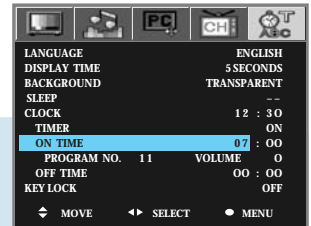

4



Cursors are moved to "ON TIME".
Press Left and Right buttons to set to "Hour".

Press Up and Down buttons and then go to step 5 if you need to set to "Minute".

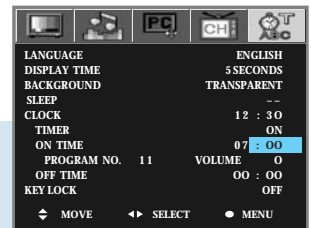

5



Press Left and Right buttons to set to "Minute".

Press Up and Down buttons and then go to step 6 if you need to set to "Program No".



6



Cursors are moved to "Program No".
Press Left and Right buttons to set to "Program No".

Continued on next page



..... Continued from previous page. (Set the volume level at the time when your LCD TV turns on.)

7



Press Up and Down buttons and then go to step 7 if you need to set to "Volume".

Press Left and Right buttons to adjust "Volume".

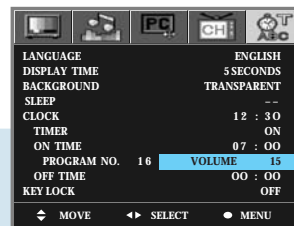

8



Press Up and Down buttons and then go to step 8 if you need to set to "Off Time".

Cursors are moved to "OFF TIME".
Press Left and Right buttons to set to "Hour".



9



Press Up and Down buttons and then go to step 9 if you need to set to "Minute".

Press Left and Right buttons to set to "Minute".



Press MENU button after the setting is done, and Menu goes to the previous menu.
If the EXIT button is pressed, the menu disappears.

TIP

- Regardless of which Input Mode you set On Time in, your LCD TV will turn on in TV Mode only.
- User cannot use number(0~9) buttons to set the On/Off Time.
- If the OFF TIME has been set, your TV will display "TURN OFF AFTER 1 MIN" 1 minute before your TV turns off.

How to Set Key-Lock

- This is to lock the control buttons on the front top of LCD TV.
- After setting the Key-Lock, your TV will work only with the remote control.



Press Menu button.
Menu items appear on the screen.

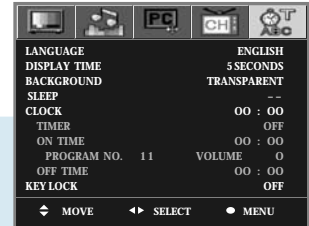

1



Press Left and Right buttons to select



2



Press Up and Down buttons to move to
"key Lock".

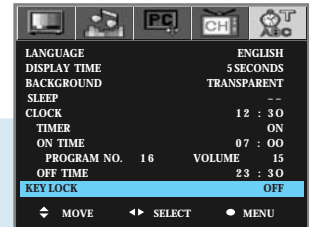

3



Press Left and Right buttons, then the menu
changes in order below.

⇒ Off ⇒ Once ⇒ Always ⇒



Press **MENU** button after the setting is done, and Menu goes to the **previous menu**.
If the **INPUT** button is pressed, the menu **disappears**.

- OFF** : With the lock function off, you can control the TV with both the remote control and the buttons on the TV.
- ONCE** : The lock function will turn off automatically after AC power off/on. Or after power-cut or unplugging the power cord to plug it back in.
- ALWAYS** : With the lock function always on, you can control the TV only with the remote control, not with the buttons on the TV.

TIP

- This function prevents children from controlling the TV when parents are not home.

* How to Unlock Key-Lock :

- Bring up the Menu window using the remote control and switch off the Key-Lock.
- When the remote control is not available, press the Power button within 0.5 second while pressing the Menu button on the top of the TV.



Displaying Information

You can view the channel information and setting status by pressing the “INFO” button on the remote control.



In case of applying TV input
Press INFO button.

PROG NO 5 FREQ 139.25
USER : MONO
CLOCK PM 12 : 30
ON TIME AM 7 : 20
OFF TIME PM 11 : 30



In case of applying VIDEO input
Press INFO button.

VIDEO
CLOCK PM 12 : 30
ON TIME AM 7 : 20
OFF TIME PM 11 : 30



In case of applying S-VIDEO input
Press INFO button.

S-VIDEO
CLOCK PM 12 : 30
ON TIME AM 7 : 20
OFF TIME PM 11 : 30



In case of applying SCART input
Press INFO button.

SCART
CLOCK PM 12 : 30
ON TIME AM 7 : 20
OFF TIME PM 11 : 30



In case of applying COMPONENT input
Press INFO button.

COMPONENT
1080i
CLOCK PM 12 : 30
ON TIME AM 7 : 20
OFF TIME PM 11 : 30



In case of applying PC input
Press INFO button.

The image shows a grey rectangular area representing the TV screen. Inside this area, a white box contains the following text: "PC", "1024 x 768", "CLOCK PM 12 : 30", "ON TIME AM 7 : 20", and "OFF TIME PM 11 : 30".



Teletext Feature

Most TV channels provide written information services via teletext. Information provided includes with the next entry it is same :

- TV programme times
- News bulletins and weather forecasts
- Sports results
- Travel information

Teletext information is often divided between several pages displayed in sequence, which can be accessed by :

- Entering the number
- Selecting a title in a list
- Selecting a coloured heading (FASTTEXT SYSTEM)
- Travel information

Teletext OSD(On-Screen-Display) Picture

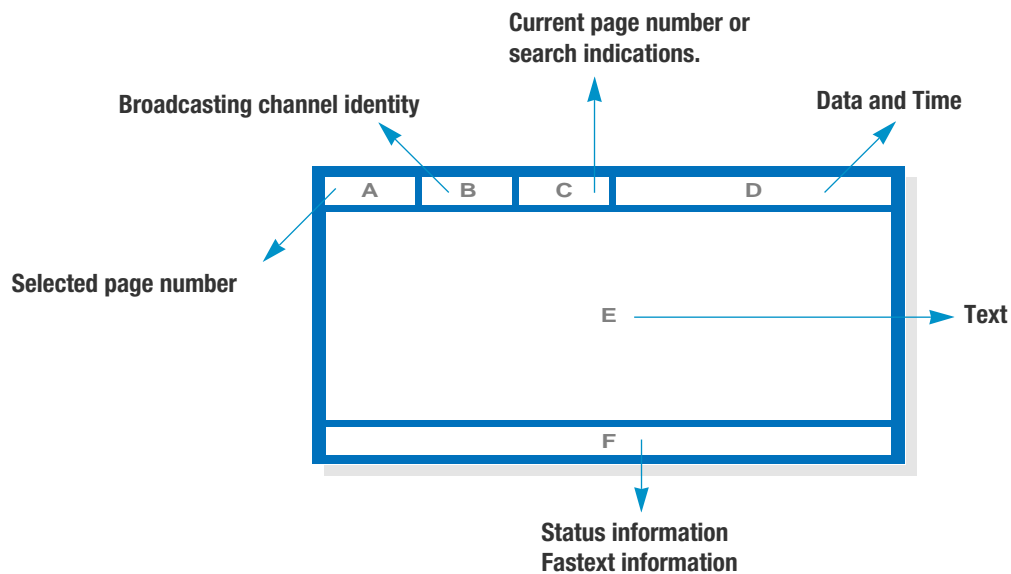

Displaying the Teletext Information

You can display Teletext information at any time on your TV.

For Teletext information to be display correctly channel reception to be stable otherwise

- Information maybe missing or some pages may not be displayed.



Press TTX button to activate the TTX mode.
(The contents of page 252 are displayed.)



If you wish to display the actual broadcast at the same time as the teletext page, press TTX/MIX button.
- If the button is pressed a second time, the function will be deactivated.





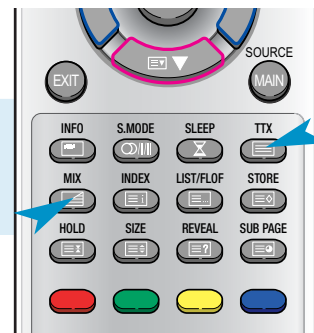



Press TTX button again to exit from the teletext display.





Selecting Display Options

When you have displayed a teletext page, you can have various options to suit you requirements.

BUTTON	DISPLAY(ACTION)
 HOLD	When the secondary pages are displayed in sequence, press the HOLD button. To freeze the current display page, press the HOLD button again to resume.
 SUB PAGE	Displays a secondary page by entering its number.
 REVEAL	Displays concealed text such as answer to quiz games. To return to normal viewing, press this button again.
 SIZE	Whenever you press this button, the letter size of the page will be changed. Once press : The letter of the top half page enlarge to double size. Twice press : The letter of the bottom half page enlarge to double size. Three times press : Return to the normal viewing
 STORE	To store teletext page in list mode.
 LIST/FLOF	Return to LIST or FLOF mode.



BUTTON	DISPLAY(ACTION)
 INDEX	To display the index page, press the INDEX button.
  PAGE UP PAGE DOWN	Displays the next page. Displays the previous page.



While viewing TTX information, PIP, POP, Multi Function is not supported.

Appendix



Troubleshooting	75
Care and Cleaning	77
Product Specifications	78



Troubleshooting

Installation Problems

Symptom	Possible solution
How can I install an antenna?	Refer to pages 23~24 .
TV screen is not clear after installing an indoors antenna.	Indoors antenna may experience poor reception due to surrounding buildings. Please install an outdoors antenna or wireless antenna.
How can I view cable broadcasting?	Please install a cable broadcasting receiver (Converter).

Picture Problems

Symptom	Possible solution
Neither picture nor sound comes up.	Check whether power is on. Check whether the power is cut or whether power cord is properly connected. Try to plug another product's power cord to the outlet the LCD TV is plugged into.
Picture turns on slowly after power is on.	This symptom is not a malfunction. This delay is designed to prevent the distorted and noisy picture when power is on. However, if the picture does not appear more than 5 minutes after power is on, call a service center.
Vertical and horizontal lines and web patterns briefly appear on the picture and shake.	This symptom may be caused by interference from other electric appliances. Please avoid using a cordless phone, hairdryer, and electric drill, etc.
Input Source information only appears on black screen.	Check whether your TV is properly connected to external devices.
Poor reception on some channels.	Check whether you selected proper channels. Try re-orienting your antenna. Ensure LNA is activated.
Black and white on some channels.	Check other channels for black and white screen. Adjust colour.
TV won't turn on.	Ensure the power cord is plugged.
Screen is too bright or too dark.	Adjust brightness.

Auto On does not work.

Ensure to use the remote control or power button on the product to turn off your TV. If you unplug the power cord, the stand-by consumption power becomes 0 (zero), which causes the programmed time to be erased.

After setting the time, I turned TV off and turn it on. The programmed information has been erased.

Ensure to use the remote control or power button on the product to turn off your TV. If you unplug the power cord, the stand-by consumption power becomes 0 (zero), which causes the programmed time to be erased.

Audio Problems

Symptom

Possible solution

Too much noise occurs.

Check whether the audio setting is in the Stereo mode. In the Stereo mode, the sound may be distorted in the area where experiences poor reception or is located far away from a TV broadcasting station.

No sound while viewing a cable channel

Make sure an audio or audio/video component is securely inserted into the appropriate jacks. Check other channels for sound. Check the volume settings on the cable broadcasting receiver.

Picture is OK but sound does not come out.

Try to press volume up/volume down buttons of your remote control.

One of the speakers does not produce sound.

Select sound balance and make proper adjustment. (Page 41)
Check the speaker connection cables.

General

Symptom

Possible solution

Remote control won't work.

Check whether there is a blocking object between the remote control and LCD TV. Make sure your LCD TV is Power On. (In case of normal, LED on the front panel is in Red.)
Check whether batteries are inserted with proper polarities(+, -).
When the batteries are worn out, replace with new ones.

Where does the S-Video cable plug in for audio output?

Connect the two Audio jacks from the S-Video cable to the left and right ports on the Composite.

Strange noises are heard.

Ticking noise during or after watching is caused by the change of ambient environment such as humidity and temperature, which is characterized by plastic products. Strange ticking noise occurs because a signal is suddenly transmitted to the LCD panel. So, this is not a malfunction.

I tried to use the TV screen as a PC monitor but it doesn't work.

Adjust the resolution referring to the standard signal mode table. Check the specification of your video card installed in your PC. If your video card does not work in supported hardware. Try upgrading the video card's driver.



Care and Cleaning

Cabinet Cleaning

Wipe a soft dry cloth.

Do not use inflammables like Benzene or Thinner, or wet clothes.
Do not scratch the panel of TV with a fingernail or pointed object.



Screen Cleaning

Clean the screen with a soft cloth moistened in mild glass detergent and dry with a soft cloth.

Never use any solvent on the screen such as Acetone, Benzene, or Thinner, etc.

Cleaning Inside

When the inside needs to be cleaned, contact a service center or distribution agent where the item is purchased.

It is recommended cleaning is complete before the rainy season.

Product Specifications

MODEL		HQL170WR	HQL200NR
Input/Output	S-Video	1 EA(with common A/V Audio)	1 EA(with common A/V Audio)
	A/V (RCA)	1 EA (Input, with Audio)	1 EA (Input, with Audio)
	Component(Y/Cb/Cr)	1 EA (with Audio)	1 EA (with Audio)
	RF	1 EA	1 EA
	SCART	1 EA (FULL)	1 EA (FULL)
	PC Connector	D-SUB	D-SUB
	Recommended. Resolution	1024 x 768 @ 60 Hz	640 x 480 @ 60 Hz
	Audio	PC Audio	PC Audio
	Headphone	1 EA	1 EA
Power	Supply	AC 100 - 240 V, 50/60 Hz	AC 100 - 240 V, 50/60 Hz
	Consumption	Typical 70 W	Typical 80 W
	Saving	< 5 W	< 5 W
Dimension(W x D x H mm)		560 x 184 x 361 (with stand)	650 x 184 x 450 (with stand)
Weight		6.5 Kg (with stand)	8.5 Kg (with stand)
Control Type		Remote Control, Key Control	Remote Control, Key Control

- Specification is subject to change without notice for performance improvement.



Service Center

USA

Hyundai ImageQuest America

3101 North First Street San Jose, CA 95134

Hyundai tech support

Tel : +800-568-0061, 408-232-8654

Fax : +408- 232-8146

e-mail : syuen@hyundaiqa.com

AVC USA, INC.

777 Mark Street, Wood Dale, IL 60191

Tel : 630-595-0123 / 800-568-0060

Fax : 630-595-2345 / 800-784-9422

e-mail : avctech@avcusa.com

NEW ZEALAND

TRANSTECH DISTRIBUTORS Ltd.

PO Box 12985 Penrose,

Auckland New Zealand

Tel : 09-571-0775

Fax : 09-571-0776

e-mail : LouisG@Transtech.co.nz

WWW : www.transtech.co.nz

AUSTRALIA

Thomas Electronics Australia Pty Ltd.

3 Sheridan Close

Milperra NSW 2214, Australia

Tel : +61 2 9773 7400

Fax : 61 2 9773 7177

Attn : Ms. Shiely Poniman

GERMANY

Hyundai ImageQuest Europe GmbH

Geheimrat Hummel Platz 2

65239, Hochheim, Germany

Tel : 06146 / 904 444

Fax : 06146 / 904 410

e-mail : service@hyundaiq.de

WWW : www.hyundaiq.com

JAPAN

Hyundai ImageQuest JAPAN

Shin-Hibiya Bldg, East 5F 1-3-6

Uchisaiwai-Cho, Chiyoda-ku,

Tokyo, Japan 100-0011

Tel : 03-5157-2286

Fax : 03-5157-2284

e-mail : pjkim@iqt.co.kr

C/S P.J.Kim

www.hyundaiQ.com

Free Manuals Download Website

<http://myh66.com>

<http://usermanuals.us>

<http://www.somanuals.com>

<http://www.4manuals.cc>

<http://www.manual-lib.com>

<http://www.404manual.com>

<http://www.luxmanual.com>

<http://aubethermostatmanual.com>

Golf course search by state

<http://golfingnear.com>

Email search by domain

<http://emailbydomain.com>

Auto manuals search

<http://auto.somanuals.com>

TV manuals search

<http://tv.somanuals.com>